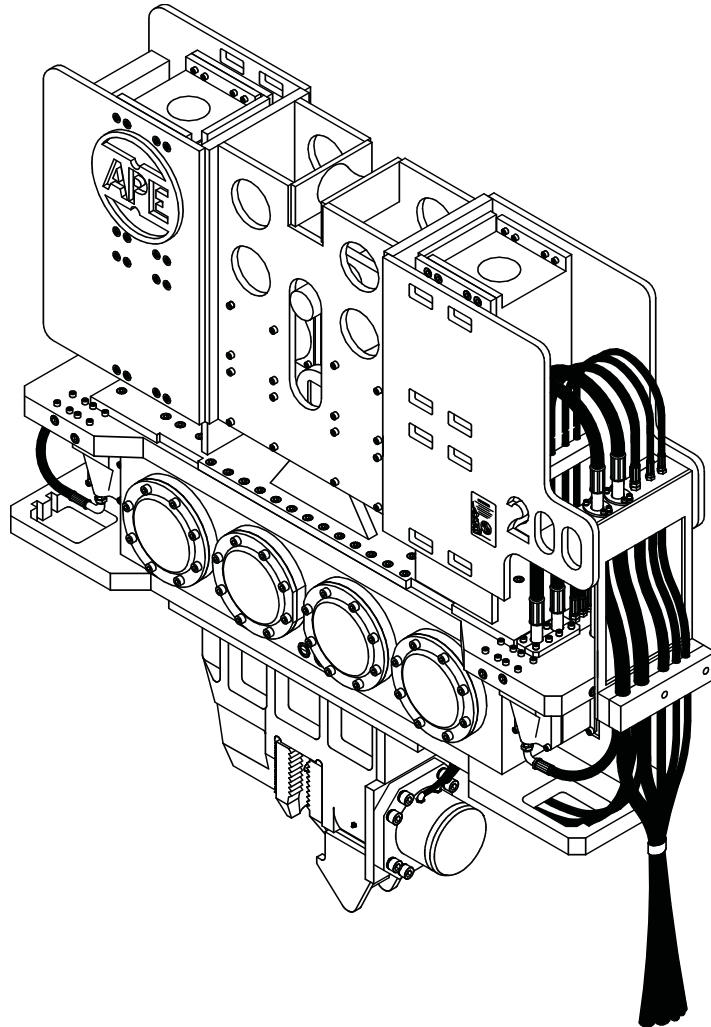




# OPERATION AND MAINTENANCE MANUAL



SERIAL NUMBER:

**MODEL 200, 200T & 200-6 VIBRATORY DRIVER  
WITH MODEL 630 POWER UNIT**

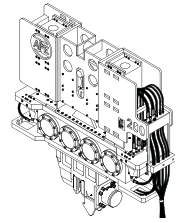




# OPERATION / MAINTENANCE MANUAL

MODEL 200, 200T & 200-6 VIBRATORY DRIVER WITH MODEL 630 POWER UNIT

7032 SOUTH 196th - KENT, WA 98032 - (253) 872-0141 / FAX (253) 872-8710



## Preface

### General

This manual covers the **Model 200 Vibratory Driver/Extractor and the Model 630 Power Unit**. The data provided in this manual gives the necessary information to operate and maintain APE equipment. The listed procedures are to be performed by qualified personnel who have an understanding of the equipment and who follow all safety precautions.

### Guide to Using the Manual

1. Refer to the Table of Contents for the page location of applicable sections.
2. All weights and measurements in this manual are in both English and Metric units.
3. The manual will be revised as necessary to reflect current information.

### Abbreviations

The following are abbreviations used within this manual.

<b>lbs</b>	= Pounds	<b>kg.</b>	= kilograms
<b>psi</b>	= Pounds per Square Inch	<b>kW</b>	= kilowatts
<b>h.p.</b>	= Horse Power	<b>lpm</b>	= liters per minute
<b>gpm</b>	= Gallons Per Minute	<b>mm</b>	= millimeters
<b>rpm</b>	= Revolutions Per Minute	<b>T</b>	=tons (US)
<b>eng.</b>	= Engine	<b>t</b>	= tonnes (metric)
<b>cyl.</b>	= Cylinder	<b>m</b>	= meters
<b>mm</b>	= Millimeter	<b>S/N</b>	= Serial Number
<b>mtg.</b>	= Mounting	<b>P/N</b>	= Part Number
<b>sol.</b>	= Solenoid	<b>mfg,</b>	= Manufacturer
<b>adj.</b>	= Adjustment	<b>OD</b>	= Outer Diameter
<b>CW</b>	= Clockwise	<b>ID</b>	= Inner Diameter
<b>CCW</b>	=Counter-Clockwise		

### Serial Number Locations

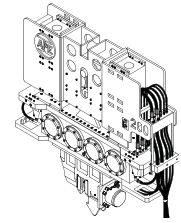
1. **VIBRATOR:** Above and in between the eccentric covers on both sides of the machine.
2. **POWER UNIT:** On back of the hydraulic tank above the APE logo.



# OPERATION / MAINTENANCE MANUAL

MODEL 200, 200T & 200-6 VIBRATORY DRIVER WITH MODEL 630 POWER UNIT

7032 SOUTH 196th - KENT, WA 98032 - (253) 872-0141 / FAX (253) 872-8710



## Table of Contents

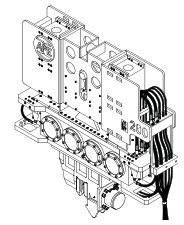
Revision Record .....	i
Preface .....	ii
Table of Contents .....	iii
Safety Precautions .....	vii
Illustration List.....	viii
Table List .....	viii
Warranty .....	ix
<b>I. GENERAL INFORMATION .....</b>	<b>1-1</b>
I-1. Machine Features.....	1-1
I-2. Machine Specifications.....	1-2
A. Model 200, 200T, 200-6 Vibro .....	1-2
B. Model 630 Power Unit.....	1-2
I-3. General Description of 200, 200T-200-6 Vibro.....	1-3
A. Suppressor Housing.....	1-4
B. The Vibrator Gearbox.....	1-5
C. Clamp Attachment.....	1-6
D. Optional Attachments.....	1-7
I-4. General Description of Model 630 Power Unit .....	1-8
<b>II. COMPONENT DEFINITION .....</b>	<b>2-1A</b>
II-1. Vibro Component Identification .....	2-1A
II-2. Vibro Hose Bundle Identification .....	2-4A
II-3. Model 630 Power Unit Skid Identification.....	2-5A
II-4. Quick Disconnect Coupling Identification .....	2-6
II-5. Tool Set Identification .....	2-7
II-6. Caisson Clamp Identification.....	2-8
II-7. Control Panel and Parts .....	2-9
II-8. Remote Pendant and Parts-10.....	2-12
<b>III. LOADING AND UNLOADING .....</b>	<b>3-1</b>
III-1. Vibratory Driver .....	3-1
III-2. Model 630 Power Unit.....	3-1
III-3. In Cases of Damage During Shipment.....	3-1
<b>IV. PREPARATION AND OPERATION .....</b>	<b>4-1</b>
IV-1. Rigging of Vibratory Driver .....	4-1
IV-2. Installing the Clamp Attachment.....	4-1
IV-3. Plumbing the Vibro Hoses to the Power Unit .....	4-2
IV-4. Filling Vibrator Pressure Hoses.....	4-3
IV-5. Bleeding Clamp Attachment Hydraulic Hoses.....	4-3
IV-6. Precautions and Rules for Operation .....	4-4
IV-7. Model 630 Relief Valve Settings Prior to Operation .....	4-5
IV-8. Shut-down Procedures.....	4-7
IV-9. Operation of the Remote Control Pendant.....	4-7
IV-10. Normal Steps to Operate Vibrator .....	4-7
<b>V. MAINTENANCE .....</b>	<b>5-1</b>
V-1. Daily Maintenance Required Prior to Operation.....	5-1
V-2. Checklist After Power Unit Engine Has Started .....	5-1
V-3. Maintenance and Adjustments:..... (75 Hours) .....	5-2
V-4. Maintenance and Adjustments:..... (Eccentric Bearings) .....	5-2
V-5. Maintenance and Adjustments in Severe Conditions.....	5-2
V-6. Lubrication.....	5-2
A. Vibratory Gearbox .....	5-2
B. Clamp Attachment.....	5-2



# OPERATION / MAINTENANCE MANUAL

MODEL 200, 200T & 200-6 VIBRATORY DRIVER WITH MODEL 630 POWER UNIT

7032 SOUTH 196th - KENT, WA 98032 - (253) 872-0141 / FAX (253) 872-8710



## Table of Contents (Continued...)

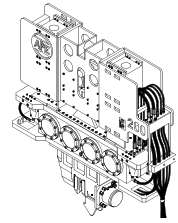
<b>V. MAINTENANCE (Continued...)</b>	
V-7. Power Unit.....	5-3
A. Power Unit Filters, Fluid Types and Capacities.....	5-3
B. Hydraulic Fluid .....	5-4
C. Draining and Filling Hydraulic Fluid Tank.....	5-4
D. Changing Hydraulic Return Filter Element.....	5-5
E. Steps to Remove Filter Element .....	5-5
V-8. Hydraulic Motor - Installation and Start-Up .....	5-6
V-9. Hydraulic Motor Coupling Assembly .....	5-7
<b>VI. VIBRO TROUBLE-SHOOTING .....</b>	<b>6-1</b>
<b>VII. MODEL 630 POWER UNIT .....</b>	<b>7-1</b>
VII-1. Power Unit Skid .....	7-1
VII-2. Power Unit Systems - General Description.....	7-1
VII-3. Engine Layout .....	7-3
VII-4. Hydraulic Circuitry.....	7-5
A. Clamp Circuitry .....	7-5
B. Drive Circuitry .....	7-6
C. Recirculation Filter .....	7-7
D. Oil Cooler.....	7-7
E. Manual Pump.....	7-7
F. Hydraulic Oil Temperature .....	7-7
VII-5. Hydraulic Components.....	7-8
A. Hydraulic Schematic .....	7-8
B. Hydraulic Tank.....	7-9
C. Drive Pumps .....	7-11
D. Drive Manifold.....	7-13
E. Clamp Manifold.....	7-17
F. Hosing: Identification/Routh.....	7-19
VII-6. Electrical Controls: (Understanding How They Work)	
A. Main Circuit Breaker .....	7-20
B. Tachometer .....	7-20
C. Hourmeters .....	7-20
D. Engine Safety Shutdown Switch.....	7-20
E. Murphy "Engine Oil Press" Gage.....	7-20
F. Murphy "Engine Coolant Temp" Gage.....	7-21
G. Murphy "Hyd Oil Temp" Gage.....	7-21
H. Hydraulic oil Level Float Switch .....	7-21
I. Pendant "Emergency Stop" Button .....	7-21
J. Radio "Emergency Stop" Button.....	7-21
K. Pilot Lights .....	7-21
L. Engine control Switch ("OFF-on-START").....	7-22
M. "LOCAL-PENDANT" Switch .....	7-22
N. Governor Control Switches ("RAISE-off-LOWER").....	7-22
O. Clamp Control Switches ("OPEN-off-CLOSE").....	7-22
P. Drive Control Switches ("FORWARD/off/REVERSE").....	7-24
Q. Preparing the Electrical System for Engine Startup .....	7-24
VII-7. Remote Control Pendant .....	7-25
A. Remote Pendant Wiring Diagram .....	7-26
<b>VIII. POWER UNIT UPGRADES.....</b>	<b>8-1</b>
VIII-1. Upgrading to the Murphy Gages.....	8-1
VIII-2. Upgrading Drive and Clamp Switch .....	8-2
VIII-3. Upgrading Radio Controls.....	8-2



# **OPERATION / MAINTENANCE MANUAL**

MODEL 200, 200T & 200-6 VIBRATORY DRIVER WITH MODEL 630 POWER UNIT

7032 SOUTH 196th - KENT, WA 98032 - (253) 872-0141 / FAX (253) 872-8710



## **APPENDIX A - CAT C-18 ENGINE**

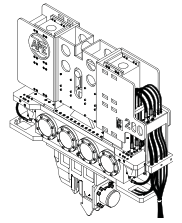
A-1. ENGINE OPERATION INSTRUCTIONS.....	A-1
A. Pre-Start Inspection and Procedures.....	A-1
B. Starting The Engine.....	A-2
C. Engine Operation.....	A-3
D. Determining Cause of Shutdown.....	A-7
A-2. MAINTENANCE RECOMMENDATIONS.....	A-9
A. Lubrication Specifications.....	A-10
B. Fuel Specifications.....	A-11
C. Coolant Specifications.....	A-11
D. Lubrication and Maintenance.....	A-12
E. Electrical System.....	A-13
A-3. ENGINE TROUBLESHOOTING.....	A-14



# **OPERATION / MAINTENANCE MANUAL**

**MODEL 200, 200T & 200-6 VIBRATORY DRIVER WITH MODEL 630 POWER UNIT**

**7032 SOUTH 196th - KENT, WA 98032 - (253) 872-0141 / FAX (253) 872-8710**

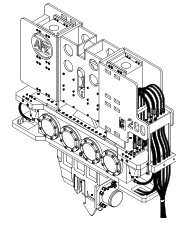




# **OPERATION / MAINTENANCE MANUAL**

MODEL 200, 200T & 200-6 VIBRATORY DRIVER WITH MODEL 630 POWER UNIT

7032 SOUTH 196th - KENT, WA 98032 - (253) 872-0141 / FAX (253) 872-8710



## **Safety Precautions**

(This list of precautions must be followed at all times to ensure personal & equipment safety.)

1. Read this manual from beginning to end before operating or working on this machine.
2. When operating in a closed area, direct the exhaust fumes outside, using pipes.  
**(WARNING:** Breathing exhaust fumes can cause serious injury and even death.)
3. When servicing batteries, avoid any type of spark or open flame. Batteries generate explosive gases during charging. There must be proper ventilation when charging batteries.
4. Never adjust or repair the unit while it is in operation.
5. Make sure the Control Pendant is in the "OFF" position before starting the unit.
6. Remove all tools and electrical cords before starting the unit.
7. Keep oily rags away from the exhaust system.
8. Never store flammable liquids near the engine.
9. Never stand under vibro at any time. Keep your eyes on the vibro when it is in operation. Keep a look out for loose bolts or leaking hydraulic lines.
10. Avoid pulling on hose quick disconnect fittings. Move power unit closer to work if hoses cannot reach. Do not use hoses as a tow line to tug the power unit!
11. Avoid kinks in the hoses. Kinks will cut the hose safety factor by 50 percent.
12. Always wear ear protection.
13. Avoid standing downwind of vibrating piles. Dirt and other matter may become airborne and fall into the unprotected eye.
14. Always wear a hardhat, gloves and safety shoes.
15. Always attach safety line to pile when extracting or hoisting into position.
16. Lay vibro down on ground when not in use.  
**(WARNING)** Never clamp vibro to pile and disconnect from crane line.
17. Do not transport power unit with quick disconnect caps and plugs screwed on to fittings unless the caps and plugs have wire rope safety lines attached. Store in storage box under control panel.

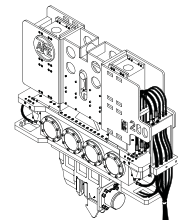




# OPERATION / MAINTENANCE MANUAL

MODEL 200, 200T & 200-6 VIBRATORY DRIVER WITH MODEL 630 POWER UNIT

7032 SOUTH 196th - KENT, WA 98032 - (253) 872-0141 / FAX (253) 872-8710



## Figure List

<u>Figure</u>	<u>Title</u>	<u>Page</u>
1-A.	Machine Features .....	1-1
1-B.	General Description of 200, 200T-200-6 Vibro .....	1-3
1-C.	General Description of Suppressor Housing .....	1-4
1-D.	General Description of Vibratory Gearbox .....	1-5
1-E.	General Description of Clamp Attachment .....	1-6
1-F.	Clamp Attachment Hole Configuration .....	1-6
1-G.	Optional Attachments .....	1-7
1-H.	General Description of Model 630 Power Unit .....	1-8
2-1A.	Model 200 Suppressor Component Location .....	2-1A
2-1B.	Model 200 Gearbox Component Location .....	2-1B
2-1C.	Model 200 Clamp Component Location .....	2-1C
2-A.	Vibro Component Identification .....	2-2
2-B.	Vibro Hose Bundle Identification .....	2-4A
2-C.	Model 630 Power Unit Skid Identification .....	2-5A
2-D.	Quick Disconnect Coupling Identification .....	2-6
2-E.	Tool Set Identification .....	2-7
2-F.	Caisson Clamp Identification .....	2-8
2-G1.	Control Panel Front View .....	2-9
2-G2.	Control Panel Internal View .....	2-10
2-H.	Remote Pendant and Parts .....	2-12
4-A.	Power Unit Coupler Layout .....	4-2
4-B.	Bleeding Clamp Attachment .....	4-3
4-C.	Setting Relief Valve .....	4-5
4-D.	Checking Clamp Pressure Switch Settings .....	4-6
4-E.	Remote Control Pendant Preview .....	4-8
5-A.	Hydraulic Motor - Installation and Start-Up .....	5-6
5-B.	Hydraulic Motor Coupling Assembly .....	5-7
7-A.	Model 630 Power Unit Left Side View .....	7-1
7-B.	CAT C-18 Right Side View .....	7-3
7-C.	CAT C-18 Left Side View .....	7-4
7-D.	Model 630 Control Panel .....	7-7
7-E.	Model 630 Hydraulic Schematic .....	7-8
7-F.	Model 630 Hydraulic Tank Fitting Callout .....	7-9
7-G.	Model 630 Tank Detail .....	7-10
7-H.	Model 630 Rear of Engine w/ Drive Pumps .....	7-11
7-I.	Model 630 Drive Manifold (APE P/N 513028) .....	7-13
7-J.	Model 630 Drive Manifold (Continued...) .....	7-15
7-K.	Model 630 Clamp Manifold (APE P/N 523002) .....	7-17
7-L.	Remote Control Pendant .....	7-25
7-M.	Remote Pendant Wiring Diagram .....	7-26

## Table List

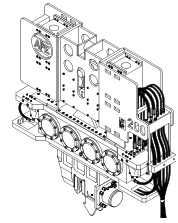
<u>Table</u>	<u>Title</u>	<u>Page</u>
1-A.	Machine Specifications - Model 200, 200T-200-6 Vibro .....	1-2
1-B.	Machine Specifications - Model 630 Power Unit .....	1-2
2-A.	Vibro Component Identification .....	2-2
2-A.	Vibro Component Identification Continued .....	2-3
2-B.	Vibro Hose Bundle Identification .....	2-4B
2-C.	Model 630 Power Unit Skid Identification .....	2-5B
2-D.	Quick Disconnect Coupling Identification .....	2-6
2-E.	Tool Set Identification .....	2-7
2-F.	Caisson Clamp Identification .....	2-8
2-G.	Control Panel and Parts .....	2-11
2-H.	Remote Pendant and Parts .....	2-12
5-A.	Power Unit - Filters, Fluid Types and Capacities .....	5-3
6-A.	Vibro Trouble-Shooting Index .....	6-1
7-A.	CAT C-18 Identification .....	7-3
7-B.	Model 630 Hydraulic Tank Fitting Callout .....	7-9
7-C.	Model 630 Drive Pump Identification .....	7-12
7-D.	Model 630 Drive Manifold Identification .....	7-14
7-E.	Model 630 Clamp Manifold Identification .....	7-18
7-F.	Model 630 Hose Identification and Routing .....	7-19



# **OPERATION / MAINTENANCE MANUAL**

MODEL 200, 200T & 200-6 VIBRATORY DRIVER WITH MODEL 630 POWER UNIT

7032 SOUTH 196th - KENT, WA 98032 - (253) 872-0141 / FAX (253) 872-8710



## **Warranty**

### **American Piledriving Equipment, Inc. STANDARD WARRANTY**

American Piledriving Equipment, Inc. (APE) warrants new products sold by it to be free from defects in material or workmanship for a period of one year after the date of delivery to the first user and subject to the following conditions:

APE's obligation and liability under this WARRANTY is expressly limited to repairing or replacing at APE's option, any parts which appear to APE upon inspection to have been defective in material or workmanship. Such parts shall be provided at no cost to the user, at the business establishment of APE or the authorized APE distributor of the product during regular working hours. **This WARRANTY, shall not apply to component parts or accessories of products not manufactured by APE** and which carry the warranty of the manufacturer thereof, or to normal maintenance (such as engine tune-up) or normal maintenance parts (such as filters).

Replacement or repair parts installed in the product covered by this WARRANTY are warranted only for the remainder of the warranty as if such parts were original components of said product. AMERICAN PILEDIVING EQUIPMENT, INC. makes no other warranty, expressed or implied and makes no warranty of merchantability of fitness for any particular purpose.

APE's obligation under this WARRANTY shall not include any transportation charges, costs of installation, duty, taxes or any other charges whatsoever, or any liability for direct, indirect, incidental or consequential damage or delay. If requested by APE, products or parts for which a warranty claim is made are to be returned transportation prepaid to APE. Any improper use, including operation after discovery of defective or worn parts, operation beyond rated capacity, substitution of any parts whatsoever, or parts not approved by APE or any alteration or repair by others in such manner as in APE's judgment affects the product materially and adversely, shall void this warranty.

**NO EMPLOYEE OR REPRESENTATIVE IS AUTHORIZED TO CHANGE THIS WARRANTY IN ANY WAY OR GRANT ANY OTHER WARRANTY UNLESS SUCH CHANGE IS MADE IN WRITING AND SIGNED BY AN OFFICER OF APE, INC.**

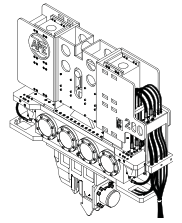
**ANY TYPE OF WELDING ON EQUIPMENT  
WILL VOID THE WARRANTY**



# OPERATION / MAINTENANCE MANUAL

MODEL 200, 200T & 200-6 VIBRATORY DRIVER WITH MODEL 630 POWER UNIT

7032 SOUTH 196th - KENT, WA 98032 - (253) 872-0141 / FAX (253) 872-8710



## I. GENERAL INFORMATION

### I-1. Machine Features - Model 200, 200T & 200-6 Vibratory Driver

Patented breakthrough suppressor cuts down weight while increasing line pull.

Shorter than other vibros in its class. Gain more headroom and reach.

Heavy duty lifting section eliminates problems associated with shackles and pins.

150 Ton pull! Twice the pulling ability of other vibros.

Suppressor is modular and can be removed to reduce suspended weight & Height by switching suppressor housings.

Hydraulic motors are recessed which eliminates the need for bolted on guards. Less parts-less problems.

Gear box incorporates a machined O-ring groove to seal the top plate with no leaky gaskets.

One piece eccentric/ gear design eliminates bolts, keyways, splines and pins.

Rifle bored top plate eliminates unwanted hoses that can cause serious downtime. (15-less hoses).

Four eccentrics filled with "heavy metals" produce more amplitude with less parts.

Computer designed gear-box is perfectly balanced with very low center of gravity. Release crane line without the worry of bending piles.

Giant spherical bearings are five times larger than those found on other machines.

The vibro can be shipped fully assembled on a Boeing 747 aircraft.

High speed gear train will allow vibro to operate off of many different power units.

Gear box drilled to accept attachments manufactured by APE and by other manufacturers.

Heavy cylinder needs no guards and all hoses are tucked out of harms way. The one piece design eliminates rear seals, tie rods and nuts.

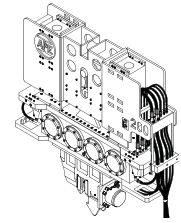
**Figure 1-A. Machine Features**



# OPERATION / MAINTENANCE MANUAL

MODEL 200, 200T & 200-6 VIBRATORY DRIVER WITH MODEL 630 POWER UNIT

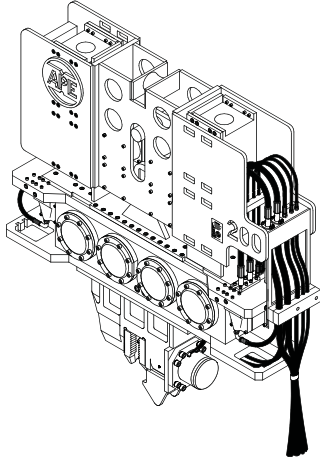
7032 SOUTH 196th - KENT, WA 98032 - (253) 872-0141 / FAX (253) 872-8710



## I. GENERAL INFORMATION (Continued...)

### I-2. Machine Specifications

#### I-2A. Model 200, 200T & 200-6 Vibro - (Table 1-A.)



Specifications	Units	200	200T	200-6
Eccentric Moment	in-lbs/kg-m	4,400/500	5,200/600	6,600/760
Drive Force	ton/kN	202/1,797	239/2,212	303/2,700
Frequency	cpm/htz	1,650/27.5	1,650/27.5	1,650/27.5
Centrifugal Force	ton/kN	170/1,693	201/2002	255/2002
Amplitude w/o attachment	in/mm	1.17/29.7	1.3/33	1.44/36.5
Pile Gripping Force	ton/kN	250/2,491	250/2,491	250/2,491
Caisson Gripping Force	ton/kN	500/4,982	500/4,982	500/4,982
Line Pull For Extraction	ton/kN	150/1494	150/1494	150/1494
Hydraulic Hose Length	feet/meter	150/45.7	150/45.7	150/45.7

\* Add 2200 lbs. to suspended weight when using bias weights.

\*\* Frequency is adjustable at control panel or hand held pendant.

#### I-2B. Model 630 Power Unit - (Table 1-B.)

##### Model 630



Engine	Caterpillar C-18
Maximum Power	630 HP (470 kW)
Operating Speed	800 to 2350 rpm
Maximum Drive Pressure	4,800 psi (331 bar)
Maximum Hyd. Flow-Forward	0 to 180 gpm (682 lpm)
Maximum Hyd. Flow-Reverse	0 to 180 gpm (682 lpm)
Clamp Pressure	4,800 psi (331 bar)
Clamp Pump Flow @ 2200 rpm	6.5 gpm (25 lpm)
Weight	20,000 lbs (9,071 kg)
Length	156 " (3,962 mm)
Width	72" (1,829 mm)
Height	101" (2,565 mm)

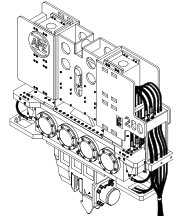
**Dimensions may vary depending on the year and model.  
Consult the factory for certifications on unit being used.**



# OPERATION / MAINTENANCE MANUAL

MODEL 200, 200T & 200-6 VIBRATORY DRIVER WITH MODEL 630 POWER UNIT

7032 SOUTH 196th - KENT, WA 98032 - (253) 872-0141 / FAX (253) 872-8710



## I. GENERAL INFORMATION (Continued...)

### I-3. General Description of Model 200, 200T & 200-6 Vibro

The **APE Model 200**, 200T & 200-6 is a variable frequency vibratory pile driver/extractor designed to drive and extract all types of piles including sheet, pipe, timber, concrete, H-beam, I-beam and steel plates. In addition, the vibrator can be used for soil compaction, installing well casings and installation of tiebacks and wick drains.

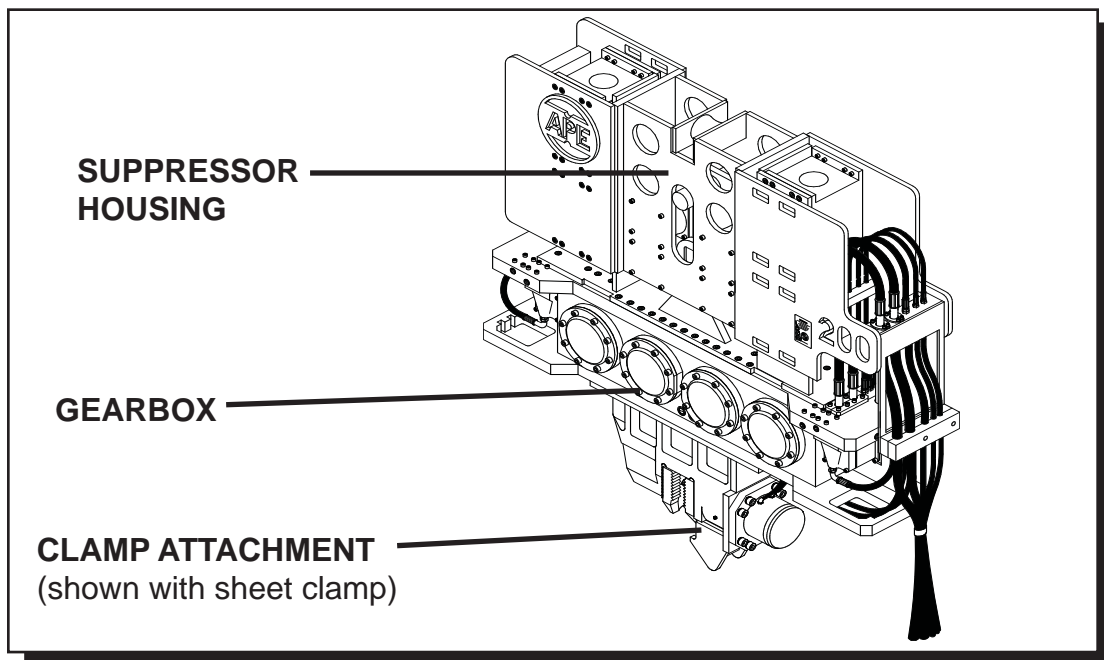
The Model 200, 200T, 200-6 is especially suited for driving or extracting piles that are near buildings or other structures. This is because the Model 200, 200T & 200-6 vibrates at higher frequencies and thus is less damaging to surrounding soils.

The three major parts to the Model 200 are as follows:

- A.) The Suppressor housing.
- B.) The Gearbox.
- C.) The Clamping Attachment,

### Figure 1-B. General Description of 200, 200T & 200-6 Vibro

**Note:** The 200 and 200T have four eccentrics while the 200-6 has six eccentrics.

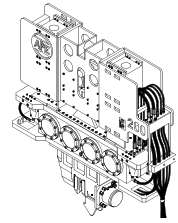




# OPERATION / MAINTENANCE MANUAL

MODEL 200, 200T & 200-6 VIBRATORY DRIVER WITH MODEL 630 POWER UNIT

7032 SOUTH 196th - KENT, WA 98032 - (253) 872-0141 / FAX (253) 872-8710



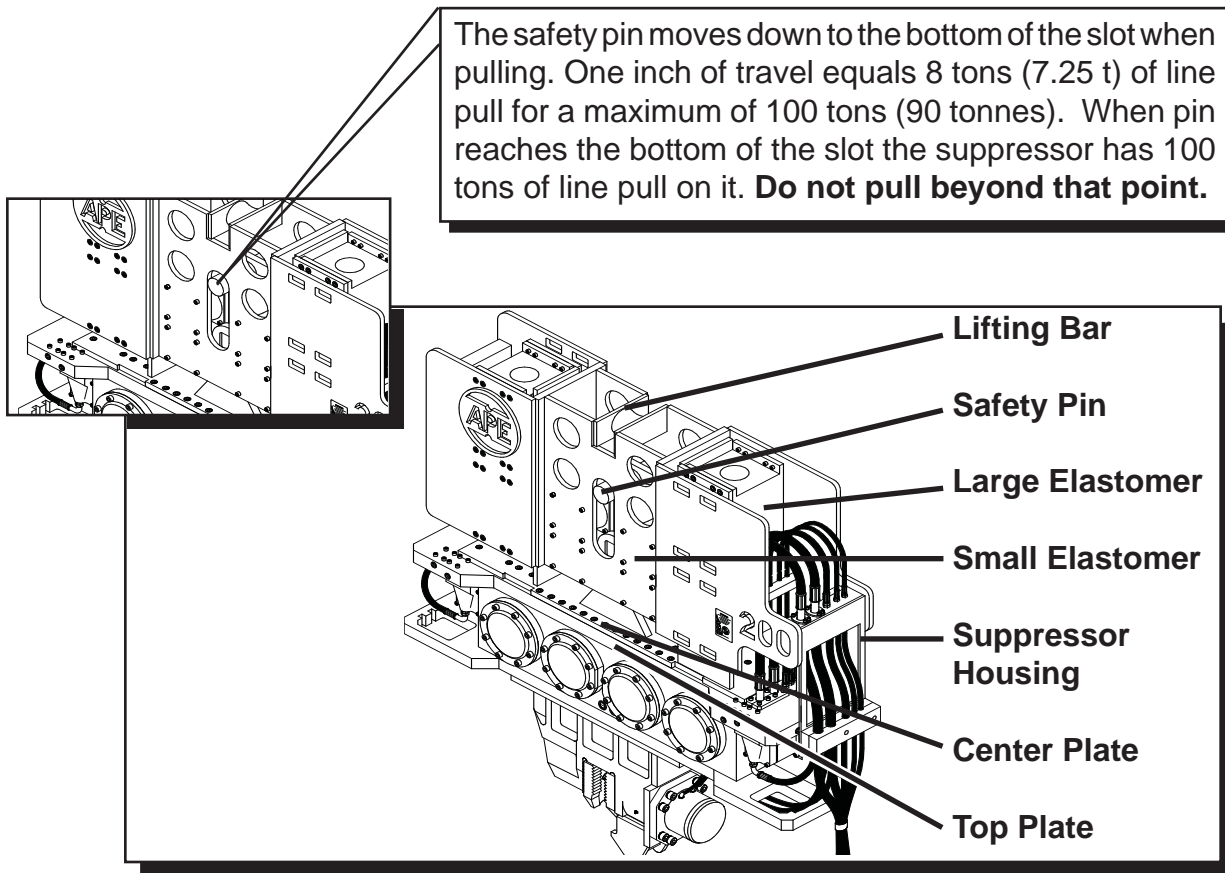
## I. GENERAL INFORMATION (Continued...)

### I-3A. The Suppressor Housing

The suppressor housing of the **200, 200T & 200-6 APE Vibrator** is a patented multistage system consisting of four large rubber elastomers and eight small elastomers. The large rubber elastomers (technically called the first stage) are used during all driving operations and light to medium extraction. The second stage is made up of eight small high capacity elastomers that do not engage until the crane has pulled approximately 50 tons (45 tonnes) of line pull. A large safety pin fitted inside a view slot indicates total line pull in tons. The safety pin travels down in the view slot during the extraction process. One inch of travel is equal to eight tons of line pull. (**WARNING! Hard pulling for long periods of time will heat and damage the large elastomers. The heat generated from constant heavy line pull will destroy the chemical bond between the rubber and mounting plate which will cause the large elastomer to fail.**)

When engaged in hard extracting, break every 15 minutes to allow elastomers to cool.

**Figure 1-C. General Description of Suppressor Housing**

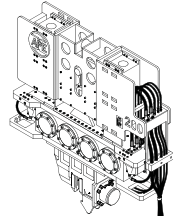




# OPERATION / MAINTENANCE MANUAL

MODEL 200, 200T & 200-6 VIBRATORY DRIVER WITH MODEL 630 POWER UNIT

7032 SOUTH 196th - KENT, WA 98032 - (253) 872-0141 / FAX (253) 872-8710

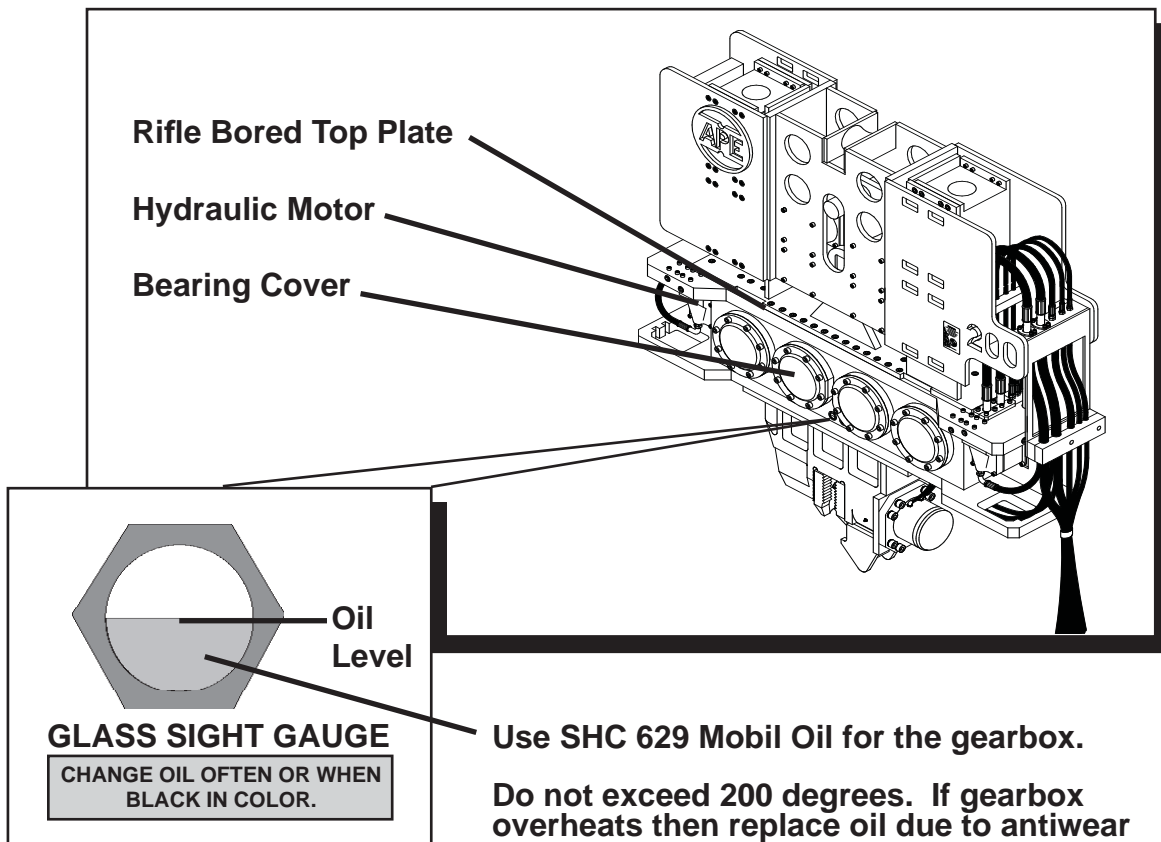


## I. GENERAL INFORMATION (Continued...)

### I-3B. The Vibrator Gearbox

The vibrator gearbox contains four high-amplitude eccentric weights (six on the 200-6) cast in one piece with the gear. This design is unique to the industry and was developed by the engineers of APE to solve a number of problems associated with other types of vibrator machines. Both the eccentric and the drive gears have been helically cut to provide high speed operation with reduced noise and wear. Vibration is caused by the vertical movement created when the eccentrics are rotated. The eccentric and drive gears are all driven in line by two Rexroth motors tucked in on the outboard side of the gearbox. The motors are recessed for maximum protection. The eccentrics rotate on four shafts housed by eight giant spherical bearings. The gears and bearings receive lubrication as a result of the fluid splashing inside the gearbox when the gears are rotated. The oil level is quickly determined by looking at the site gauge. The Model 200, 200T & 200-6 can be operated under water to a depth of 30 feet (9m) without modifications. (Consult factory for depths below 30 feet.)

**Figure 1-D. General Description of Vibrator Gearbox**

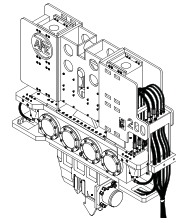




# OPERATION / MAINTENANCE MANUAL

MODEL 200, 200T & 200-6 VIBRATORY DRIVER WITH MODEL 630 POWER UNIT

7032 SOUTH 196th - KENT, WA 98032 - (253) 872-0141 / FAX (253) 872-8710

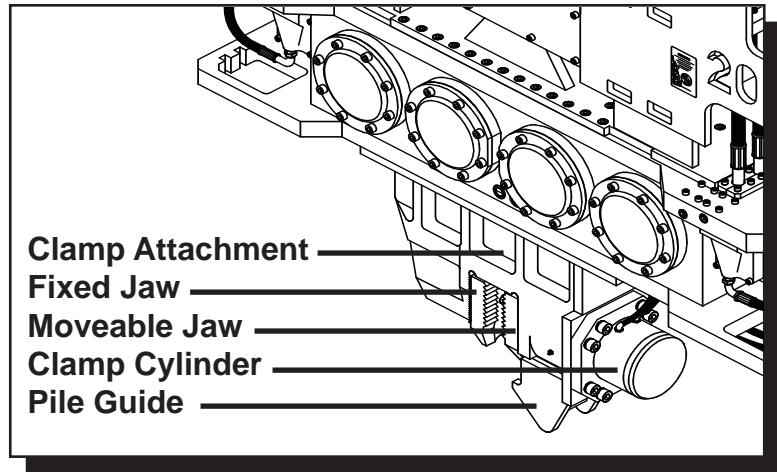


## I. GENERAL INFORMATION (Continued...)

### I-3C. The Clamp Attachment

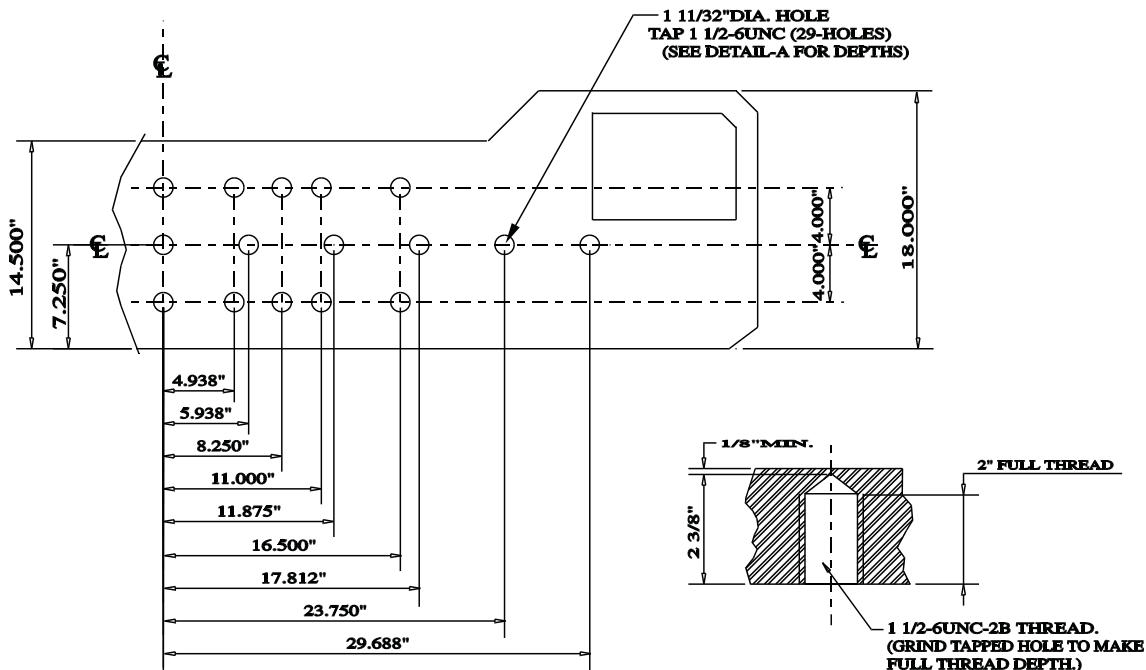
The APE 200, 200T & 200-6 comes with a **standard sheet pile clamp attachment**. The clamp contains two gripping jaws. One is "fixed" and one is "movable". A large hydraulic cylinder operates the moveable jaw with up to 250 tons (225 tonnes) of clamping force depending on clamp pump relief pressure. The jaws open and close by turning a switch on the remote control pendant, or may be operated by turning the switch at the main control panel, mounted behind one of the doors on the power unit. The valve can be manually operated with a screwdriver if all electrical fails.

**Figure 1-E. General Description of Clamp Attachment**



The APE standard sheet pile clamp can be fitted with jaws to fit many different types of piles including sheet piles, H-Beams, steel plates, steel rods, pipe piles, wood piles and concrete piles. (Contact APE or your local APE distributor for more information on clamp attachments for special pile types.)

**Figure 1-F. Clamp Attachment Hole Configuration**



**DETAIL-A**

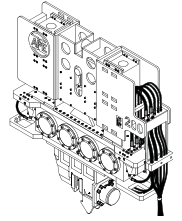




# OPERATION / MAINTENANCE MANUAL

MODEL 200, 200T & 200-6 VIBRATORY DRIVER WITH MODEL 630 POWER UNIT

7032 SOUTH 196th - KENT, WA 98032 - (253) 872-0141 / FAX (253) 872-8710

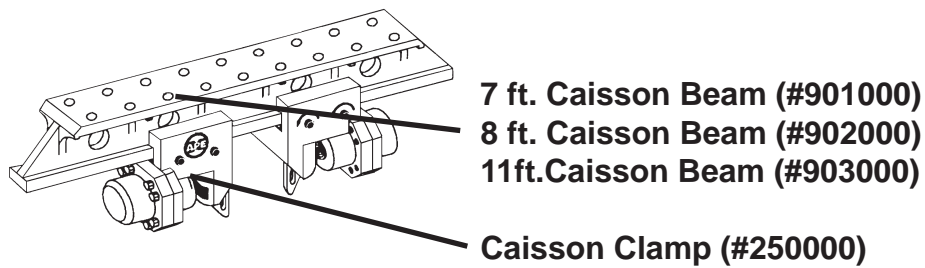


## I. GENERAL INFORMATION (Continued...)

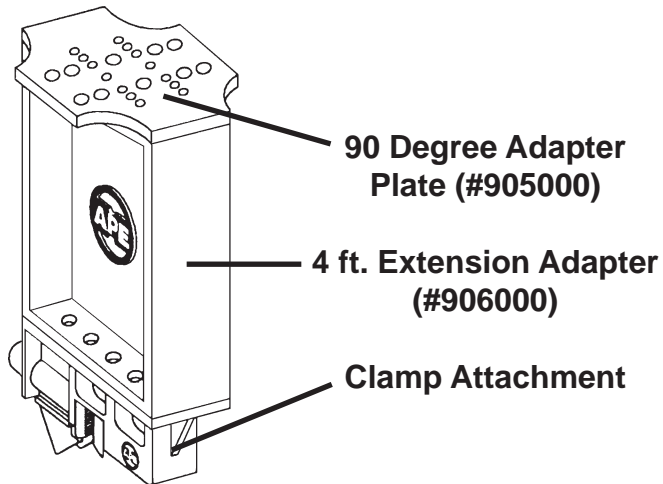
### I-3D. Optional Attachments

The following are some of the optional attachments for APE & J&M Vibratory Driver/Extractors. (Contact APE or your local APE distributor for more information about these and other available equipment.)

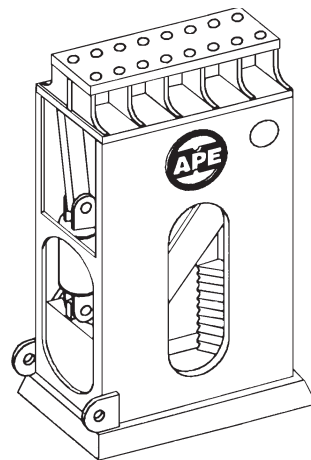
**Figure 1-G. Optional Attachments**



**APE CAISSON CLAMP**



**APE 90 DEGREE  
ADAPTER WITH EXTENSION**



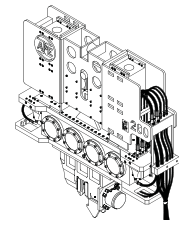
**APE DELUXE WOOD/  
CONCRETE CLAMP  
(#907000)**



# OPERATION / MAINTENANCE MANUAL

MODEL 200, 200T & 200-6 VIBRATORY DRIVER WITH MODEL 630 POWER UNIT

7032 SOUTH 196th - KENT, WA 98032 - (253) 872-0141 / FAX (253) 872-8710



## I. GENERAL INFORMATION (Continued...)

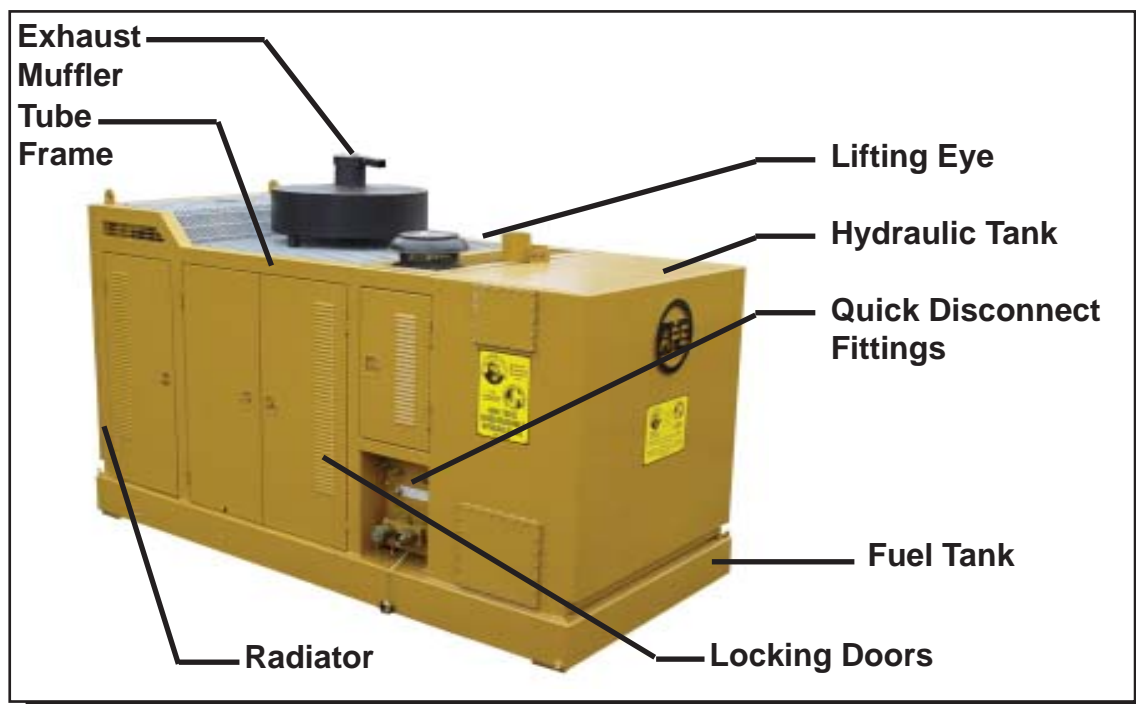
### I-4. General Description of Model 630 Power Unit

The vibrator runs off the APE 630 power unit. The APE 630 has a CAT 630 horsepower engine. The engine is mounted to a tubular frame that also serves as a diesel fuel tank. A sheet metal and tube frame covers the engine and is equipped with locking doors for protection from the environment. A control panel is located behind one of the doors and comes complete with a 50 foot (15m) control pendant. There are two hydraulic tanks on the power unit. One is the main tank and the other is a storage tank for extra oil in case the main tank becomes depleted.

The Vibrator is connected to the power unit via five hydraulic hoses.

**HOSES** - The 1 1/2" ID (38mm) hose is the pressure line and the 2" ID (50mm) is the return line for the vibrator motors. The two 3/8" ID (9.5mm) hoses are for the clamp system. The 1" ID (25mm) hose is for the vibrator motor case drain line. The hoses are attached to the power unit by connecting the "quick disconnect fittings" on the end of the hoses leading from the vibrator. The fittings go on only one way so there is no chance of hooking up the hoses improperly.

**WARNING:** Before installing quick disconnects, clean with ether or a clean rag. Make sure you seat the quick disconnect fittings all the way tight. Failure to tighten the quick disconnects will stop the flow of oil and will prevent the vibro from operating. Failure to tighten the clamp fittings completely tight will cause the jaws to either not open or not close. If this happens you may have to crack the fitting and bleed off the pressure to release the quick disconnects.



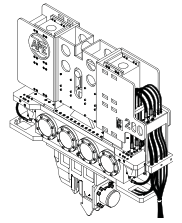
**Figure 1-H. General Description of Model 630 Power Unit**



# OPERATION / MAINTENANCE MANUAL

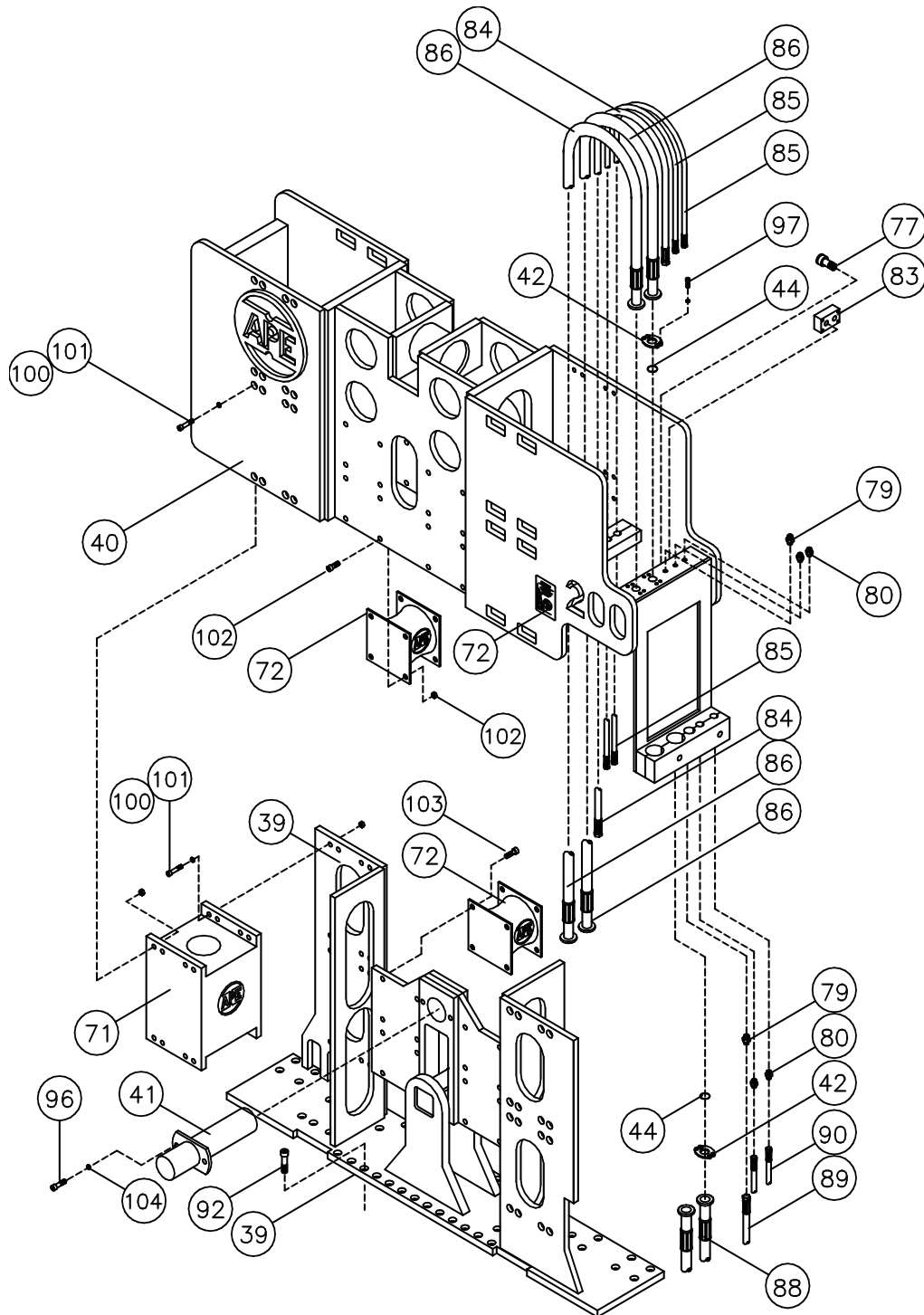
MODEL 200, 200T & 200-6 VIBRATORY DRIVER WITH MODEL 630 POWER UNIT

7032 SOUTH 196th - KENT, WA 98032 - (253) 872-0141 / FAX (253) 872-8710

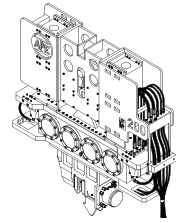


## II. COMPONENT DEFINITION (Continued...)

### II-1. Vibro Component Identification

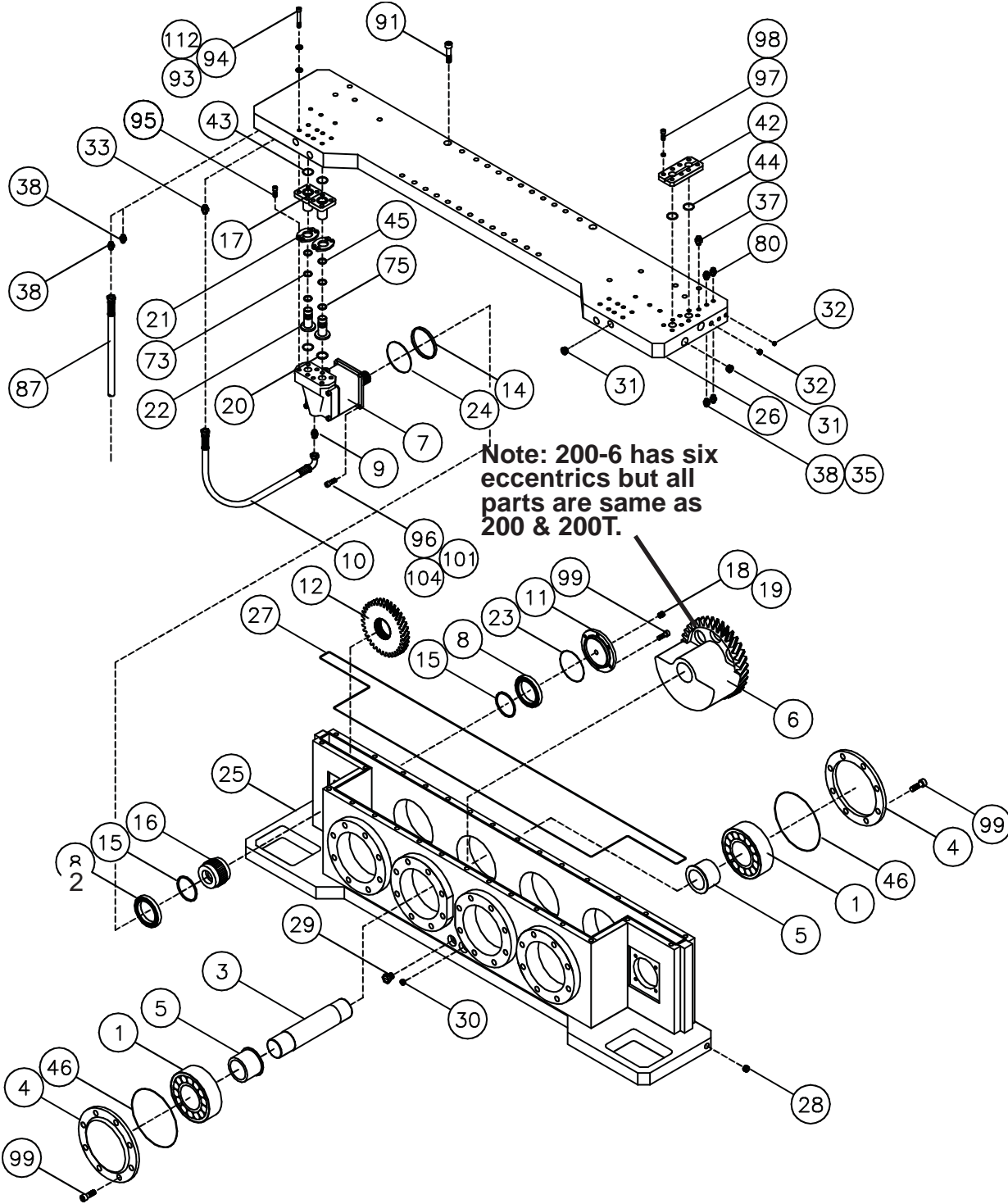


**Figure 2-1A. Model 200 Suppressor Component Location**



## II. COMPONENT DEFINITION (Continued...)

### II-1. Component Identification. (Continued...)



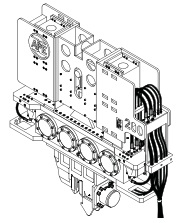
**Figure 2-1B. Model 200 Gearbox Component Location**



# OPERATION / MAINTENANCE MANUAL

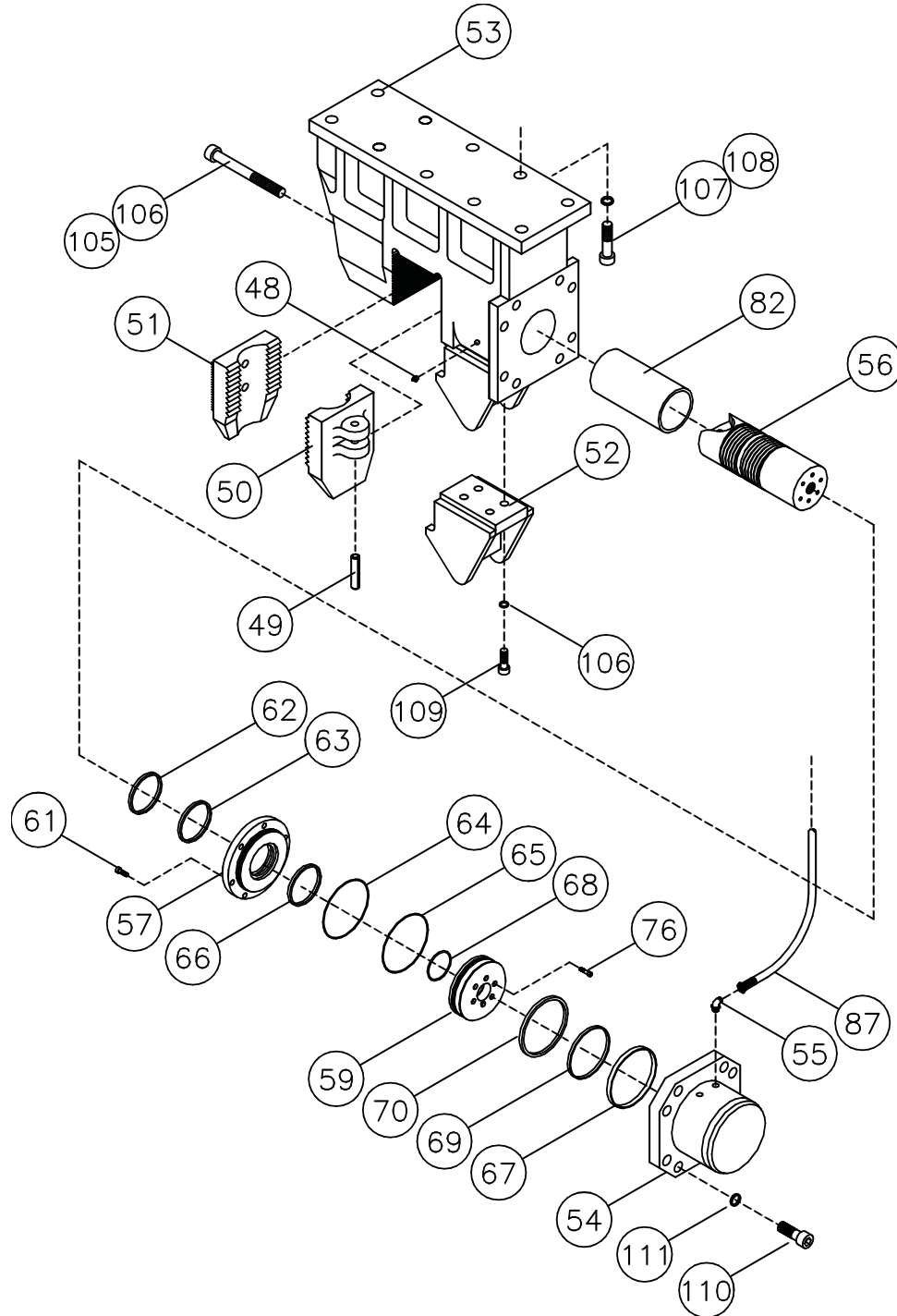
MODEL 200, 200T & 200-6 VIBRATORY DRIVER WITH MODEL 630 POWER UNIT

7032 SOUTH 196th - KENT, WA 98032 - (253) 872-0141 / FAX (253) 872-8710



## II. COMPONENT DEFINITION (Continued...)

### II-1. Component Identification. (Continued...)



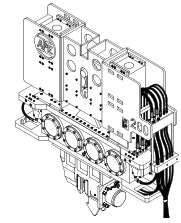
**Figure 2-1C. Model 200 Clamp Component Location**



# OPERATION / MAINTENANCE MANUAL

MODEL 200, 200T & 200-6 VIBRATORY DRIVER WITH MODEL 630 POWER UNIT

7032 SOUTH 196th - KENT, WA 98032 - (253) 872-0141 / FAX (253) 872-8710



## II. COMPONENT DEFINITION (Continued...)

### II-1. Vibro Component Identification

The following is a general listing of the APE 200, 200T & 200-6 Major components and part numbers. (Please see Figure 2-A. for component location.) Note: The 200-6 has two additional eccentrics and related components.

**Table 2-A. Vibro Component Identification.**

Item	Qty	Description	Part #
1	8	Model 200 Eccentric Bearing	#121001
2	2	Gear Spacer - Narrow	#122011
3	4	Eccentric Shaft	#121003
4	8	Eccentric Bearing Cover	#121004
5	8	Eccentric Bearing Sleeve	#121005
6	4	Eccentric Weight - Model 200	#131007
7	4	Vibratory Motors	#122001
8	4	Motor Bearing	#122002
9	2	Fitting#F40X-S-8-12MJICxMBSPP	#122003
10	2	Motor Hose Assembly	#122004
11	2	Motor Bearing Cover	#122005
12	1	Drive Gear - Left	#122006
13	1	Drive Gear - Right	#122007
14	2	Bearing Spacer	#122008
15	2	Gear Spacer	#122009
16	2	Gear Carrier	#122010
17	4	Hydraulic Flange Couplers	#152012
18	2	#10 SAE Breather Plug	#122014
19	1	Breather Valve	#122015
20	4	Parker O-Ring #2-225	#122027
21	4	1 1/4 Code 62 Split Flange	#122017
22	--	Top Plate Piston Plungers	#122018
23	2	Motor Cover O-Ring Parker#2-258	#122019
24	2	Motor O-Ring Parker #2-163	#122020
25	1	Vibratory Gearbox	#153001
26	1	Top Plate	#153002
27	1	.070 C/S BUNA 70 Cord x 13'-0"	#123003
28	2	Magnetic Drain Plug	#123004
29	1	Sight Gauge	#123005
30	1	Gearbox Oil Level Plug	#123006
31	8	#20 SAE Socket Drive Plug	#123007
32	10	#8 SAE Socket Drive Plug	#123008
33	2	#8 SAE / #8 JIC Fitting	#123009
34	--	-----	-----
35	2	#6 JIC Cap	#123011
36	1	Oil Fill Plug	#123012
37	1	#12 SAE / #12 JIC Fitting	#123013
38	4	#8 SAE / #6 JIC Fitting	#123014
39	1	Lifting Bracket	#123015
40	1	Outer Suppressor Housing	#330101
41	1	Lift Pin	#123017
42	3	Double Split Flange	#123018
43	4	Parker O-Ring #2-226	#123104
44	6	Flange O-Ring #2-225	#123020
45	4	Parker O-Ring #2-218	#123105
46	8	Bearing Cover O-Ring #2-276	#123101

Item	Qty	Description	Part #
47	1	Bolt Kit - Model 200	#154000
48	1	1/8" Grease Zert	#221001
49	1	Jaw Pin	#221002
50	1	Movable Jaw	#221005
51	1	Fixed Jaw	#221011
52	1	Sheet Pile Guide Assy.	#221017
53	1	Clamp Body	#231101
54	1	Clamp Cylinder - Model 200	#232001
55	2	#6 SAE / #6 JIC 45 Deg. Fitting	#222002
56	1	Plunger Model 150	#222301
57	1	Cylinder End Cap	#222302
58	1	Plunger Model 180	#232301
59	1	Cylinder Piston	#222303
60	--	-----	-----
61	--	Bolt-SHCS 5/8"NF x 1" (Machined)	#124209
62	1	6" Rod Wiper #959-53	#222015
63	1	Type B Polypak #25006000-3758	#222016
64	1	Back-Up Ring #8-367 N300-90	#222017
65	2	O-Ring 70 Duro #2-367	#222018
66	1	Wear Ring #W125-6250-750	#222014
67	1	Piston Ring #TFE-R-30008 Bronze	#222011
68	1	Parker O-Ring #2-356	#222013
69	1	Square Ring #4426	#222012
70	1	Wear Ring #W125-8000-750	#222020
71	4	Large Elastomers	#321003
72	8	Small Elastomers	#321004
73	4	Backup Ring #8-218	#123106
74	1	Center Pin	#321006
75	4	Environmental O-Ring #2-028	#123107
76	6	Bolt-SHCS 7/8"NC x 2"	#124218
77	1	Pop-Off Valve	#321009
78	2	Danger Sticker - Small	#000109
79	1	#12 SAE / #12 JIC Fitting	#321011
80	4	#8 SAE / #6 JIC Fitting	#321012
81	--	-----	-----
82	1	Plastic Insert	#232020
83	1	Check Valve	#321015
84	1	Hose, Suppressor, Case Drain	#421003
85	2	Hose, Suppressor, Clamp	#421004
86	2	Hose, Suppressor, Motor Feed	#421032
87	2	Hose, Clamp Line	#412005
88	2	Hose, Pigtail, Motor Feed	#421007
89	1	Hose, Pigtail, Case Drain	#421003
90	2	Hose, Pigtail, Clamp Line	#421004

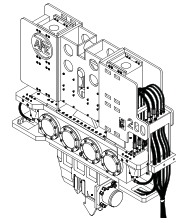




# OPERATION / MAINTENANCE MANUAL

MODEL 200, 200T & 200-6 VIBRATORY DRIVER WITH MODEL 630 POWER UNIT

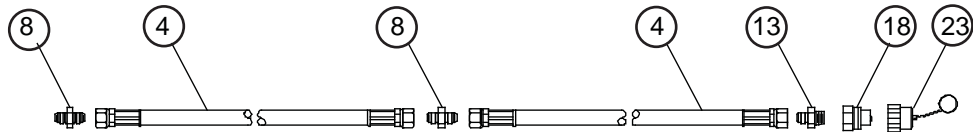
7032 SOUTH 196th - KENT, WA 98032 - (253) 872-0141 / FAX (253) 872-8710



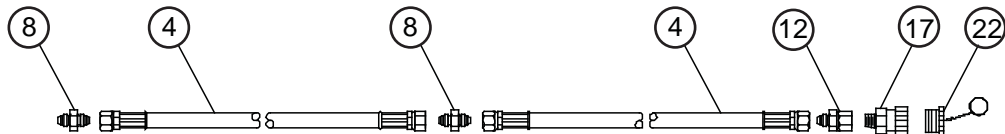
## II. COMPONENT DEFINITION (Continued...)

### II-2. Vibro Hose Bundle Identification.

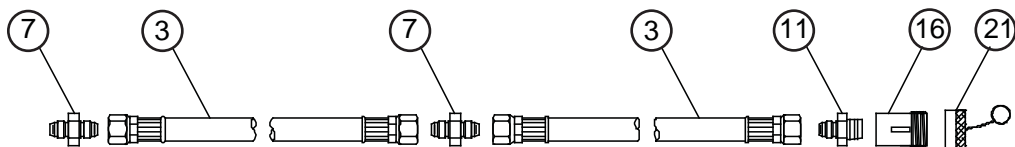
**Figure 2-B. Vibro Hose Bundle Identification.**



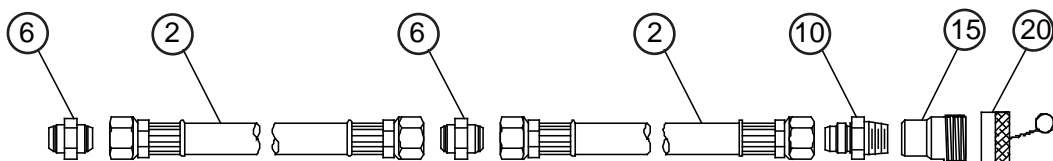
**CLAMP-CLOSE HOSE ASSEMBLY (3/8" I.D.)**



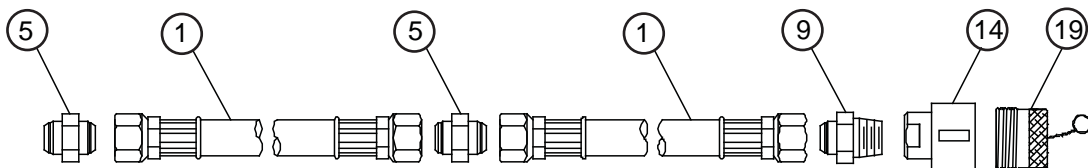
**CLAMP-OPEN HOSE ASSEMBLY (3/8" I.D.)**



**CASE DRAIN HOSE ASSEMBLY (1" I.D.)**



**PRESSURE HOSE ASSEMBLY (1-1/2" I.D.)**



**RETURN HOSE ASSEMBLY (2" I.D.)**

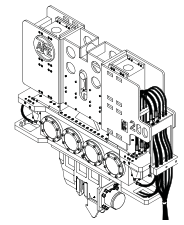




# OPERATION / MAINTENANCE MANUAL

MODEL 200, 200T & 200-6 VIBRATORY DRIVER WITH MODEL 630 POWER UNIT

7032 SOUTH 196th - KENT, WA 98032 - (253) 872-0141 / FAX (253) 872-8710



## II. COMPONENT DEFINITION (Continued...)

### II-2. Vibro Hose Bundle Identification. (Continued...)

The following is a general listing of the standard hoses that are shipped with the Model 200, 200T & 200-6 Vibratory Driver. (Please see Figure 2-B. for component location.)

**Table 2-B. Vibro Hose Bundle Identification.**

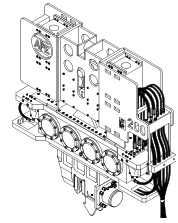
Item	Qty	Description	Part No.
1	3	2" x 50' c/w 2" FJIC e/e (5000 psi rated)	#421008
2	3	1-1/2" x 50' c/w 1-1/2" FJIC e/e (5000 psi rated)	#421008
3	3	1" x 50' c/w 1" FJIC e/e (2000 psi rated)	#421009
4	6	3/8" x 50' c/w 3/8" FJIC e/e (CPB 5500 psi)	#421010
5	3	Fitting #32 Male JIC Union	#421048
6	3	Fitting #24 Male JIC Union	#421012
7	3	Fitting #16 Male JIC Union	#421013
8	6	Fitting #6 Male JIC Union	#421014
9	1	Fitting #32 MJIC/#32 M.Pipe	#421049
10	1	Fitting #24 MJIC/#24 M.Pipe	#421015
11	1	Fitting #16 MJIC/#12 M. Pipe	#421016
12	1	Fitting #6 MJIC/#6 F. Pipe	#421011
13	1	Fitting #6 MJIC/#6 M. Pipe	#421017
14	1	2" QD Female Coupling	#441301
15	1	1-1/2" QD. Male Coupling	#400303
16	1	Aeroquip Male QD #5100S112B	#421020
17	1	Safeway Female QD #S35-3	#421024
18	1	Safeway Male QD #S31-3	#421025
19	1	APE 2" Dust Plug	#441103
20	1	APE 1-1/2" Dust Cap	#400703
21	1	Aeroquip Dust Cap #5100S712B	#421021
22	1	Safeway Plug #S34-3	#421027
23	1	Safeway Cap #S39-3	#421026



# OPERATION / MAINTENANCE MANUAL

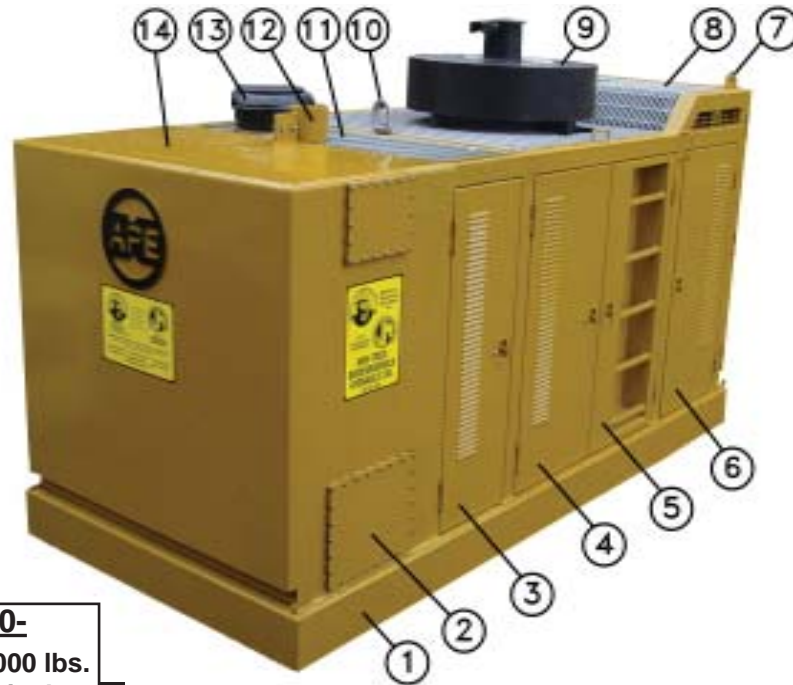
MODEL 200, 200T & 200-6 VIBRATORY DRIVER WITH MODEL 630 POWER UNIT

7032 SOUTH 196th - KENT, WA 98032 - (253) 872-0141 / FAX (253) 872-8710

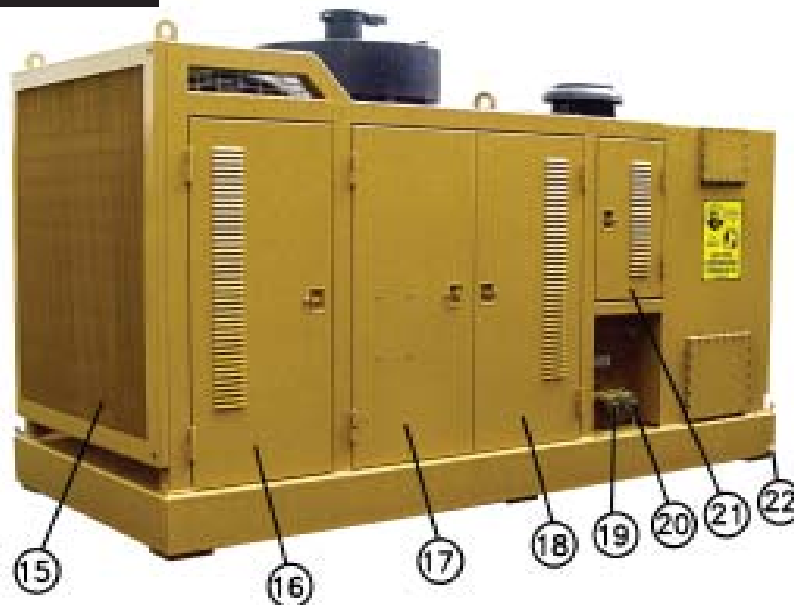


## II. COMPONENT DEFINITION (Continued...)

### II-3. Model 630 Power Unit Skid Identification.



<b>-MODEL 630-</b>	
<b>WEIGHT:</b>	20,000 lbs.
<b>LENGTH:</b>	156 inches
<b>WIDTH:</b>	72 inches
<b>HEIGHT:</b>	84 inches



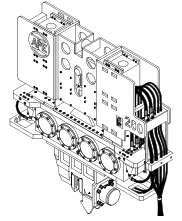
**Figure 2-C. Model 630 Power Unit Skid Identification.**



# OPERATION / MAINTENANCE MANUAL

MODEL 200, 200T & 200-6 VIBRATORY DRIVER WITH MODEL 630 POWER UNIT

7032 SOUTH 196th - KENT, WA 98032 - (253) 872-0141 / FAX (253) 872-8710



Item	Qty	Description
1	1	Fuel Tank
2	2	Hyd. Tank Access Hatch - Lower
3	1	Door A - 19.50 x 61.50
4	1	Door F - 27.63 x 61.50
5	1	Door C - 27.63 x 61.50 w/ Ladder
6	1	Door D - 27.50 x 61.50
7	2	Lifting Eye - Front
8	1	Grating - Front
9	1	Exhaust Assembly
10	1	Lifting Eye - Center
11	1	Grating - Rear
12	1	Breather Guard
13	1	Air Intake Assembly
14	1	Hydraulic Tank
15	1	Radiator Guard Door (Grated)
16	1	Door B - 27.50 x 61.50
17	1	Door E - 27.63 x 61.50
18	1	Door G - 27.63 x 61.50
19	1	Drive Supply Coupler 1.5"
20	1	Drive Return Coupler 1.5"
21	1	Door H - 19.50 x 33.50
22	1	Drain Plug

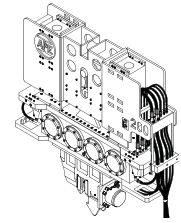
**Table 2-C. Model Power Unit Skid Identification**



# OPERATION / MAINTENANCE MANUAL

MODEL 200, 200T & 200-6 VIBRATORY DRIVER WITH MODEL 630 POWER UNIT

7032 SOUTH 196th - KENT, WA 98032 - (253) 872-0141 / FAX (253) 872-8710



## II. COMPONENT DEFINITION (Continued...)

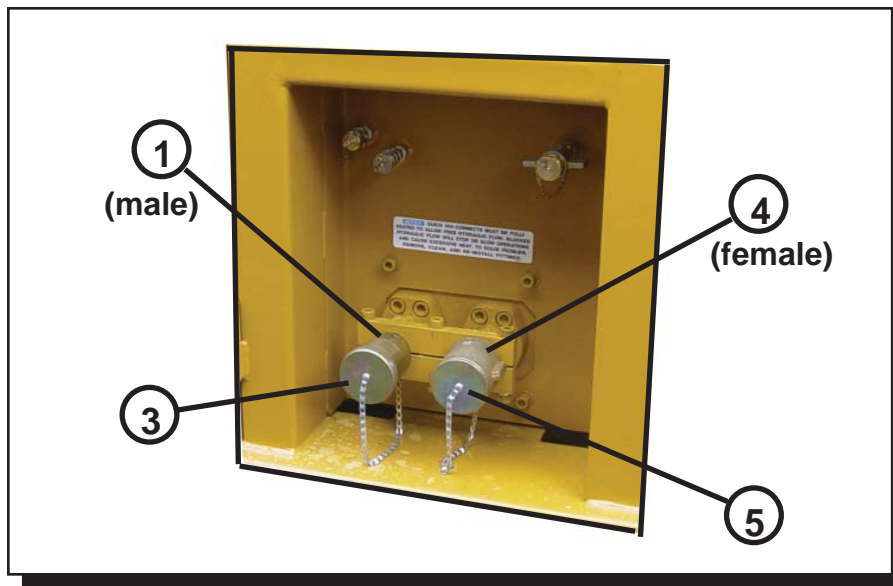
### II-4. Quick Disconnect Couplings.

The APE Quick Disconnect Couplings are high pressure hydraulic couplings designed for rugged applications. Service in many such applications has proven the design compatible to extreme pressures, structural and system induced shock loads. The construction of the coupling assembly promotes ease of use and maintenance.

#### Design Features:

- Excellent flow characteristics for continuous duty applications.
- High strength design endures high surge and shock conditions.
- Flat crested stub-ACME threads and all steel construction withstand storage and rig-up damage.
- Structurally compatible with weight of 5,000 P.S.I. flex-hose and system induced shock loads.

**Figure 2-D. Q.D. Coupling Identification at Valve Panel**



**Table 2-D. Quick Disconnect Coupling Identification.**

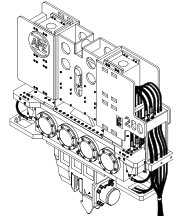
Item	Qty	Description	
1	1	1-1/2" Q.D. Set (male & female)	#400100
2	1	1-1/2" Dust Plug	#400704A
3	1	1-1/2" Dust Cap	#400703A
4	1	2" Q.D. Set (male & female)	#441100
5	1	2" Dust Plug	#441022
6	1	2" Dust Cap	#441021
		Re-build kits	
		1-1/2" Valve Parts Kit	#400103
		1-1/2" Seal Kit	#400102
		2" Valve Parts Kit	#441706
		2" Seal Kit	#441705



# OPERATION / MAINTENANCE MANUAL

MODEL 200, 200T & 200-6 VIBRATORY DRIVER WITH MODEL 630 POWER UNIT

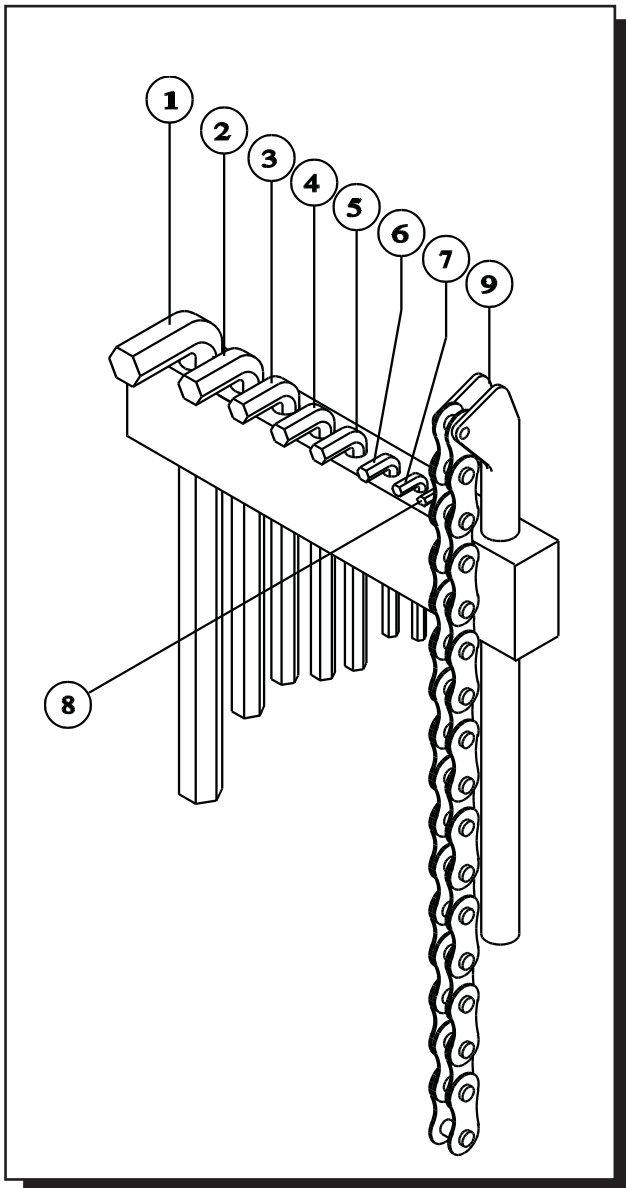
7032 SOUTH 196th - KENT, WA 98032 - (253) 872-0141 / FAX (253) 872-8710



## II. COMPONENT DEFINITION (Continued...)

### II-5. Tool Set Identification.

Mounted inside the **Model 630 Power Unit** is a set of tools frequently used for the maintenance of the **APE Model 200, 200T & 200-6 Vibratory Driver**. The following figure and table shows the location and the use for each tool.



**Table 2-E. Tool Set Identification.**

ITEM	QTY	DESCRIPTION	PART#
1	1	1" Allen Wrench	#50004
For use with the clamp attachment bolts			
2	1	3/4" Allen Wrench	#50006
For use with clamp fixed jaw, sheet guide			
3	1	5/8" Allen Wrench	#95007
For hydraulic motor, drain plug, top plate			
4	1	9/16" Allen Wrench	#50013
For use with the hose bracket bolts			
5	1	1/2" Allen Wrench	#50008
6	1	3/8" Allen Wrench	#50009
For use with bearing cover bolts			
7	1	5/16" Allen Wrench	#50014
For use with the hose bracket bolts			
8	1	1/4" Allen Wrench	#50015
For use with the vibro oil level check			
9	1	Chain Wrench	#50011
Used to tighten the quick disconnects			

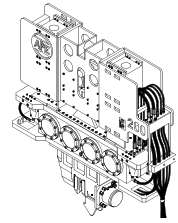
**Figure 2-E. Tool Set Identification.**



# OPERATION / MAINTENANCE MANUAL

MODEL 200, 200T & 200-6 VIBRATORY DRIVER WITH MODEL 630 POWER UNIT

7032 SOUTH 196th - KENT, WA 98032 - (253) 872-0141 / FAX (253) 872-8710



## II. COMPONENT DEFINITION (Continued...)

### II-6. Caisson Clamp Identification.

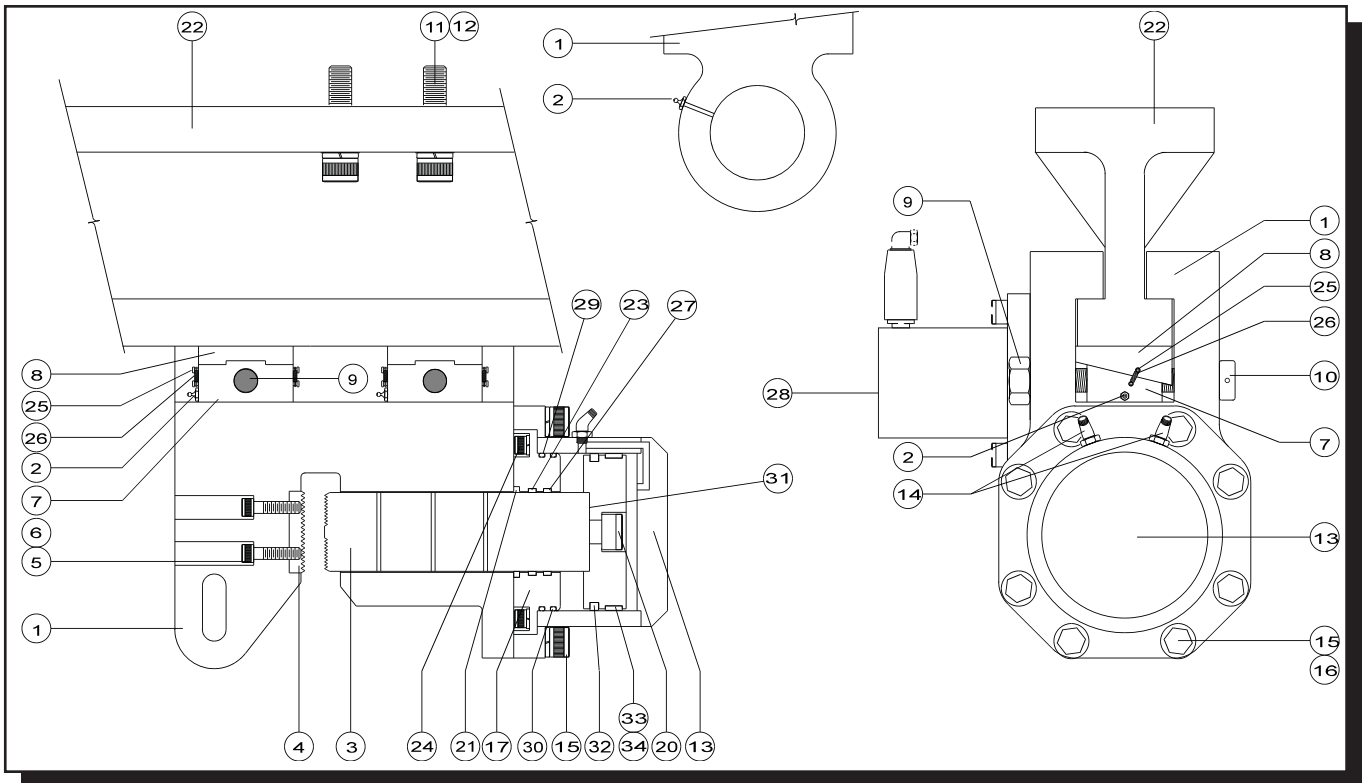
The following is a general listing of the parts for the APE Caisson Clamp and Beams. (Please see Figure 2-F. for component location.)

**Table 2-F. Caisson Clamp Identification**

Item	Qty	Description	Part #
1	1	Caisson Clamp Body	#250101
2	6	Grease Zert	#221001
3	1	Caisson Clamp Plunger/Jaw	#250301
4	1	Caisson Clamp Fixed Jaw	#250202
5	2	Bolt - SHCS 5/8" x 4"	#124214
6	2	Lock Washer 5/8" High Collar	#124115
7	2	Male Wedge Half	#243102
8	2	Female Wedge Half	#243105
9	2	Wedge Bolt w/Washer	#124211
10	2	Wedge Nut w/Washer	#124212
11	17	Bolt - SHCS 1 1/2" x 3 1/2"	#124201
12	17	Lock Wa. - 1 1/2" High Collar	#124202
13	1	Clamp Cylinder	#250001
14	2	#6 SAE/#6 JIC 45 Deg. Fitting	#222002
15	8	Bolt - SHCS 1 1/4"NFx3 1/2"GR.8	#124204
16	8	Lock Wa. - 1 1/4"High Collar	#124205
17	1	Cylinder End Cap	#250302

Item	Qty	Description	Part #
18	1	Cylinder Piston	#250303
19	1	Plunger	#250301
20	1	Bolt -SHCS 1 1/2-8 x 3"	#250304
21	1	Wiper - #959-41	#
22	1	Caisson Beam 11ft.	#903000
23	1	Poly Seal - #2500-4500-375B	#
24	12	Bolt - SHCS 5/8-18 x 1"	#
25	8	Spring Pin	#250103
26	4	Wedge Spring	#250104
27	1	Wear Ring - #W2-4750-750	#
28	1	Hydraulic Wedge Activator Kit	#243100
29	1	Parker O-Ring #8-367	#
30	1	Parker O-Ring #2-367	#
31	1	Piston O-Ring #2-338	#
32	1	Piston Wear Ring #W2-8000-750	#
33	1	TFER8000 Bronze w/Loader Ring	#
34	1	Square Ring - #4426	#

**Figure 2-F. Caisson Clamp Identification.**

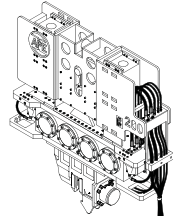




# OPERATION / MAINTENANCE MANUAL

MODEL 200, 200T & 200-6 VIBRATORY DRIVER WITH MODEL 630 POWER UNIT

7032 SOUTH 196th - KENT, WA 98032 - (253) 872-0141 / FAX (253) 872-8710



## II. COMPONENT DEFINITION (Continued...)

### II-7. Control Panel and Parts.

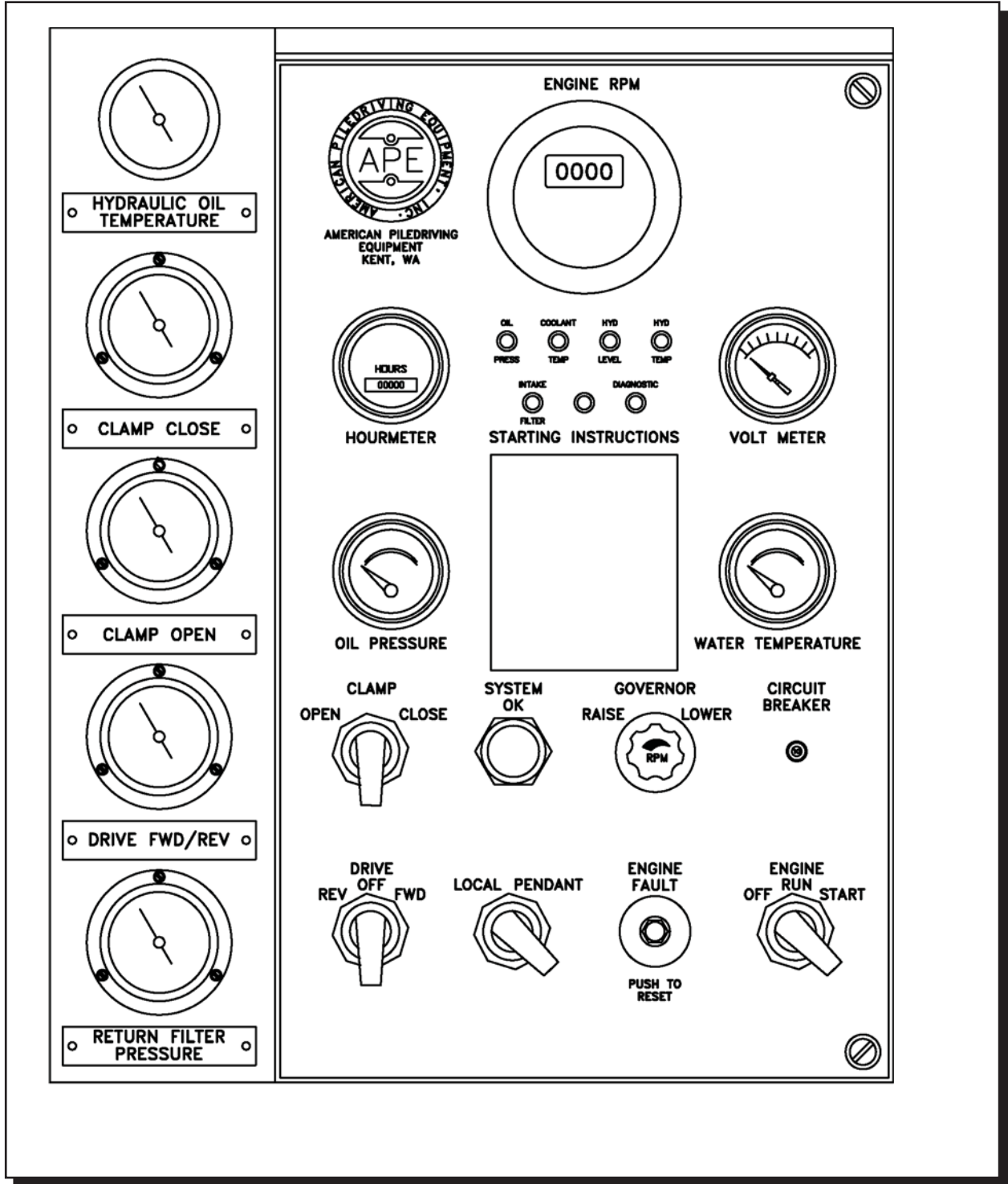


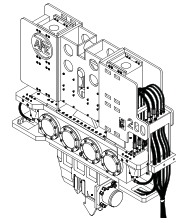
Figure 2-G1. Control Panel Front View.



# OPERATION / MAINTENANCE MANUAL

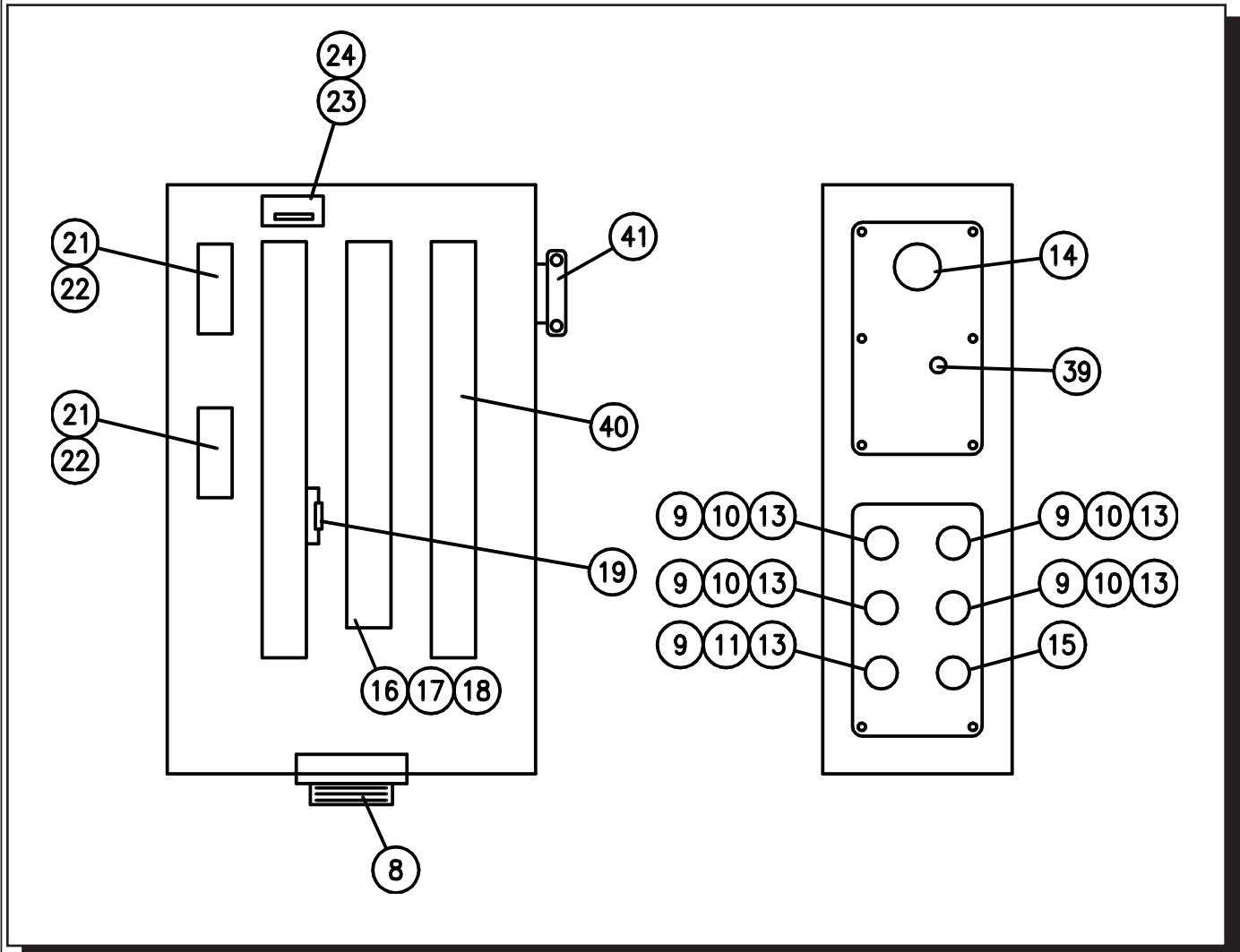
MODEL 200, 200T & 200-6 VIBRATORY DRIVER WITH MODEL 630 POWER UNIT

7032 SOUTH 196th - KENT, WA 98032 - (253) 872-0141 / FAX (253) 872-8710



## II. COMPONENT DEFINITION (Continued...)

### II-7. Control Panel and Parts. (Continued...)



**Figure 2-G2. Control Panel Internal View.**

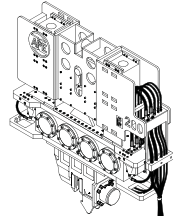




# OPERATION / MAINTENANCE MANUAL

MODEL 200, 200T & 200-6 VIBRATORY DRIVER WITH MODEL 630 POWER UNIT

7032 SOUTH 196th - KENT, WA 98032 - (253) 872-0141 / FAX (253) 872-8710



## II. COMPONENT DEFINITION (Continued...)

### II-7. Control Panel and Parts - Table 2-G.

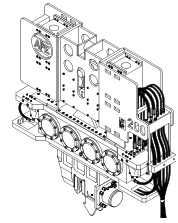
Item	Qty.	Description	Manufacturer	Manuf. Part #	APE PIN
1	1	Enclosure	Rittal	KL1537	_____
2	1	Enclosure Cover	Rittal	KL1569	_____
3	1	Cover Hinge	Rittal	KL1592	_____
4	2	Quick Fastener	Rittal	KL1593	_____
5	1	Panel Face Legend Plate	AAA	_____	_____
6	2	Shock Mount Feet	Vibration Elimination	T22-3	_____
7	4	Shock Mount Legs	Vibration Elimination	4DB	_____
8	1	Female Rec. (12 Pin)	Amphenol	MS3102A2B-18P	_____
9	5	Male Rec. (3 Pin)	Turck (Cascade)	RSF-35-1M	_____
10	4	Fem. Yellow Cord	Turck (Cascade)	RKM35-4M	_____
11	1	Double End Yellow Cord	Turck (Cascade)	WYMRKM364M	_____
12	1	Fem. Rec. (3 Pin)	Turck (Cascade)	RXF-36-1M	_____
13	5	1/2" Cord Connector	Hubble	SHC-1023-CR	_____
14	1	1" Non Metallic Connector	Thomas & Betts	3304	_____
15	1	1/8" Bulkhead Connector	Hydraline	_____	_____
16	36	Terminal Blocks	Marathon	6H38-TSKK-C	_____
17	1	Term. Block End Sect.	Marathon	6H38-E-C	_____
18	2	Term. Block End Clips	Marathon	MC	_____
19	15	Diode	I/R	6056	_____
20	1	Diode	I/R	1N4007	_____
21	2	2 Pole Relay Base	Idec	SH2B-05	_____
22	2	2 Pole Relay	Idec	RH2BU-DC24V	_____
23	1	Hourmeter (Drive)	_____	85094-12	_____
24	1	Hourmeter Support Bkt.	_____	23944	_____
25	1	Hourmeter (Engine)	Datcon	56458-10	_____
26	1	Engine Tachometer	Dynalco	SPD108-10000	_____
27	1	Ammeter	Datcon	06354-01	_____
28	1	Oil Pressure Gage	Murphy(20P-100)	10-70-3115	_____
29	1	Water Temp Gage	Murphy(20T-250-10)	10-70-2045	_____
30	1	10 Amp Circuit Breaker	_____	W58-XC4C12A-10	_____
31	1	Engine Fault Switch	Murphy	117PH	_____
32	1	System OK Light	Cutler-Hammer	10250T206N/TC2N	_____
32a	1	Syst OK Light Bulb	General Electric	757	_____
33	1	Gov. Control Sw. Operator	Cutler-Hammer	10250T3043	_____
33a	1	Contact Block (NO + NO)	Cutler-Hammer	T2	_____
34	1	Eng. Control Sw. Operator	Cutler-Hammer	10250T3053	_____
34a	1	Contact Block (NO + NC)	Cutler-Hammer	T1	_____
35	1	Local/Pendant Sw. Oper.	Cutler-Hammer	10250T3011	_____
35a	1	Contact Block (2NO+2NC)	Cutler-Hammer	T44	_____
36	1	Drive Switch Operator	Cutler-Hammer	10250T3023	_____
36a	1	Contact Block (NO + NO)	Cutler-Hammer	T2	_____
36b	1	Contact Block (NC + NC)	Cutler-Hammer	T3	_____
37	1	Clamp Switch (Lighted)	Allen Bradley	800T24JG4KB7AX	_____
37a	1	Light Bulb	Sylvania	85	_____
38	4	L.E.D. Lights	Idec	AP8M222R	_____
39	1	Gromet	_____	_____	_____
40	1	Wireway	_____	1 1/2" x 1 1/2"	_____



# OPERATION / MAINTENANCE MANUAL

MODEL 200, 200T & 200-6 VIBRATORY DRIVER WITH MODEL 630 POWER UNIT

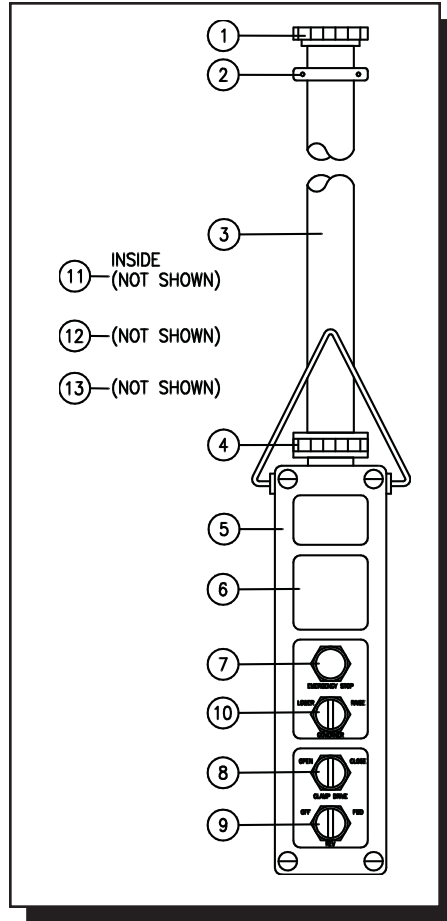
7032 SOUTH 196th - KENT, WA 98032 - (253) 872-0141 / FAX (253) 872-8710



## II. COMPONENT DEFINITION (Continued...)

### II-8. Remote Pendant and Parts.

**Figure 2-H. Remote Pendant and Parts.**



**Table 2-H. Remote Pendant and Parts.**

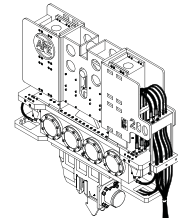
Item	Qty.	Description	Manufacturer	Manuf. Part #	APE PIN
1	1	Male Plug (12 Pin)	Amphenol	MS3106A28-18P	_____
2	1	Cable Clamp	Amphenol	MS3057-16A	_____
3	1	50 Ft Cable (16/12)	Perfect A Flex	F19061612	_____
4	1	Cord Grip		074-01-017	_____
5	1	Pendant Sw. Enclosure	Square D	9001-SKYT-4	_____
6	1	Pendant Placard	AAA		_____
7	1	Emergency Stop Button	Allen Bradley	800TA6D1	_____
8	1	Clamp Control Switch	Allen Bradley	800T24JG4IKB7AX	_____
9	1	Drive Control Switch	Allen Bradley	800TJ2KC1	_____
10	1	Governor Control Switch	Allen Bradley	800TJ91A	_____
11	3	Diode	I/R	6056	_____
12	1	Spare Rubber Connector	Amphenol	MS3420-12	_____
13	1	Spare Hole Plugs	Amphenol	9728-18P	_____



# **OPERATION / MAINTENANCE MANUAL**

MODEL 200, 200T & 200-6 VIBRATORY DRIVER WITH MODEL 630 POWER UNIT

7032 SOUTH 196th - KENT, WA 98032 - (253) 872-0141 / FAX (253) 872-8710



## **III. LOADING AND UNLOADING**

### **III-1. Model 200, 200T & 200-6 Vibratory Driver.**

The APE 200 vibrator is normally shipped in a stand on the trailer deck and the hose bundle is coiled around the inside of the stand. Lift the vibrator by rigging one line to the lifting pin which will lift the vibro, stand and hose bundle as one load. Before the truck has left, carefully inspect the machine and hoses for any missing equipment or sign of damage that may have occurred during shipment or unloading.

### **III-2. Model 630 Power Unit.**

The Power Unit is always loaded with the oil cooler facing to the rear of the truck to prevent damage to the cooler and the radiator from flying objects. The Power Unit is usually held to the truck by wrapping a chain around both ends of the fuel tank base and the truck bed. After loading the Power Unit, tape the exhaust rain cap shut to prevent rain water from getting inside. If quick disconnects do not have safety cables then store them under the panel in the storage box rather than risk the possibility of the caps and plugs coming loose and falling off into traffic. Make sure all doors are fully closed. Tighten fuel cap to prevent diesel fuel from washing out the fill spout.

### **III-3. In Cases of Damage During Shipment.**

In the event of damage, notify the trucking agent at once. Note all damage on the bill of lading. Fax the information as soon as possible, any delay may make it impossible to find the responsible party.

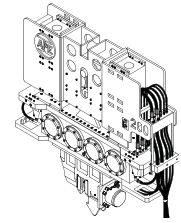
If the unit has been dropped or damaged during shipment it should not be used or repaired until an insurance adjuster inspects the equipment. Do not try to use damaged equipment. Contact APE at the phone numbers listed above. If these phone numbers are out of date then go to [www.apevibro.com](http://www.apevibro.com) for an updated phone list. Again, do not operate damaged equipment.



# **OPERATION / MAINTENANCE MANUAL**

MODEL 200, 200T & 200-6 VIBRATORY DRIVER WITH MODEL 630 POWER UNIT

7032 SOUTH 196th - KENT, WA 98032 - (253) 872-0141 / FAX (253) 872-8710



## **IV. PREPARATION AND OPERATION**

### **IV-1. Rigging of Vibratory Driver**

A steel wire rope sling must be connected to the lifting bail located on top of the vibro. The required strength of this sling depends on the capacity of the crane and the work to be carried out. A safety factor of six is recommended. Several turns of a smaller diameter cable will result in a longer lasting sling than one larger diameter cable. When making a sling, avoid using cheap cable clamps. Check the clamps daily.

### **IV-2. Installing the Clamp Attachment**

The Vibro is fitted with a standard sheet clamp at the factory. However, several types of clamps are used on APE vibros to fit many different types of piles. A step by step procedure is provided as follows:

- 1.) Clean all drilled and tapped threads on the bottom surface of the gearbox. Use a 1 1/2"UNC tap to clean any rusted threads and blow out any remaining fragments with compressed air. If there is a cutting torch on the jobsite then use the oxygen setting to blast the threads clean. Hold a rag over the tapped hole to prevent flying dirt from blasting into your eyes.
- 2.) Clean the machined bottom surface of the gearbox and prepare to mount the clamp. If the clamp bolts should ever break, check the machined surface with a straight edge to make sure it is true and flat.
- 3.) Clean the machined surface of clamp. Eye-ball the entire surface for damage. Make sure the surface is flat and void of all dirt.
- 4.) Start by getting the center bolt in first and work outwards. Do not tighten bolts until you have all of the bolts started.
- 5.) Tighten bolts using a six-foot cheater pipe. If you do not have a cheater pipe then use a sledge hammer.
- 6.) Go around all bolts at least three times making sure they are tight.
- 7.) After vibrating the first pile, check the bolts again.
- 8.) If one bolt breaks, replace them all since they may be weak or cracked.
- 9.) Never operate the vibro with missing clamp bolts.

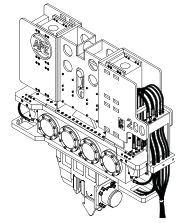
**WARNING:** Do not use grade five bolts. All bolts should be Allen head cap screw bolts. If one bolt breaks then the others are damaged and must be replaced. Never drive piles if one bolt is broken. Bolts break only because they were not tight and the crew neglected to check them. A good operator insists that every bolt is checked twice daily.



# OPERATION / MAINTENANCE MANUAL

MODEL 200, 200T & 200-6 VIBRATORY DRIVER WITH MODEL 630 POWER UNIT

7032 SOUTH 196th - KENT, WA 98032 - (253) 872-0141 / FAX (253) 872-8710



## IV. PREPARATION AND OPERATION (Continued...)

### IV-3. Plumbing the Vibro Hoses to the Power Unit.

There are five hoses leading from the vibro that must be connected to the power unit to begin operation (Please see section II-2. Hose Identification on [page 2-4] and Figure 2-B on [page 2-4]). There are two big hoses, two little hoses and one middle sized hose. The hoses attach to the power unit by screwing the quick disconnect couplers onto the proper couplers of the power unit. The couplers on the power unit are mated with the couplers on the vibro so there is no chance of putting them on backwards. Please take the following steps when installing the couplers:

**WARNING: TURN THE POWER UNIT OFF BEFORE INSTALLING COUPLERS**

- 1.) Turn the power unit OFF.
- 2.) Clean all couplers with a can of ether if available. A clean dry cloth will also work but will require extreme care. Fittings must be spotless clean.
- 3.) Install couplers by screwing them onto their respective counterparts. Try to avoid cross-threading and maintain a straight line. Jerk the hose back and forth while turning coupler to aid installation effort. **Push hard to get the big coupler threads started.**
- 4.) Make sure fittings are tight. If they are properly cleaned they should run up tight with just a firm hand grip. However, they should be double checked with a chain wrench.
- 5.) Avoid overtightening.
- 6.) If near salt water, spray with a light oil to prevent oxidation.
- 7.) Position the Power Unit so that vibrator has enough hose to reach the work. Avoid pulling too hard on hoses. Most hose failures are caused by pulling hoses off couplers.



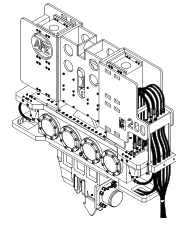
**Figure 4-A. Power Unit Coupler Layout**



# OPERATION / MAINTENANCE MANUAL

MODEL 200, 200T & 200-6 VIBRATORY DRIVER WITH MODEL 630 POWER UNIT

7032 SOUTH 196th - KENT, WA 98032 - (253) 872-0141 / FAX (253) 872-8710



## IV. PREPARATION AND OPERATION (Continued...)

### IV-4. Filling Vibrator Pressure Hose.

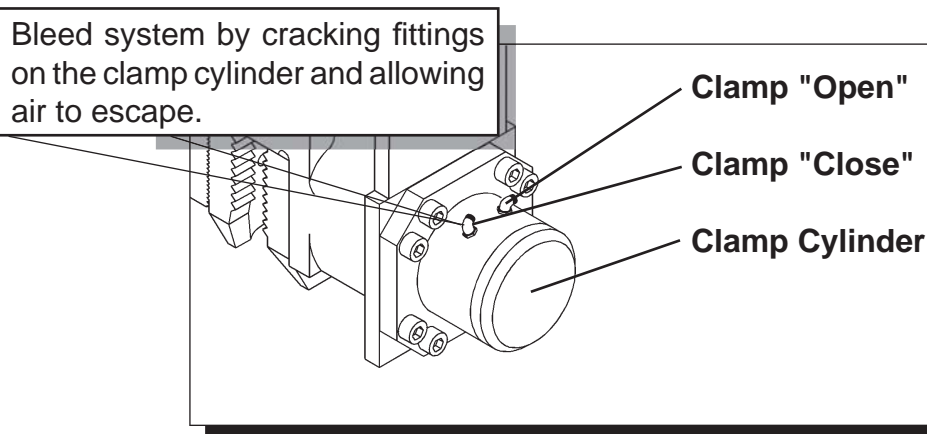
The vibrator is shipped with the hoses filled with oil. However, if the unit has been sitting for a long period of time or if a damaged hose has been replaced with a new one, then the hoses must be filled. Hook up all the hoses to the power unit (see Section IV-3 on [page 4-2] and Figure 4-A.). Start the power unit and let it run for ten minutes before running the vibro. The hoses will fill up by themselves in ten minutes even if the vibro is not in the vibrate mode.

### IV-5. Bleeding the Clamp Attachment Hydraulic Hoses.

If the opening and closing of the jaws seems spongy or slow, it may be a result of air in the clamp hoses. Normally there is no need to worry about bleeding the clamp lines because the unit is shipped fully tested. However, should the vibro sit for a long period of time, if a new attachment is being installed or if a damaged clamp hose has been replaced, then the system may require bleeding to remove unwanted air in the system. To bleed the clamp system, follow the following steps:

- 1.) Shut Power Unit OFF.
- 2.) Make sure the clamp line quick disconnects are coupled to the power unit.
- 3.) Start the power unit engine and run at 1500 rpm. Give the engine time to warm up.
- 4.) Loosen the clamp lines at the hydraulic cylinder by backing the fittings off just a little.
- 5.) Turn the clamp switch on the power unit control pendant to "CLOSE" and wait for oil to flow quickly from the fittings. WATCH FOR AIR BUBBLES. When air bubbles have stopped then quickly retighten the fittings.
- 6.) Repeat the same procedure for "OPEN" side.
- 7.) Operate the jaws. If they are still a bit spongy then repeat bleeding steps once more.

**WARNING: DO NOT BLEED SYSTEM AT FULL ENGINE THROTTLE BECAUSE TOO MUCH OIL WILL FLOW FROM THE HOSES AND COULD CAUSE INJURY.**



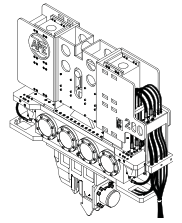
**Figure 4-B. Bleeding Clamp Attachment**



# **OPERATION / MAINTENANCE MANUAL**

MODEL 200, 200T & 200-6 VIBRATORY DRIVER WITH MODEL 630 POWER UNIT

7032 SOUTH 196th - KENT, WA 98032 - (253) 872-0141 / FAX (253) 872-8710



## **IV. PREPARATION AND OPERATION (Continued...)**

### **IV-6. Precautions and Rules for Operation.**

The following is a list of precautions, suggestions and rules that are intended to help promote the safe and productive use of the APE Model 200 Vibratory Driver.

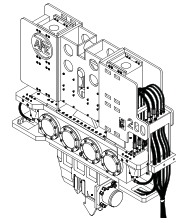
- 1.) Follow the Daily Maintenance Required Prior to Operation, [Section V-1.] [page 5-1].
- 2.) Read and follow the Safety Precautions, [page iii].
- 3.) Follow the start-up procedures listed in the manual for the power unit being used.
- 4.) Start with piles in good condition.
- 5.) Put all teeth in pile.
- 6.) Drive in steps eight feet or less.
- 7.) Keep sheets plumb.
- 8.) Come up to speed before doing work.
- 9.) No dancing. Avoid densifying the soil by vibrating too long without moving pile.
- 10.) Drive past obstacles and then go back.
- 11.) Backhoe on site to remove obstacles.
- 12.) Lead with the ball.
- 13.) Probe the pile if it appears stuck.
- 14.) Keep piles plumb or down the road you go.
- 15.) Never rush the sheet pile foreman.
- 16.) Slow and plumb and the job will get done.
- 17.) Melted inner locks - piles out of plumb.
- 18.) Never stand under pile drivers. Stay upwind to avoid dust and flying objects.
- 19.) Low clamp pressure means jaw failures.
- 20.) Wait for vibro to get to full speed then pull.
- 21.) Don't over excavate - lower the ring.
- 22.) Look at the jaws during driving.
- 23.) Beware of cracked or broken sheets.
- 24.) In sandy soils drive faster.
- 25.) In clay amplitude is everything.
- 26.) Low drive pressure means easy work.
- 27.) High pressure means friction on piles.
- 28.) Over 5000 psi means get a bigger vibro.
- 29.) No amplitude means get a bigger vibro.
- 30.) Caissons need heavy wall to avoid flex.
- 31.) Check clamp bolts each morning.
- 32.) Read the manual - know your machine.
- 33.) Attach whip line to pile when pulling.
- 34.) Know your line pull.
- 35.) Extract straight - look at boom and cable.
- 36.) Give boom stops some room.
- 37.) Stalled engine means dirty fuel filters.
- 38.) Keep fingers off machine at all times.
- 39.) Check temperature of Vibro using heat sensor. Do not exceed 200 degrees.
- 40.) Spray water on gearbox to keep cool in hard driving.
- 41.) Continue to check vibro gearbox site glass level, especially when operating underwater.



# OPERATION / MAINTENANCE MANUAL

MODEL 200, 200T & 200-6 VIBRATORY DRIVER WITH MODEL 630 POWER UNIT

7032 SOUTH 196th - KENT, WA 98032 - (253) 872-0141 / FAX (253) 872-8710

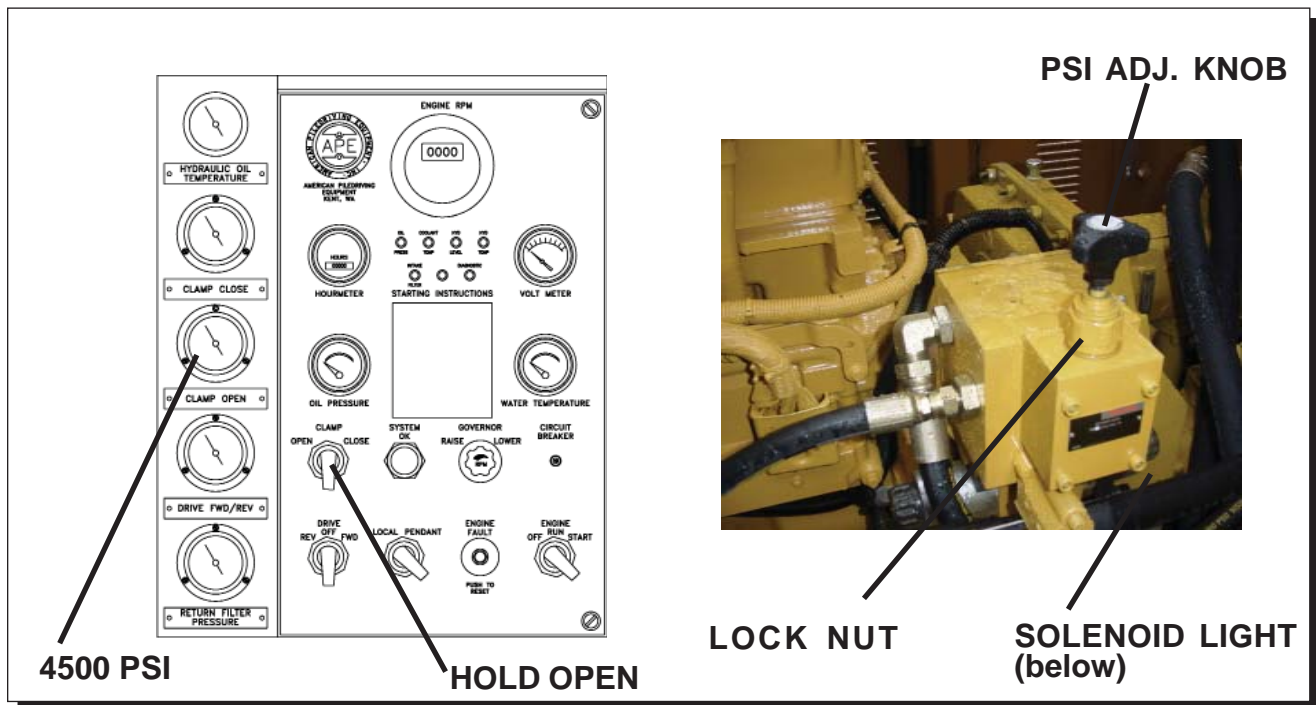


## IV. PREPARATION AND OPERATION (Continued...)

### IV-7. Model 630 Relief Valve Settings Prior to Operation

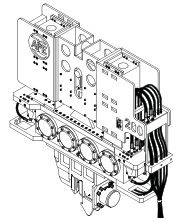
The Relief Valve and Pressure Switches are set by the factory. They will need to be re-set if the pressure switch is replaced.

1. Do not hook up quick disconnects. Start and warm engine . Bring to full rpm.
2. Check Clamp relief valve setting. On the Control Panel, turn the clamp switch to "OPEN" and hold it there while you read the CLAMP OPEN GAUGE on the panel. It should read 4500 PSI. If it is not coming up to pressure, then set the relief valve (FACTORY AUTHORIZED PERSONNEL ONLY), by loosening the lock nut and turning the knob in slowly until the proper pressure is reached. Turn in (CW) to increase pressure, and out (CCW) to decrease pressure. Lock the locknut and recheck the pressure to make sure that the setting did not move during tightening the lock nut. When the clamp switch is turned to "OPEN" and held, a small light on the solenoid is illuminated, showing that there is power to the solenoid. Otherwise, the light on the solenoid should be off.



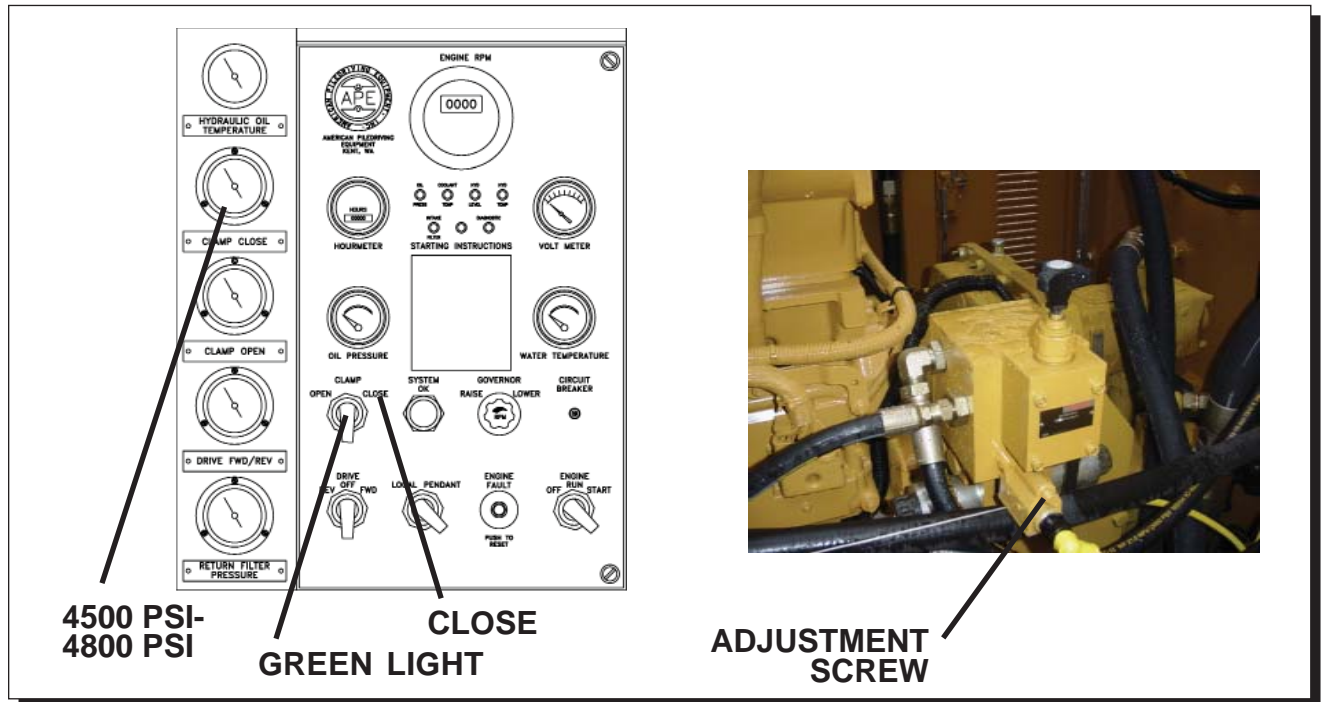
**Figure 4-C. Setting Relief Valve**





## IV. PREPARATION AND OPERATION (Continued...)

3. Check the clamp pressure switch setting. Turn the clamp to "CLOSE". If there is proper clamp pressure the CLAMP CLOSE GAUGE should read 4500 PSI to 4800 PSI, and the GREEN LIGHT comes on.



**Figure 4-D. Checking Clamp Pressure Switch Setting**

4. Adjust the clamp pressure switch setting. (If necessary). To set the pressure switch, turn the adjustment screw out using a screwdriver. (Turn it out a few turns counter-clockwise.) Turn clamp switch to "OPEN" for a second. Make sure the CLAMP OPEN GAUGE reads 4500 PSI. If it does not, then go back to the Step 2 and set the clamp relief valve first.

With clamp relief set at 4500 PSI, turn the clamp switch to "CLOSE". Green light should be on and clamp pressure should be very low or not reading at all.

Turn Adjustment Screw in (CW) until the green light goes off. Then, turn adjustment screw out (CCW) until green light comes on. (About 1/4 to 1/2 turn.) The CLAMP CLOSE GAUGE should read 4500 to 4800 PSI.

To check, turn clamp switch to "OPEN". The green light should be on.

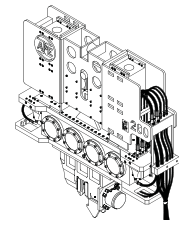
Repeat procedure if necessary.



# OPERATION / MAINTENANCE MANUAL

MODEL 200, 200T & 200-6 VIBRATORY DRIVER WITH MODEL 630 POWER UNIT

7032 SOUTH 196th - KENT, WA 98032 - (253) 872-0141 / FAX (253) 872-8710



## IV. PREPARATION AND OPERATION (Continued...)

### IV-8. Shut-down Procedures.

The following procedures explain what to do with the power unit to correctly shut down the APE Model 200 Vibratory Driver.

- 1.) Stop the vibrator. (Refer to the power unit operating manual .)
- 2.) Allow the diesel engine to run for five minutes at 1000 engine rpm.
- 3.) Reduce engine speed to low idle for about 60 seconds.
- 4.) Shut engine off by turning off the main power switch.

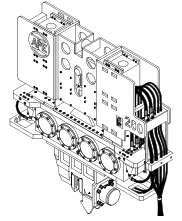
**WARNING: Do not shut the power unit engine down while the vibrator is clamped onto a pile. The clamp check valve will slowly bleed off if there is any leakage in the hose lines or worn clamp seals in the cylinder that moves the jaw open or closed.**

### IV-9. Operation of the Remote Control Pendant.

1. All functions of the vibro can be controlled by the hand held pendant. It is the choice of the crew as to where best to locate the pendant. Some prefer to give it to the crane operator so he can control all functions. Others prefer to give it to one of the ground crew so that he can position himself close to the work at hand. A 50 foot cord is provided as standard equipment. If this is not long enough, additional 50 foot sections can be added. Should the pendant become damaged, all functions can be manually operated. See Section VII-3, Page 7-10 in this manual for more details on operation. See Section VII-3A, Page 7-11 of this manual for wiring diagram.

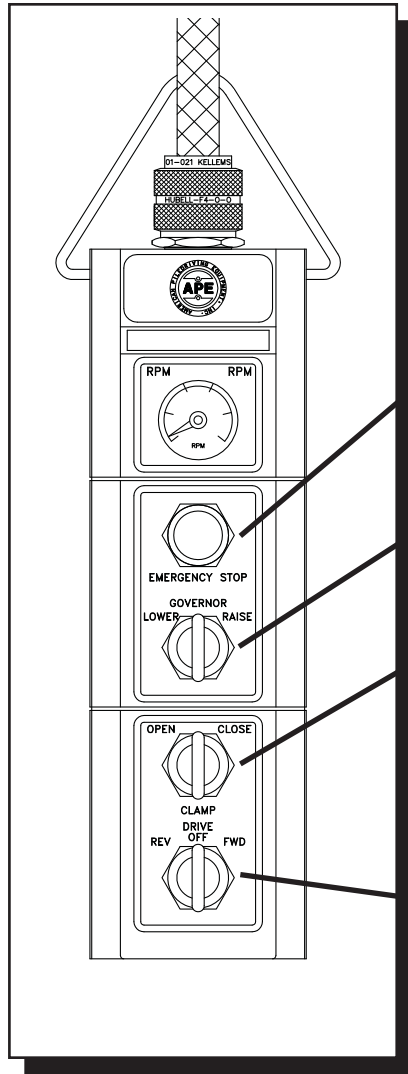
### IV-10. Normal steps to operate vibrator:

1. Position vibro on pile.
2. Turn clamp switch to Close and wait for light to come on pendant.
3. Turn to Forward to begin vibrating pile.
4. To drive, lower crane line as vibro vibrates pile.
5. To extract, pull up on vibro while vibrating.
6. See "Precautions and Rules for Operation" in this manual for more detailed operations on driving and extracting piles.
7. To stop the vibro turn the Forward switch to off.
8. To release clamp, turn clamp switch to open and hold for a second.



## IV. PREPARATION AND OPERATION (Continued...)

**Figure 4-C. Remote Control Pendant Preview.**



**Note:** The Remote Control Pendant and its operation is covered more fully in Section VII-6 on page 7-23.

**ENGINE EMERGENCY SHUTDOWN SWITCH**

Press and hold to shut engine off. Do not use to shut engine off at the end of shift. Shut unit off at panel at end of shift. Button is for emergency only.

**ENGINE THROTTLE "RAISE/LOWER" RPM**

Three Position Switch. Press and hold button to raise or lower deisel engine rpm.

**CLAMP OPEN/CLAMP CLOSE**

Lighted switch. Move to close to extend jaw and clamp vibro to pile. Light comes on when clamp is closed and locked. Turn to open to retract jaw and release vibro from pile. Switch must remain in closed position to hold clamp to pile. Sometimes the light will not come on. It could be burnt out or shorted. Check clamp pressure gauge and make sure it reads at least 3800 psi before vibrating any pile. Contact APE if light is not working.

**FORWARD/OFF/REVERSE**

Three position switch. Turn to forward to operate vibro. Turn to off to stop vibro. Turn to reverse when using power unit to run a drill motor. Vibro is not supposed to vibrate in reverse. If it does then switch the two yellow cables labeled "drive" and "reverse" located on the other side of the control panel.

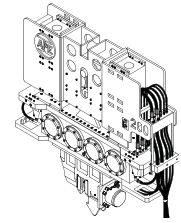
**WARNING:** Never leave vibro clamped to a pile without the crane line attached. The clamp cylinder could bleed off causing the vibro to drop. Never hoist a pile in the air without a safety line attached to the pile. Should the clamp close line become damaged and leak, the clamp cylinder could lose pressure and drop the pile.



# **OPERATION / MAINTENANCE MANUAL**

MODEL 200, 200T & 200-6 VIBRATORY DRIVER WITH MODEL 630 POWER UNIT

7032 SOUTH 196th - KENT, WA 98032 - (253) 872-0141 / FAX (253) 872-8710



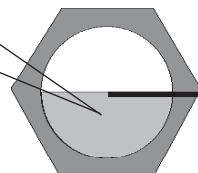
## **V. MAINTENANCE**

### **V-1. Daily Maintenance Required Prior to Operation.**

- 1.) Visually inspect the entire vibro for loose nuts or bolts. Put a wrench on the clamp bolts and check them for tightness.
- 2.) Grease the Jaw Plunger on the clamp housing.
- 3.) Check the oil level in the vibrator. Hang vibro from crane and look at sight gauge. Make sure the oil is half way up gauge. If you cannot read it then don't run the vibro. Remove the gauge and clean it by spraying a shot of starting fluid at it.

#### **YOU MUST KNOW THE LEVEL!**

**IF THE OIL LOOKS BLACK OR MILKY THEN DRAIN THE GEAR CASE AND ADD NEW HYDRAULIC OIL.**



**Oil Level  
Mobil SHC-629 + or equal.**

**Sight Gauge**

- 4.) If the oil is milky or black then change it. **Change the oil every 75 hours regardless.**
- 5.) Check the fluid level in the power unit hydraulic tank.
- 6.) Look at all the hoses. Check for cuts or other damage that might cause an oil leak.
- 7.) Check the rubbers in the suppressor housing. Look for cracks.
- 8.) Perform all start up checks as per the "start-up procedures" in the Power Unit manual.

### **V-2. Checklist After Power Unit Engine Has Started**

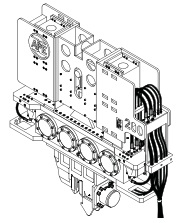
- 1.) Check all hydraulic hoses for leaks. Make sure they hang free with no kinks.
- 2.) Check inside the Power Unit. Look at all hoses and valves, check for leaks.
- 3.) Check filter indicator with engine running at full rpm. Replace if necessary.
- 4.) Check wire rope sling and make sure it is in excellent condition.
- 5.) Check jaws for wear. Replace if necessary.
- 6.) Close jaws, make sure clamp light comes on.



# **OPERATION / MAINTENANCE MANUAL**

MODEL 200, 200T & 200-6 VIBRATORY DRIVER WITH MODEL 630 POWER UNIT

7032 SOUTH 196th - KENT, WA 98032 - (253) 872-0141 / FAX (253) 872-8710



## **V. MAINTENANCE (Continued...)**

### **V-3. Maintenance and Adjustments. (75 Hours)**

Change the oil in vibrator gearbox. Remove the drain plug from bottom of gearbox and drain the oil into a bucket. Check oil for any metal shavings. Replace oil in gearbox by adding 7.0 gallons of Mobil SHC-629 gear oil or equivalent.

Clean the gearbox breathers each time the oil is changed. Replace the breathers if necessary.

### **V-4. Maintenance and Adjustments. (Eccentric Bearings)**

**1.) Model 200** - The Eccentric Bearings should be checked and/or replaced after every 2500 hours of operation.

### **V-5. Maintenance and Adjustments in Severe Conditions.**

When average temperature is above 80 F (27C) or below -1 F (-17C) reduce servicing intervals to one half of those specified above.

When operating in the presence of dust or sand, reduce servicing intervals to one-third of those specified.

During stand-by or inactive periods, the servicing intervals may be reduced to one-half. The unit should be run every 30 days or less to keep internal parts lubricated.

### **V-6A. Lubrication - Vibratory Gearbox.**

The Gearbox oil should be changed when black or milky. Mobil SHC-629 or equal is the preferred oil. Just ask your oil supplier for an equivalent type of oil. The gearbox requires 3.5 gallons of oil.

### **V-6B. Lubrication - Clamp Attachment.**

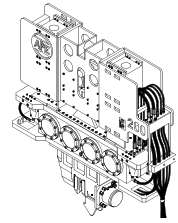
The Clamp Attachment hydraulic oil must be checked and changed on a regular basis. The Clamp Cylinder Plunger should be checked for rust and debris. Lubricate the plunger on a regular basis using the grease zert on the side of the clamp housing .



# OPERATION / MAINTENANCE MANUAL

MODEL 200, 200T & 200-6 VIBRATORY DRIVER WITH MODEL 630 POWER UNIT

7032 SOUTH 196th - KENT, WA 98032 - (253) 872-0141 / FAX (253) 872-8710



## V. MAINTENANCE (Continued...)

### V-7A. Power Unit - Filters, Fluid Types and Capacities. (Table 5-A.)

# FILTERS

<u>LOCATION</u>	<u>ENGINE</u>	<u>FILTER TYPE</u>	<u>QUANTITY</u>
Engine Oil:	CAT Engines	CAT 1 R0716	2 each
Engine Fuel:	CAT C-18	CAT 1 R0712	1 each
Air Filter:	CAT Engines	CAT 4N0015	1 each
Hydraulic Oil Filters:	-----	Pall 750OSDS8H	2 each
Hand Pump Filter:	-----	Fairey Arlon FA35-10	1 each

# ENGINE OIL TYPES AND CAPACITIES

<u>LOCATION</u>	<u>ENGINE</u>	<u>OIL TYPE</u>	<u>CAPACITY</u>
Hydraulic Oil-Main:	-----	Terresolve Envirollogic 146	533 gallon
Hyd Oil-Reserve:	-----	Terresolve Envirollogic 146	76 gallons
Engine Oil:	-----	SAE 15W40	40 quarts
Engine Water:	-----	50/50 Water/Gyicol	27 gallons
Fan Drive:	-----	Multi-Purpose Grease	
Governor Control:	-----	Multi-Purpose Grease	
Pump Drive:	-----	90W or Synthetic Model 803	

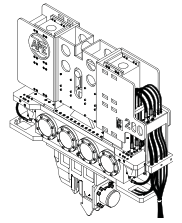
See small sight glass in center of gearbox between hydraulic motors. Oil should be filled to this level. Change every six months.



# **OPERATION / MAINTENANCE MANUAL**

MODEL 200, 200T & 200-6 VIBRATORY DRIVER WITH MODEL 630 POWER UNIT

7032 SOUTH 196th - KENT, WA 98032 - (253) 872-0141 / FAX (253) 872-8710



## **V. MAINTENANCE (Continued...)**

### **V7-B. Power Unit - Hydraulic Fluid.**

When adding or changing hydraulic fluid APE uses only Terresolve Envirollogic 146 Hydraulic Vegetable oil which is non-toxic and will not harm oil or water and is biodegradable. Consult your local oil supplier for recommendations on mixing hydraulic oils. Change hydraulic oil if it looks milky. This includes all hydraulic lines leading to and from the vibro. Milky oil indicates that water is in the oil.

### **V7-C. Power Unit - Draining and Filling Hydraulic Fluid Tank**

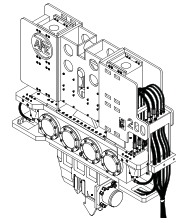
1. Remove plug located on bottom of tank
2. Refill by manually pumping with hand crank.
3. Prime both the clamp and the main pump before restarting.
4. Take extreme caution that no dirt or other unwanted particles enters the system.



# **OPERATION / MAINTENANCE MANUAL**

MODEL 200, 200T & 200-6 VIBRATORY DRIVER WITH MODEL 630 POWER UNIT

7032 SOUTH 196th - KENT, WA 98032 - (253) 872-0141 / FAX (253) 872-8710



## **V. MAINTENANCE (Continued...)**

### **V-7D. Power Unit - Changing Hydraulic Return Filter Element.**

The hydraulic return filter is mounted on the hydraulic tank inside the power unit. It is mounted high on the tank so that when the filter element is removed the oil will not drain from the hydraulic tank. The filter has a manual pop-up type indicator to toll when the filter is dirty. The pop-up indicator turns red when it is in the dirty position. Power Units 1995 and newer have a filler gauge.

### **V-7E. Power Unit - Steps to Remove the Element.**

1. Shut down power unit by turning off the diesel engine.
2. Place warning tag on control panel so that no one mistakenly starts the unit while filters are being changed.
3. Clean area around filter so that when it is removed there is no chance of introducing dirt into the hydraulic system.
4. Using a filter wrench, turn the filter counter clockwise and spin the filter off the filter housing.
5. Install new clean filter making sure the o-ring is in place.
6. Depress filter indicator to re-set to "clean position".

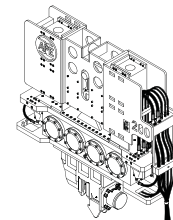




# OPERATION / MAINTENANCE MANUAL

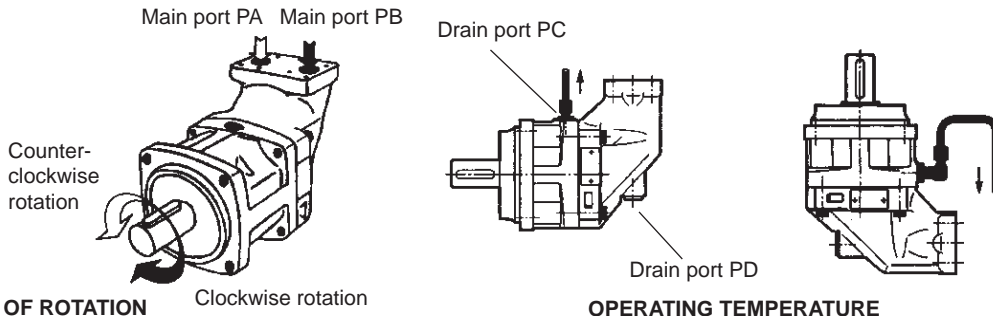
MODEL 200, 200T & 200-6 VIBRATORY DRIVER WITH MODEL 630 POWER UNIT

7032 SOUTH 196th - KENT, WA 98032 - (253) 872-0141 / FAX (253) 872-8710



## V. MAINTENANCE (Continued...)

### V-8. Hydraulic Motor - Installation and Start-Up. - Figure 5A.



#### DIRECTION OF ROTATION

The F12 motor is bi-directional. The picture shows direction of flow vs. shaft rotation. When fluid enters port **PB** (black arrow) the motor turns counter clockwise, and when port **PA** is pressurized (open arrow) the shaft turns counter clockwise.

The F12 pump rotates clockwise or counter clockwise. The ordering code shows the direction of rotation.

#### FILTRATION

To obtain maximum motor service life, the fluid cleanliness should be checked to meet ISO code 18/13 or better (ISO 4406). A10 um (absolute) filter is recommended.

#### REQUIRED INLET PRESSURE

The motor sometimes operates as a pump (e.g. when it is used in a propel transmission and the vehicle is going downhill). The motor inlet port must then be supplied with sufficient fluid pressure, or increased noise and deteriorating performance may otherwise be experienced.

#### CASE PRESSURE

The table shows the highest recommended case pressure (F12 shaft seal type **H**) as a function of shaft speed. To obtain the longest seal life, the case pressure should be limited to 50% or less of the figures shown.

**NOTE:** Contact VOAC Hydraulics for information on other shaft seals.

Motor case pressure [bar] vs. shaft speed [rpm]

designation	1500	3000	4000	5000	6000
F12-30	14.0	7.0	5.5	4.5	3.5
F12-40	12.0	6.0	4.5	3.5	
F12-60	12.0	6.0	4.5	3.5	
F12-80	10.0	5.0	4.0		
F12-110					

#### CASE DRAIN CONNECTIONS

There are two drain ports (**PC** and **PD**). The uppermost drain port should be utilized. In mounting positions such as 'shaft up', a drain line loop can be formed to provide bearing lubrication and cooling. Preferably, the drain line should be connected directly to the tank to avoid excessively high case pressure.

**NOTE:** When the motor is operating, the case must be filled with fluid to at least 50%.

#### OPERATING TEMPERATURE

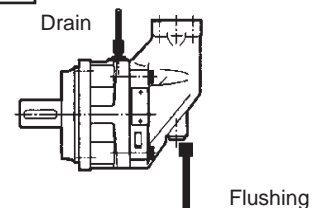
The following temperatures should not exceed (type **H** seal):

System fluid: 80deg. C  
Drain fluid: 100deg. C

Type **V** ('Viton') shaft seals can be used to 115deg. C.

Continuous operation may require case flushing in order to meet the above viscosity and temperature limitations. The table shows operating speeds, above which flushing is usually required, as well as suggested flow through the case.

Motor designation	Speed [rpm]	Flow [l/min]
F12-30	3500	4-8
F12-40	3000	5-10
F12-60	3000	7-14
F12-80	2500	8-16
F12-110	2300	9-18



#### BEFORE START-UP

Make sure the motor case as well as the entire hydraulic system is filled with a recommended fluid. The internal leakage, especially at low operating pressures, is not sufficient to provide lubrication at start-up.

#### HYDRAULIC FLUIDS

Ratings and performance data for series F12 are based on operating with good quality, contamination-free petroleum-based fluids, Hydraulic fluids type HLP (DIN 51524), automatic transmission fluids type A, or API CD engine oils can be used.

At operating temperature, the viscosity (of the drain fluid) should normally be kept above 8 mm<sup>2</sup>/s (cSt). At start-up, the viscosity should not exceed 1000 mm<sup>2</sup>/s.

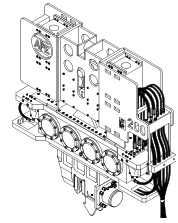
Fire resistant fluids, when used under modified operating conditions, and synthetic fluids are also suitable. Contact VOAC Hydraulics for further information.



# OPERATION / MAINTENANCE MANUAL

MODEL 200, 200T & 200-6 VIBRATORY DRIVER WITH MODEL 630 POWER UNIT

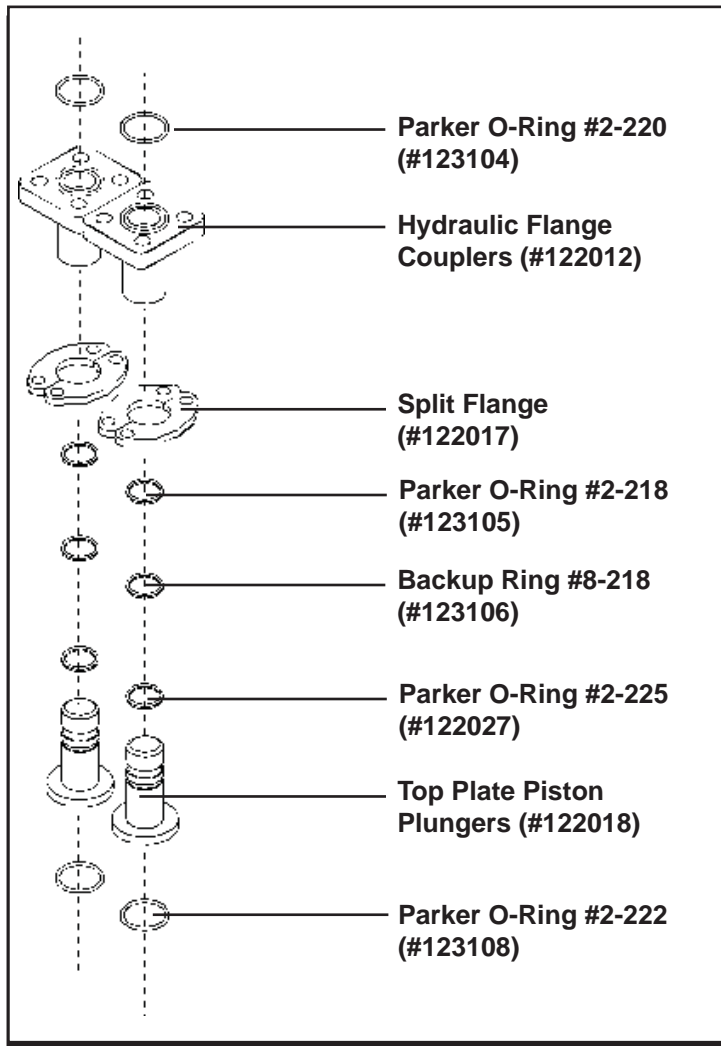
7032 SOUTH 196th - KENT, WA 98032 - (253) 872-0141 / FAX (253) 872-8710



## V. MAINTENANCE (Continued...)

### V-9. Hydraulic Motor Coupling Assembly.

The APE Hydraulic Motor Coupling Assembly allows the hydraulic fluid to flow between the rifle bored top plate of the vibro gearbox and the hydraulic motors. The following steps should be followed when removing and installing the hydraulic motors or if dis-assembly is required for maintenance of the coupling assembly:



#### Coupling Removal and Re-assembly:

1. Remove the bolts holding the "Split Flange" to top of the motor.
2. Loosen the 4 bolts which connect the "Hydraulic Flange Couplers" to the bottom of the gearbox top plate.
3. Screw the "Hydraulic Flange Couplers" and the "Top Plate Piston Plungers" together (This will decrease the overall size of the assembly and allow easier removal of the components).
4. Watch for oil flowing out from the openings on the under side of the top plate. Insert a clean rag into the openings to block the oil flow and to prevent debris from entering the opening and contaminating the hydraulic oil.
5. Reverse the procedure for re-assembly. At assembly, make sure the hydraulic motor is parallel to the top plate by verifying both sides with a tape measure. If necessary, loosen the 4 bolts holding the motor to the gearbox face and shift the motor until the top plate and motor machined face are parallel.

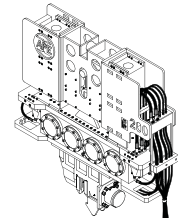
**Figure 5-B. Hydraulic Motor Coupling Assembly.**



# OPERATION / MAINTENANCE MANUAL

MODEL 200, 200T & 200-6 VIBRATORY DRIVER WITH MODEL 630 POWER UNIT

7032 SOUTH 196th - KENT, WA 98032 - (253) 872-0141 / FAX (253) 872-8710



## VI. VIBRO TROUBLE-SHOOTING

The following table lists some possible problems, causes and solutions. If a serious problem should occur, contact the factory for additional service information.

**Table 6-A. Vibro Trouble-Shooting Index**

<u>ITEM</u>	<u>PROBLEM</u>	<u>ITEM</u>	<u>PROBLEM</u>
1.	Oil Blowing Out Between Gear box and Hydraulic Motor.	6.	Vibrator Won't Start When Start Button is EnGauged.
2.	Vibro Gearbox is Too Hot.	7.	Clamp Won't Open When Clamp Open Switch is EnGauged.
3.	Excess Oil in the Gearbox.	8.	Vibro Won't Come Up to Normal Operating Speed.
4.	Oil Blowing Out From Pop-Off Valve.	9.	Vibro Won't Stop When Stop Button is EnGauged.
5.	Opening and Closing Clamp Jaws Seems Spongy or Slow.		

### Possible Cause

### Remedy

#### **1. Oil Blowing Out Between Gearbox and Hydraulic Motor.**

The breather may be plugged or damaged.

Remove the breather and clean it. If the breather is damaged replace it.

O-rings may not be sealing properly

Check the o-rings between the gearbox top plate and the motor. Clean the seal areas and replace the o-rings if needed.

#### **2. Vibro Gearbox is Too Hot.**

Oil level may be too high.

Make sure the gearbox is level. Remove the oil over fill plug (located on the gearbox next to the sight Gauge). If oil flows out, the oil level is too high and must be lowered.

Oil may be too dirty.

Look at oil in the sight Gauge. If the oil is black or milky it must be replaced. If you are still not sure, remove the case drain plug and check the oil.

#### **3. Excess Oil in the Gearbox.**

The seal between the gearbox and the hydraulic motor may be bad and is allowing oil to flow directly into the gearbox.

Remove the motor from the face of the gearbox. Check and clean the seal area, replace the seal if it looks bad.

#### **4. Oil Blowing out Pop-Off Valve.**

Blocked flow in case drain line.

Check case drain line to see if it is pinched.

Valve may be bad.

Check case drain line for proper connection tightness.

Remove and check the valve. Replace the valve if needed.

One or both motors may be damaged.

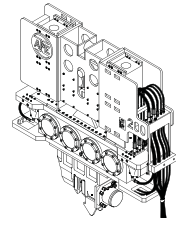
Remove the motors and have them checked for damage. Replace if needed.



# OPERATION / MAINTENANCE MANUAL

MODEL 200, 200T & 200-6 VIBRATORY DRIVER WITH MODEL 630 POWER UNIT

7032 SOUTH 196th - KENT, WA 98032 - (253) 872-0141 / FAX (253) 872-8710



## VI. VIBRO TROUBLE-SHOOTING (Continued...)

### Possible Cause

### Remedy

#### **5. Opening and Closing Clamp Jaws Seems Spongy or Slow.**

The plunger shaft may not be properly lubricated or may need cleaning.

Remove the movable jaw from the clamp. Inspect the plunger shaft and check for lubrication or debris build up. Clean the shaft if needed and then lubricate using the grease zert on the clamp body.

The clamp hoses may have air in them and may need bleeding.

Follow the procedures listed in this manual (page 4-3, Section IV-5.) for bleeding the clamp attachment hydraulic hoses.

#### **6. Vibrator Won't Start When Start Button is EnGauged.**

Diesel engine is not running.

Start diesel engine.

Start relay contacts may not be closing.

Press and hold the Start Button on the pendant. If vibro starts, replace Start Relay.

Hoses may be connected improperly.

Check hoses and make connection corrections if required.

One or both hydraulic motors may not be operating properly.

Remove one hydraulic motor from the vibro. Leave the hoses connected. Run the power unit engine at approx. 1200 rpm. and press the start button. If motor runs, re-attach it to the vibro and perform the same test with the other motor. If one of the motors does not run, it must be replaced.

Vibro gearbox may be frozen up.

If motors are working fine and the drive pressure appears normal, then the vibro gearbox may be frozen and in need of repair.

Drive pressure is too low.

Manually close start valve at the drive manifold. If vibro will not start, replace the start valve. If vibro will not start, replace the drive pump.

#### **7. Clamp Won't Open When Clamp Open Switch is EnGauged.**

Vibrator is running.

The clamp won't open while the vibro is in operation. To open the clamp, stop the vibro.

Diesel engine may not be running.

Start the power unit engine and allow clamp pressure to build.

There may be an electrical failure.

Check for the following:

- Defective clamp switch.
- Broken or loose wire in the pendant or pendant cable.
- Defective OPEN solenoid.
- Broken or loose wire between main power switch and START relay.
- Defective or sticking clamp timing delay relay.
- Broken or loose wire between main power switch and amphenol connector.

The clamp pump may be defective.

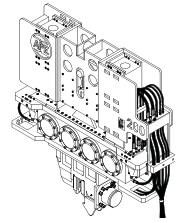
Check clamp pump for slipping belts and tighten if required. If clamp wont open, replace clamp check valves. If clamp still wont open, replace the clamp pump.



# **OPERATION / MAINTENANCE MANUAL**

MODEL 200, 200T & 200-6 VIBRATORY DRIVER WITH MODEL 630 POWER UNIT

7032 SOUTH 196th - KENT, WA 98032 - (253) 872-0141 / FAX (253) 872-8710



## **VI. VIBRO TROUBLE-SHOOTING (Continued...)**

### **Possible Cause**

### **Remedy**

#### **8. Vibro Won't Come Up to Normal Operating Speed.**

Defective hydraulic motor or drive pump.

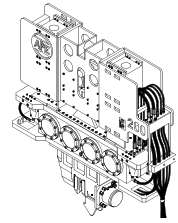
If vibration frequency has been verified lower than normal, Replace the hydraulic motors one at a time to see if performance improves. If vibro still operates below normal speed, replace drive motor pump.

#### **9. Vibro Won't Stop When Stop Button is Engaged.**

There may be an electrical failure.

Check for the following:

- Defective STOP button.
- Broken or loose wire in the pendant or pendant cable.
- Defective START relay.
- Defective motor START valve.



### VII. MODEL 630 POWER UNIT



**Figure 7-A. APE 630 Power Unit Left Side View**

#### **VII-1. Power Unit Skid**

For a general breakdown of the power unit skid, see section II-3.

#### **VII-2. Power Unit Systems - General Description**

The APE model 630 power unit provides hydraulic pressure and flow to drive APE hydraulic equipment. In its standard configuration it is equipped for vibratory hammers. It can be equipped to provide power for hydraulic impact hammers and earth augers as well.

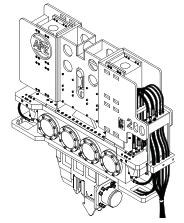
**Fuel Tank** - The fuel tank consists of the tubular steel members comprising the base of the skid. The fuel capacity is 145 gallons (550 liters), diesel fuel only. The filler cap is located on the right hand side. The fuel tank is plumbed to provide fuel flow to the engine.



# OPERATION / MAINTENANCE MANUAL

MODEL 200, 200T & 200-6 VIBRATORY DRIVER WITH MODEL 630 POWER UNIT

7032 SOUTH 196th - KENT, WA 98032 - (253) 872-0141 / FAX (253) 872-8710



## VII. MODEL 630 POWER UNIT, (Continued...)

### VII-2. Power Unit Systems - General Description, (Continued...)

**Hydraulic Tank** - The hydraulic tank is located on the rear of the unit. It consists of a Main tank (lower) and a Reserve tank (upper). The capacity of the Main tank is 533 gallons (2025 liters). The capacity of the reserve tank is 76 gallons (290 liters). The hydraulic tank is filled using a hand pump, provided on the right hand side of the power unit. There is a manually operated transfer valve (located on the tank wall) that allows the fluid from the reserve tank to be transferred to the main tank.

Sight glasses are provided to allow the fluid levels to be monitored. They are located inside the power unit skid on the right hand side, on the hydraulic tank wall. An electric float switch will shut down the engine if the fluid level falls unacceptably low.

The hydraulic tank is plumbed to send hydraulic fluid to the pumps, and then to the Hydraulic Control Manifolds, and from there to the hydraulic machinery.

**Hydraulic Pumps** - There are four hydraulic pumps (Fig. 7-C). Three of these pumps (large) are "Drive Pumps" located at the rear of the engine, providing flow to the Drive Manifold, and for hydraulic re-circulation. One of the pumps (small) is a "Clamp Pump", located at the forward left hand side of the engine, providing flow to the Clamp Manifold.

**Pump Drive** - The pump drive is located at the rear of the engine (Fig. 7-B). It couples the engine to the "Drive Pumps".

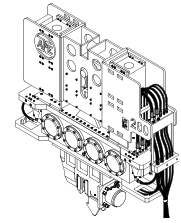
**Hydraulic Manifolds** - There are two hydraulic manifolds. The (small) Clamp Manifold (Fig. 7-C,7-K) is located on the left hand side of the power unit, near the rear of the engine. The (large) Drive Manifold (7-I) is located at the rear, left hand side of the power unit, near the coupler panel. The manifolds respond to operator commands at the control panel (or the pendant), allowing the hydraulic oil to flow to the hydraulic machinery.

**Valve Panel** - The valve panel is located on the left side of the power unit, near the rear. It contains "quick disconnect couplers" to attach the hoses to the hydraulic machinery.

**Control Panel** - The control panel (Fig. 7-D) is located on the left side of the power unit, inside a door. It allows the operator to control and monitor the engine and the hydraulic machinery.

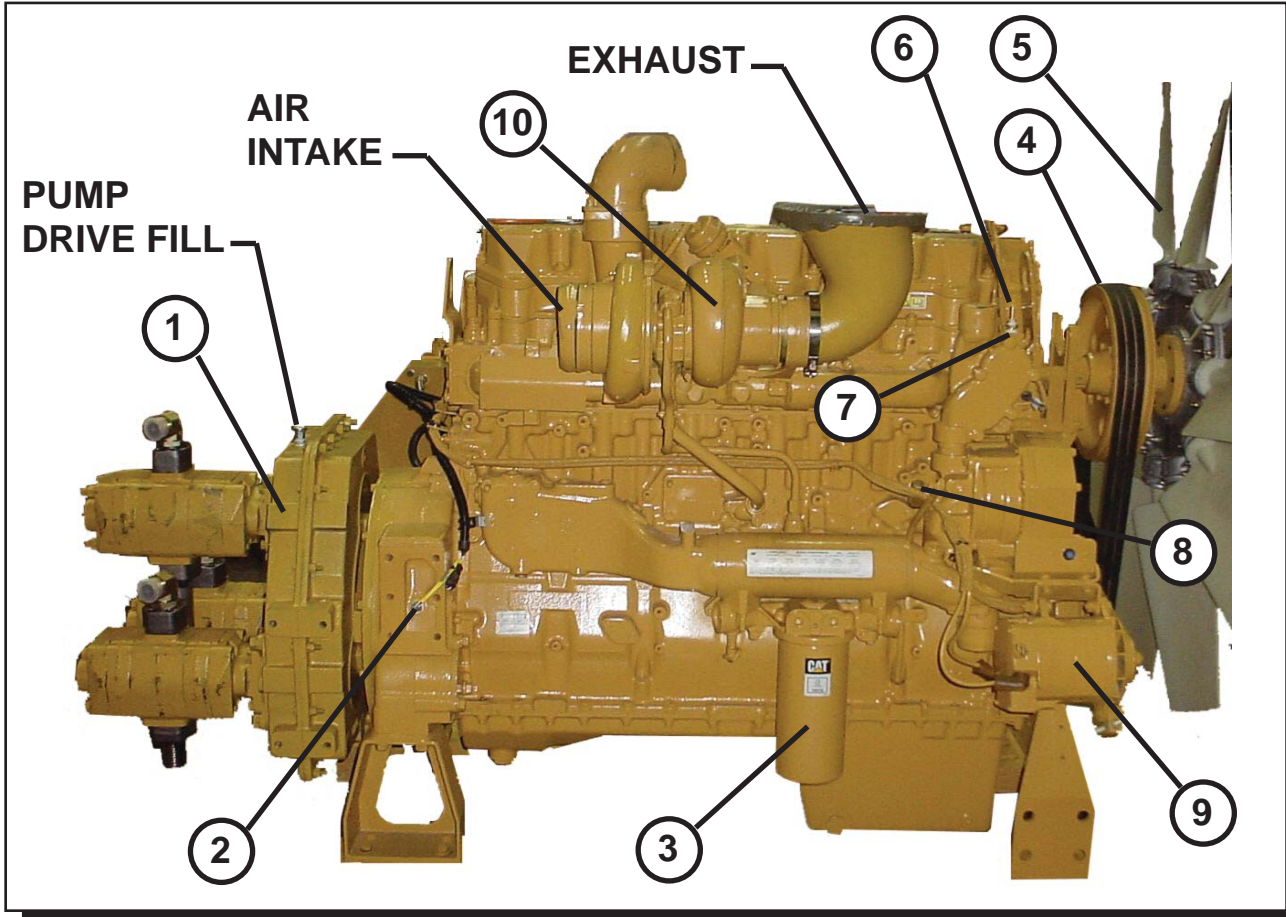
**Pendant** - The control pendant allows the operator to control the hydraulic machinery remotely, via a 50 ft (15m) power cord.

**Engine** - The engine is a 630 HP (470 kW) Caterpillar C-18 diesel engine. It provides rotational power to drive the hydraulic pumps. (See Fig. 7-B).



## VII. MODEL 630 POWER UNIT, (Continued...)

### VII-3. Engine Layout

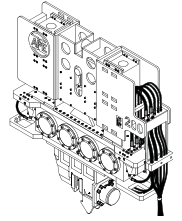


**Figure 7-B. CAT C-18 Right Side View**

ITEM	QTY	DESCRIPTION	MFG.	MFG P/N
1	1	Pump Drive	Spencer	803F
2	1	Magnetic Pickup	NC	
3	1	Oil Filter	NC	
4	3	Vee Belt	CAT	6N-C650 DF
5	1	Fan, Suction	NC	
6	1	Water Temp Gauge	ISSPRO	
7	1	Two-Piece Fitting 1/2 MP x 1/4 Hose Barb - Str. Brass	WFC	125HBL-4-4/209P8-4
8	1	Two-Piece Fitting 3/4 MP x 3/4 Hose Barb -90 deg	WFC	NPT 90 16-12
9	1	Alternator	NC	
10	1	Turbo Charger	CAT	

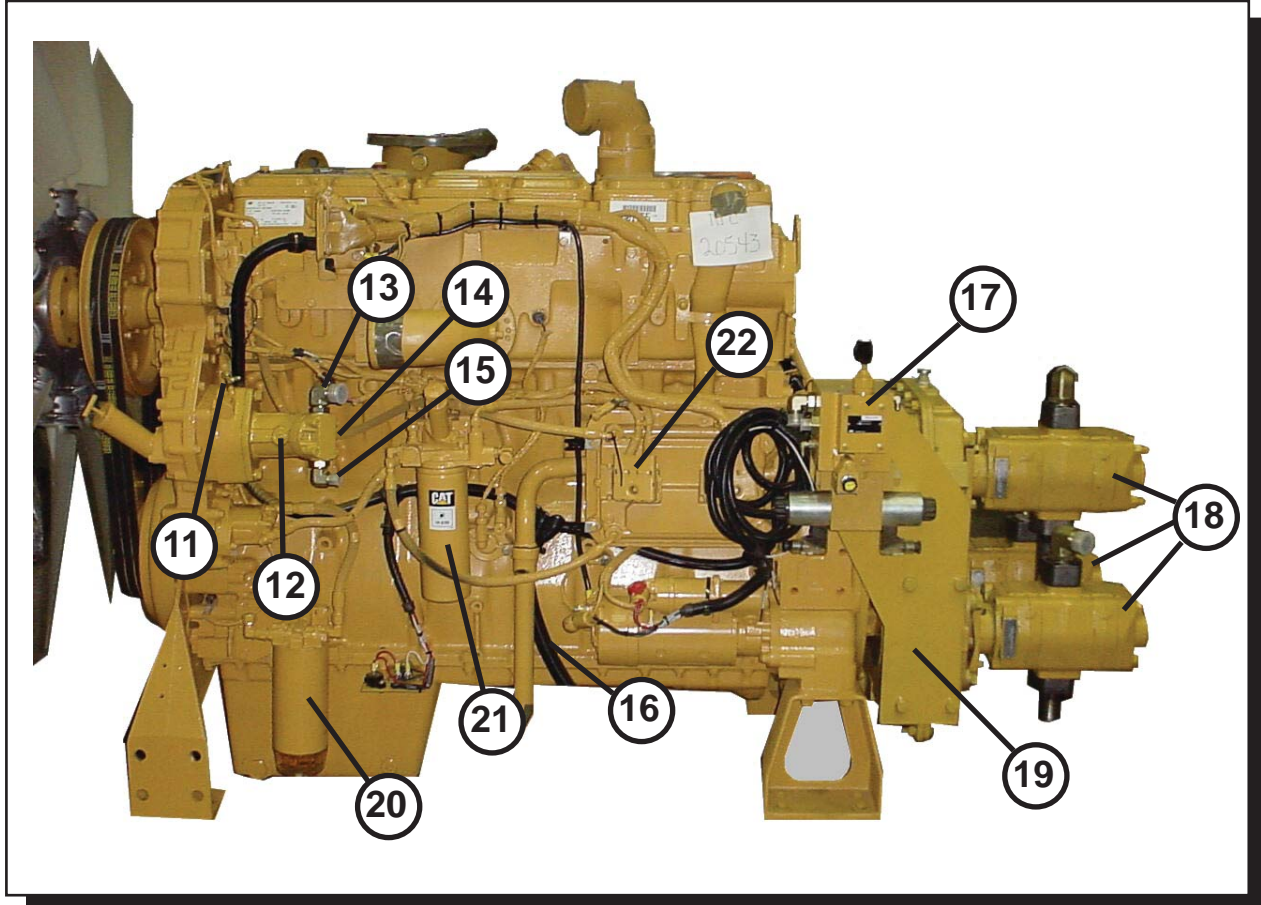
**Table 7-A. CAT C-18 Identification**





## VII. MODEL 630 POWER UNIT, (Continued...)

### VII-3. Engine Layout, Cont.



**Figure 7-C. CAT C-18 Left Side View**

ITEM	QTY	DESCRIPTION	MFG.	MFG P/N
11	1	Fitting, Run Tee, Swivel Nut	Parker	4 R6X/063T
12	1	Clamp Pump	PPT	
13	1	Fitting	Parker	16-12 C50X/2503
14	1	Fitting	Parker	6-6 C50X/2503
15	1	Fitting	Parker	8-12 C50X/2503
16	1	Wiring Harness	NC	
17	1	Clamp Manifold Assembly	PPT	
18	1	Drive Pumps	Hyd. Ind.	
19	1	Mounting Plate (for Clamp Manifold)	Pac Fab	
20	1	Water/Fuel Separator	NC	
21	1	Fuel Filter	NC	
22	1	ECM (Electronic Control Module)	NC	

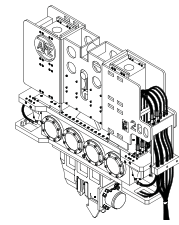
**Table 7-A. CAT C-18 Identification (Continued...)**



# OPERATION / MAINTENANCE MANUAL

MODEL 200, 200T & 200-6 VIBRATORY DRIVER WITH MODEL 630 POWER UNIT

7032 SOUTH 196th - KENT, WA 98032 - (253) 872-0141 / FAX (253) 872-8710



## VII. MODEL 630 POWER UNIT, (Continued...)

### VII-4. Hydraulic Circuitry.

The following are descriptions of the components that make up the Hydraulic Circuitry of the APE Model 630 Power Unit.

#### VII-4A. Clamp Circuitry. (Used for extending and retracting jaw cylinder)

Oil for the clamp circuit is provided by the clamp pump (item # 12, Fig. 7-C ). All oil to the inlet of this pump is filtered through a suction strainer located in the tank. Clamp oil is then directed from the pump to the clamp directional control valve (inside item #17, Fig 7-C ).

**OFF** - When the clamp switch (in the Control Panel, Fig 7-D) is in the OFF position, the oil flows through the clamp directional control valve and back to the oil tank. All hydraulic oil returning to tank is filtered with the return filter.

**RETRACT** - When the clamp switch is moved to OPEN, solenoid "A" on the clamp directional control valve is energized, and the oil will flow out to the clamp cylinder and retract (open) the jaws. The clamp open pressure can be seen on the clamp pressure Gauge (Figure 7-D).

**EXTEND** - When the clamp switch is moved to the CLOSED position, solenoid "B" will be energized and oil flow will be directed to the clamp cylinder. The clamp cylinder will then extend (close) the jaws. Clamp pressure can be seen on the clamp close gauge (Figure 7-D).

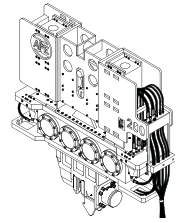
**MAINTAIN** - Clamp pressure is automatically maintained in clamp cylinder by a pilot-operated check valve. If the clamp pressure falls below 4000 psi, the clamp pressure switch will re-energize solenoid "B" on the clamp control valve, and direct pump flow to the clamp cylinder. Maximum clamp pressure is limited by the clamp pressure relief valve set at 4500 psi.



# OPERATION / MAINTENANCE MANUAL

MODEL 200, 200T & 200-6 VIBRATORY DRIVER WITH MODEL 630 POWER UNIT

7032 SOUTH 196th - KENT, WA 98032 - (253) 872-0141 / FAX (253) 872-8710



## VII. MODEL 630 POWER UNIT, (Continued...)

**VII-4B. Drive Circuitry.** (Used for operating APE vibrator, APE drill or any other unit.)

There are three pumps (item #18, Fig. 7-C) that direct oil to the drive circuit (Vibro Motors). The maximum drive pressure is controlled by setting the drive pressure relief valve to 5000 psi. max.

**FORWARD** - When the drive switch is moved to the forward position, solenoid "A" of the drive directional control valve (item #4, Fig. 7-I) is energized . Oil flow is directed to the vibro motors to rotate the eccentrics.

**OFF** - When the drive switch is moved to the off position, solenoid "A" is de-energized. Oil flow is directed back to the tank through the drive directional control valve.

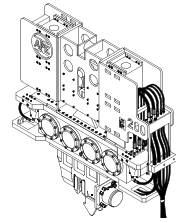
The drive pressure can be read on the drive pressure Gauge (Fig. 7-D).



# OPERATION / MAINTENANCE MANUAL

MODEL 200, 200T & 200-6 VIBRATORY DRIVER WITH MODEL 630 POWER UNIT

7032 SOUTH 196th - KENT, WA 98032 - (253) 872-0141 / FAX (253) 872-8710



## VII. MODEL 630 POWER UNIT, (Continued...)

### VII-4C. Recirculation Filter.

Hydraulic fluid is filtered by the recirculation filter.

### VII-4D. Oil Cooler.

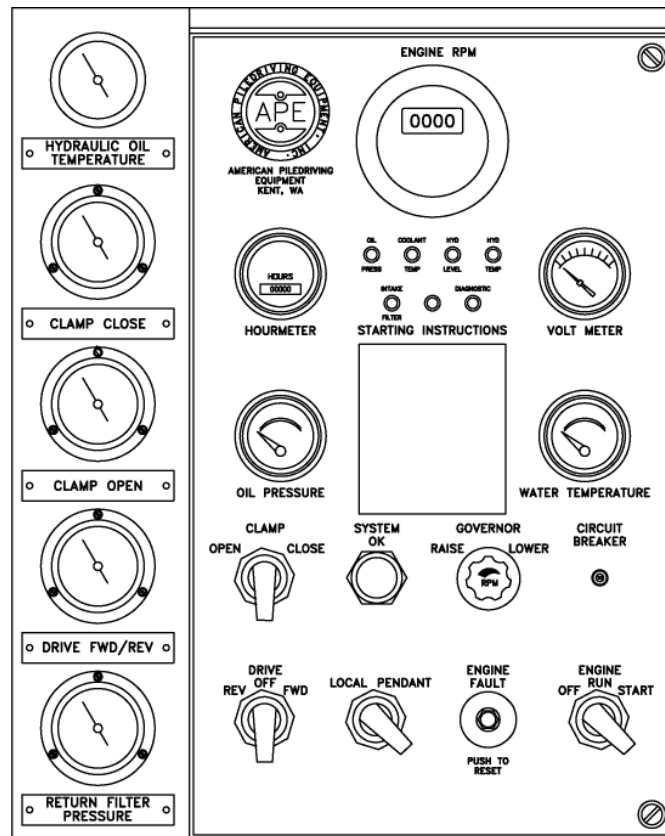
The oil cooler cools the hydraulic fluid returning from the vibrator.

### VII-4E. Manual Pump.

A manual pump, item is provided to fill the hydraulic reservoir. A hand valve prevents loss of fluid from the reservoir back through the manual pump.

### VII-4F. Hydraulic Oil Temperature.

A temperature gauge (Fig 7D) indicates hydraulic oil temperature. The sending unit is mounted on the main tank (See Tank Detail Fig 7-F.)



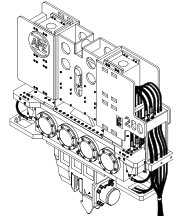
**Figure 7-D. Model 630 Control Panel**



# OPERATION / MAINTENANCE MANUAL

MODEL 200, 200T & 200-6 VIBRATORY DRIVER WITH MODEL 630 POWER UNIT

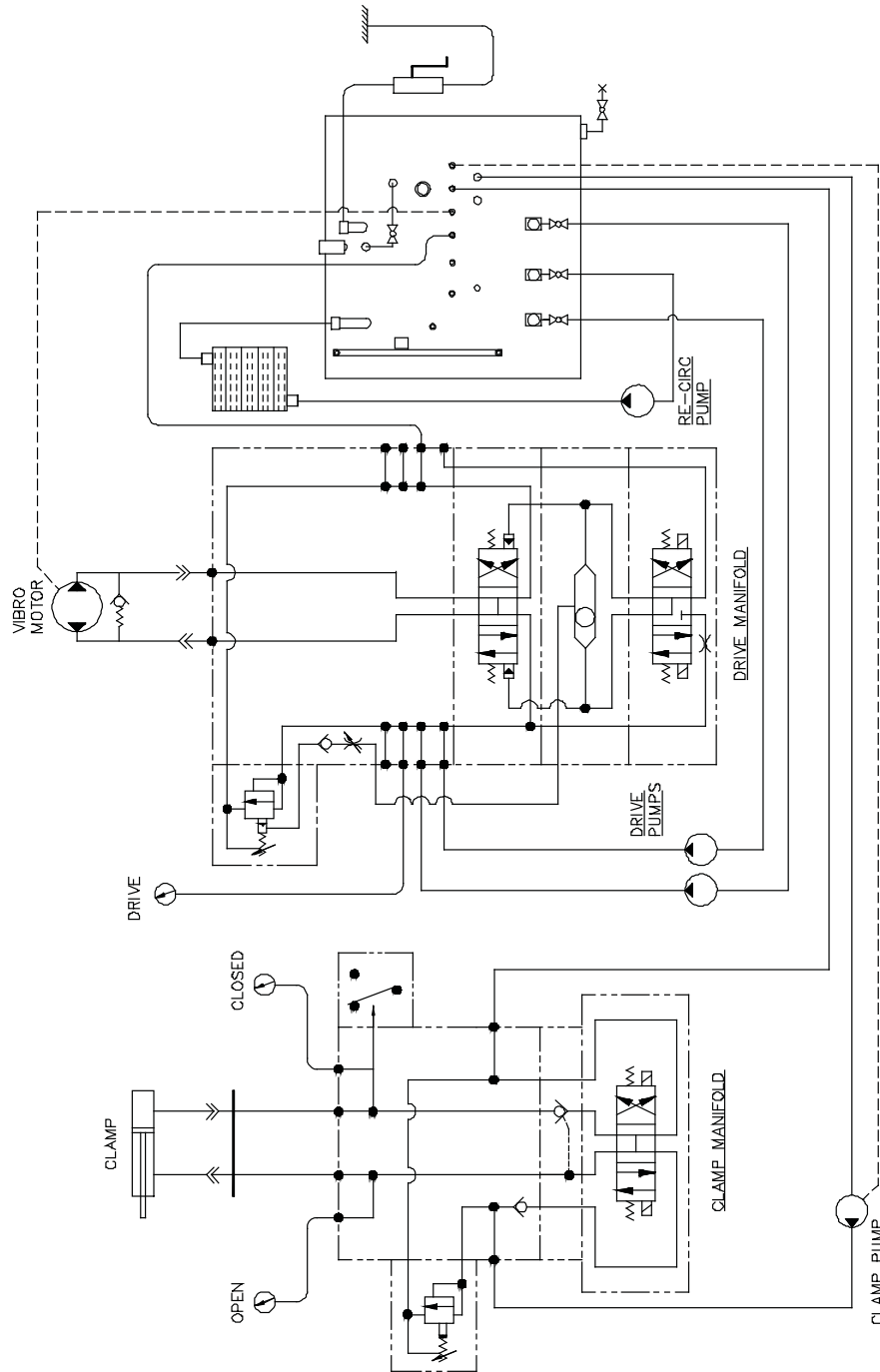
7032 SOUTH 196th - KENT, WA 98032 - (253) 872-0141 / FAX (253) 872-8710



## VII. MODEL 630 POWER UNIT, (Continued...)

### VII-5. Hydraulic Components.

#### VII-5A. Hydraulic Schematic.



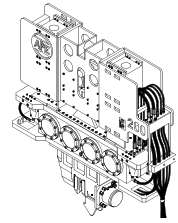
**Figure 7-E. Model 630 Hydraulic Schematic**



# OPERATION / MAINTENANCE MANUAL

MODEL 200, 200T & 200-6 VIBRATORY DRIVER WITH MODEL 630 POWER UNIT

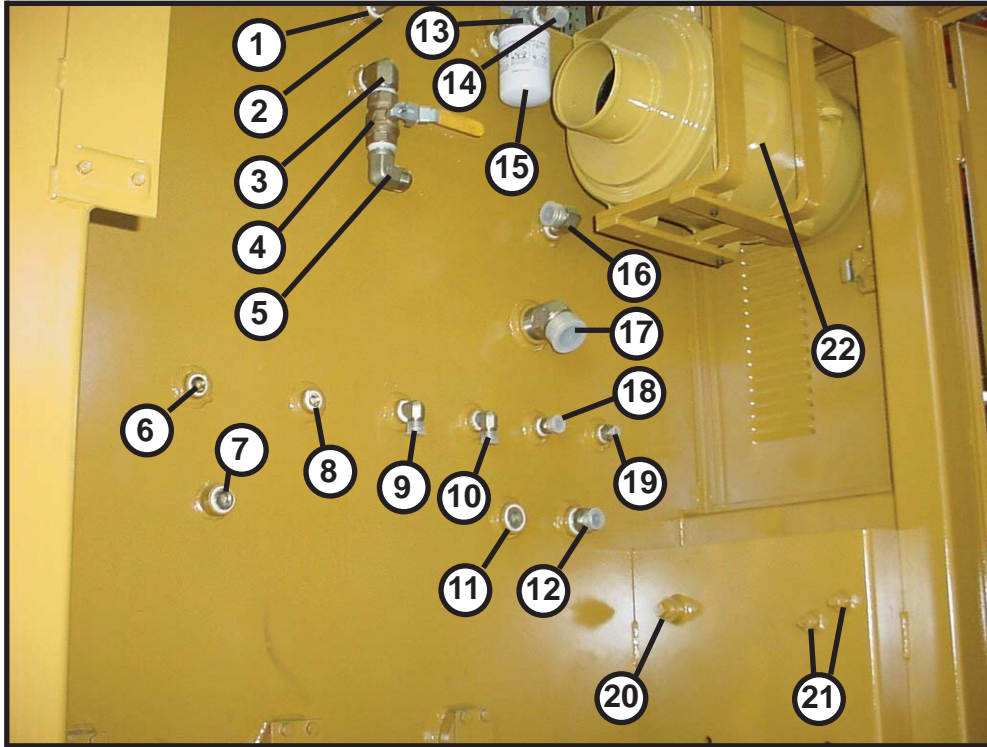
7032 SOUTH 196th - KENT, WA 98032 - (253) 872-0141 / FAX (253) 872-8710



## VII. MODEL 630 POWER UNIT (Continued...)

### VII-5. Hydraulic Components. (Continued...)

#### VII-5B. Hydraulic Tank.



**Figure 7-F. Model 630 Hydraulic Tank Fitting Callout**

ITEM	QTY	DESCRIPTION	MFG.	ID No.
1	1	Fitting	Parker	1" x 3/4" CD/2102
2	1	Fitting	Zinga	TB075
3	1	Fitting	Parker	1-1/4" CD/2102
4	1	Manual Valve	Parker	VP500P-20
5	1	Fitting	Parker	20 CTX/2103
6	1	Fitting	Parker	3/4" HHP/01HP
7	1	Fitting	Parker	1" HHP/01HP
8	1	Fitting	Parker	3/4" HHP/01HP
9	1	Fitting	Parker	12 CTX/2103
10	1	Fitting	Parker	12 CTX/2103
11	1	Fitting	Parker	1-1/4" HHP/01HP
12	1	Fitting	Parker	16 FTX/0103
13	1	Fitting	Parker	1" FF/0101
14	1	Fitting	Parker	16 VTX/3103
15	1	Filter	Zinga	2GF-10-25-1-3/GE25
16	1	Fitting	Parker	20 CTX/2103
17	1	Fitting	Parker	32 VTX/3103
18	1	Fitting	Parker	16-20 FTX/0103
19	1	Fitting	Parker	6-12 FTX/0103
20	1	Fitting	Parker	20 FTX
21	1	Fitting	Parker	8-8 CTX
22	1	Air Cleaner	Parker	163-0820

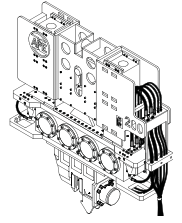
**Table 7-B . Model 630 Hydraulic Tank Fitting Callout**



# OPERATION / MAINTENANCE MANUAL

MODEL 200, 200T & 200-6 VIBRATORY DRIVER WITH MODEL 630 POWER UNIT

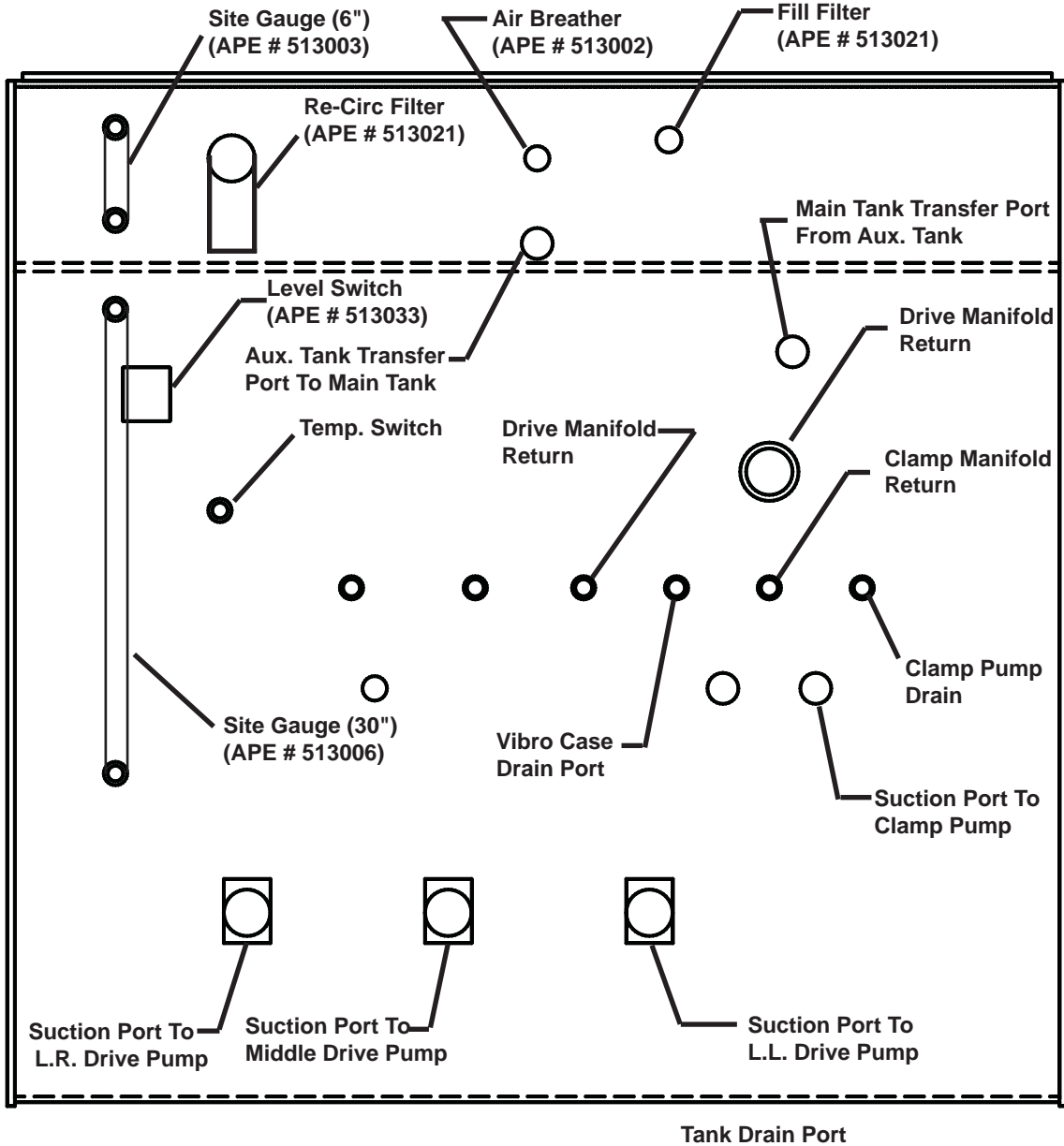
7032 SOUTH 196th - KENT, WA 98032 - (253) 872-0141 / FAX (253) 872-8710



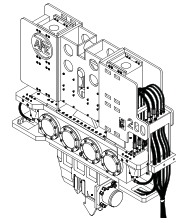
## VII. MODEL 630 POWER UNIT (Continued...)

### VII-5. Hydraulic Components. (Continued...)

#### VII-5B. Hydraulic Tank. (Continued...)



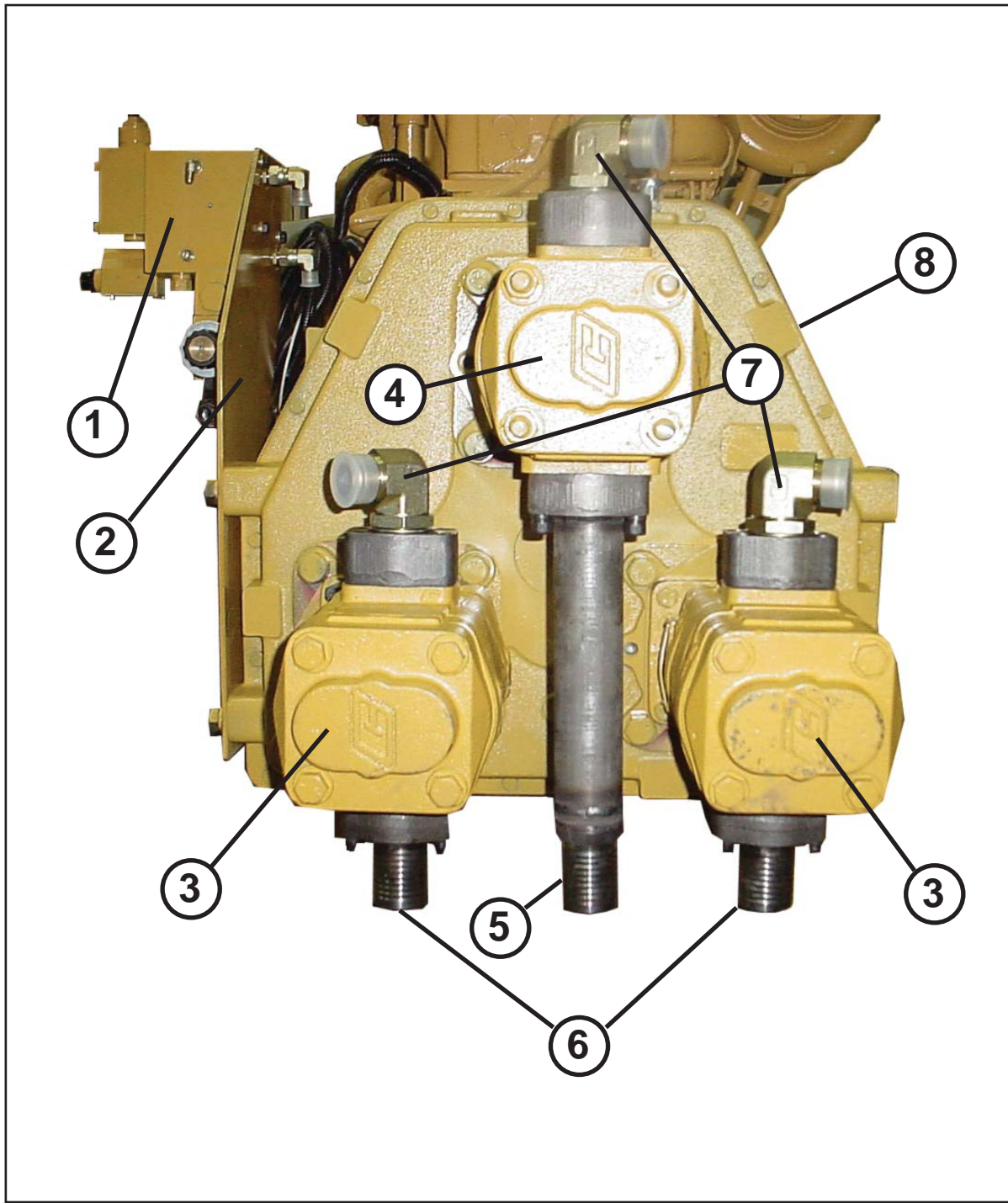
**Figure 7-G. Model 630 Tank Detail**



## VII. MODEL 630 POWER UNIT, (Continued...)

### VII-5. Hydraulic Components. (Continued...)

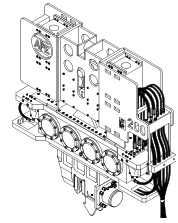
#### VII-5C. Drive Pumps.



**Figure 7-H. Rear of Engine w/ Drive Pumps**



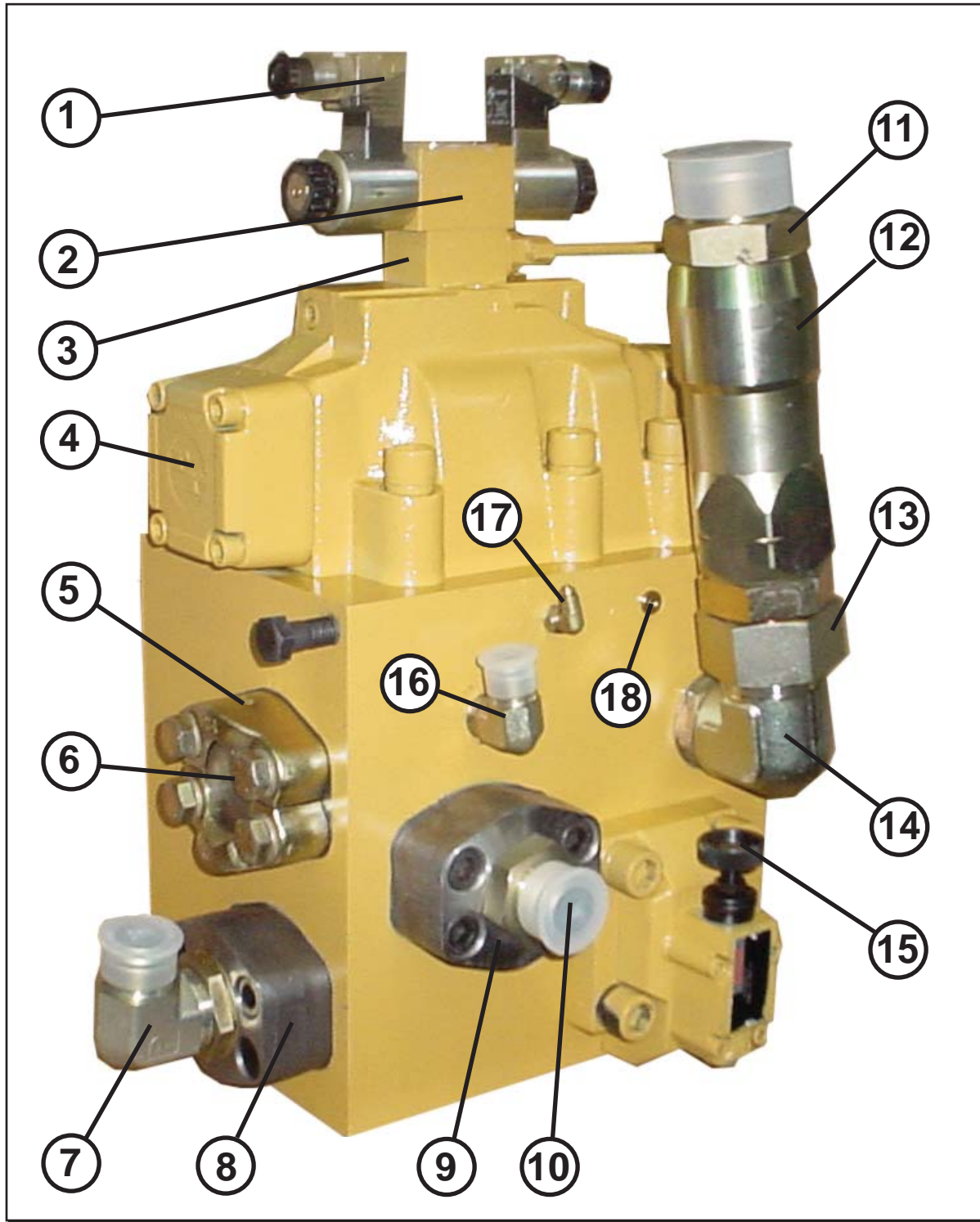




## VII. MODEL 630 POWER UNIT, (Continued...)

### VII-5. Hydraulic Components. (Continued...)

#### VII-5D. Drive Manifold.



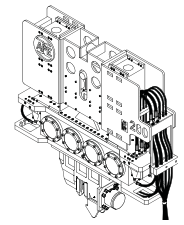
**Figure 7-I. Model 630 Drive Manifold (APE P/N 513028)**



# OPERATION / MAINTENANCE MANUAL

MODEL 200, 200T & 200-6 VIBRATORY DRIVER WITH MODEL 630 POWER UNIT

7032 SOUTH 196th - KENT, WA 98032 - (253) 872-0141 / FAX (253) 872-8710



## VII. MODEL 630 POWER UNIT, (Continued...)

### VII-5. Hydraulic Components. (Continued...)

#### VII-5D. Drive Manifold. (Continued...)

ITEM	QTY	DESCRIPTION	MFG	MFG P/N	APE P/N
1	2	DIN Connector	PPT	Z55L	
2*	1	Solenoid Valve	PPT	4WE6J6X/EG24N9K4	
3	1	Shuttle Body	Sun	GBS-S	513030
4	1	Control Valve	PPT	4WEH32H6X/6EG24N9EK4	
5	1	Split Flange		HFHFHK24	
6	1	Button		24F0PX	
7	1	Fitting		C50X 20-24 C50XS	
8	1	4-Bolt Flange & Kit		W48 24-24U	
9	1	4-Bolt Flange & Kit		W48 24-24U	
10	1	Fitting		20-24 F50X-S	
11	1	Fitting		32F50 X-S	
12	1	Check Valve		DC2000 F0 F0 65	
13	1	Fitting		32F650X-S	
14	1	Fitting		32-24C50X-S	
15	1	Relief Valve	PPT	DB30-1-5X/350X/12	
16	1	Fitting		12-8 C50X	
17	1	Fitting		4-4 C50X	
18	1	Fitting		4-HP50N	
2*		Consists of			
		Body	PPT	Sun GBS/S Body T-13A	
		Shuttle Valve	PPT	CSAA-EXN Shuttle	
		Fittings	PPT	0503-4-4	

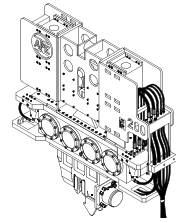
Table 7-D . Model 630 Drive Manifold Identification



# OPERATION / MAINTENANCE MANUAL

MODEL 200, 200T & 200-6 VIBRATORY DRIVER WITH MODEL 630 POWER UNIT

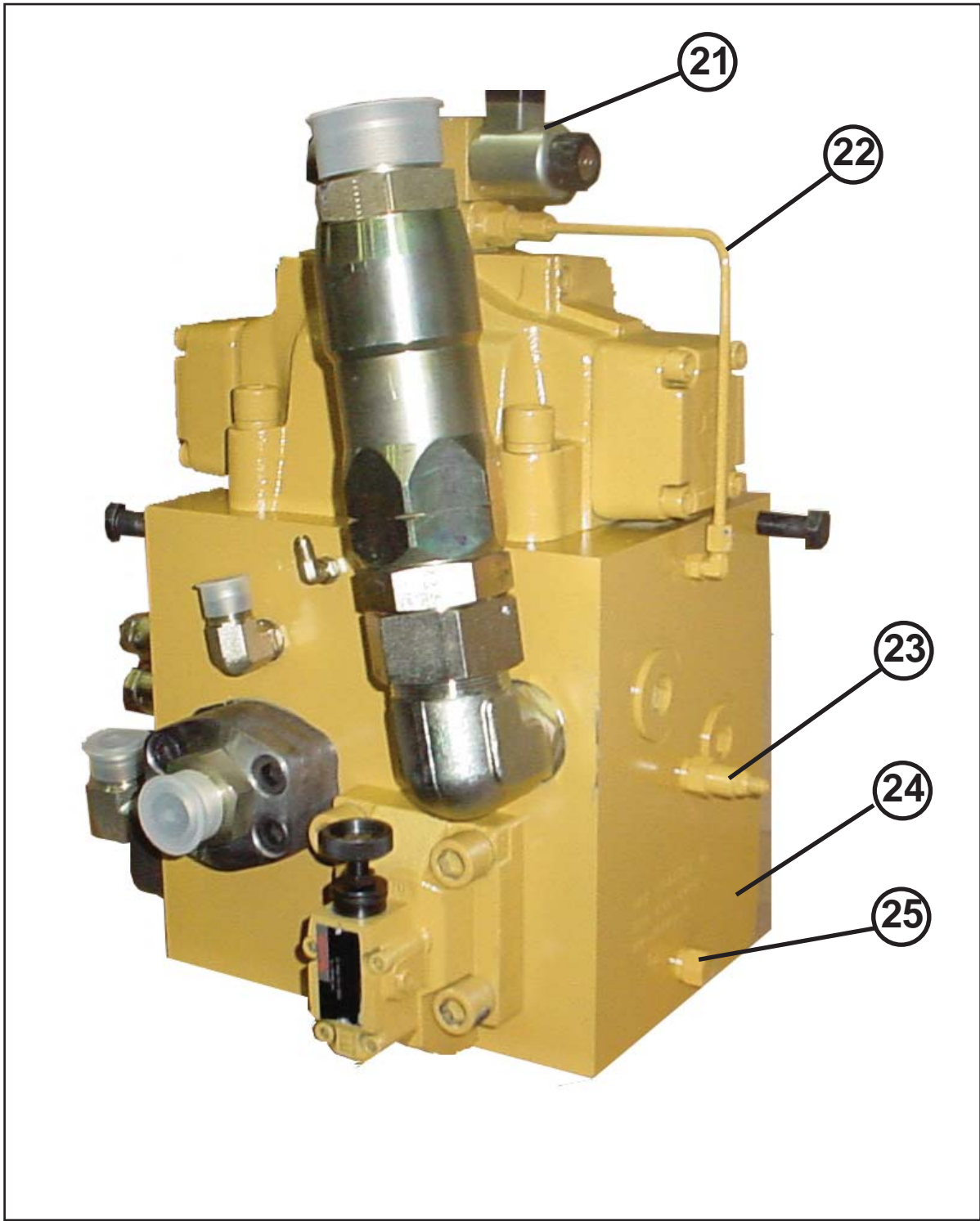
7032 SOUTH 196th - KENT, WA 98032 - (253) 872-0141 / FAX (253) 872-8710



## VII. MODEL 630 POWER UNIT, (Continued...)

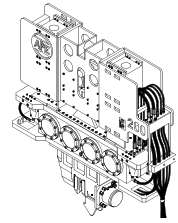
### VII-5. Hydraulic Components. (Continued...)

#### VII-5D. Drive Manifold. (Continued...)



**Figure 7-J. Model 630 Drive Manifold (Continued...)**

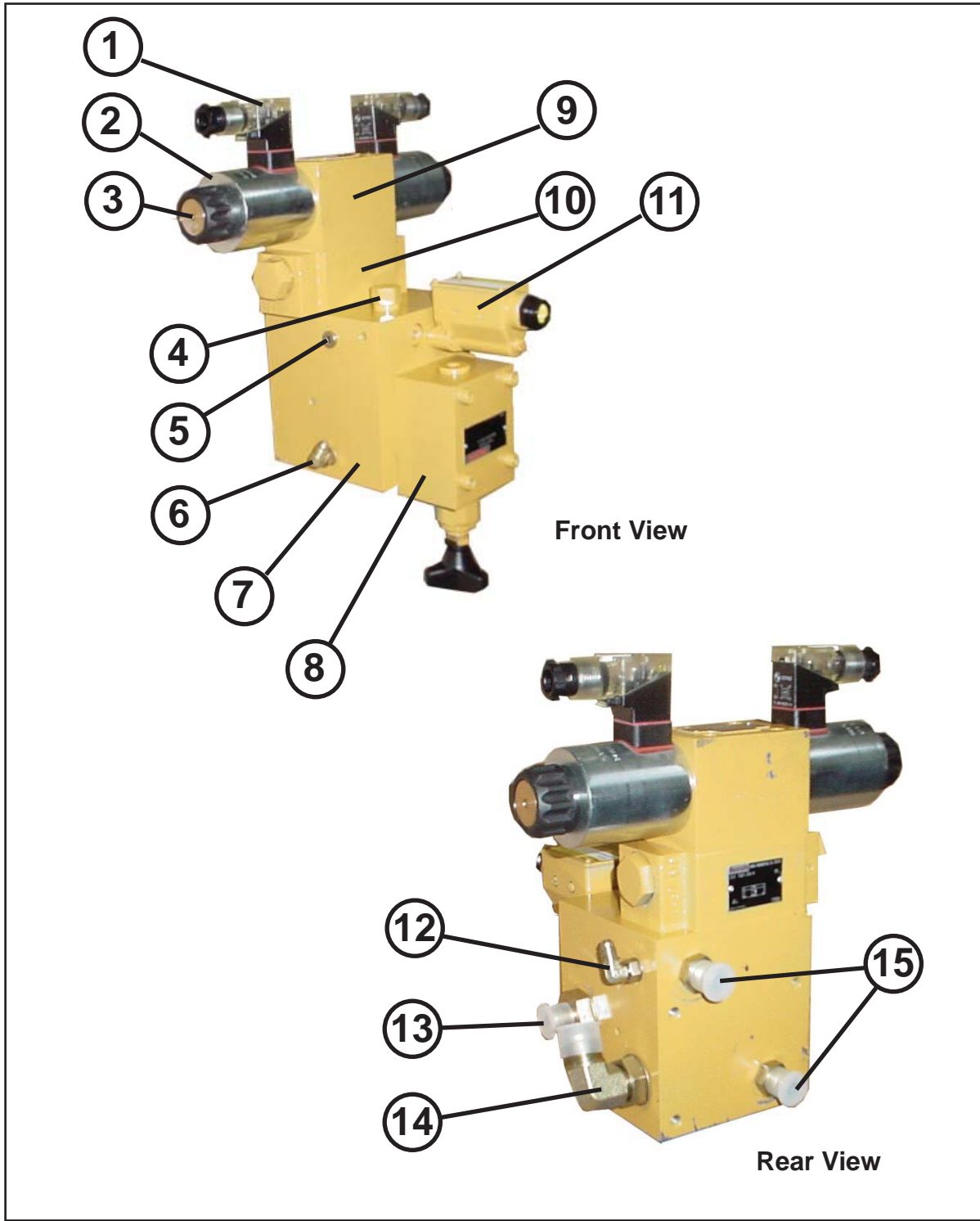




## VII. MODEL 630 POWER UNIT (Continued...)

### VII-5. Hydraulic Components. (Continued...)

#### VII-5E. Clamp Manifold.



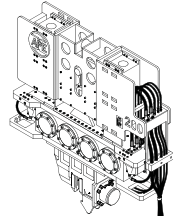
**Figure 7-K. Model 630 Clamp Manifold (APE P/N 523002)**



# OPERATION / MAINTENANCE MANUAL

MODEL 200, 200T & 200-6 VIBRATORY DRIVER WITH MODEL 630 POWER UNIT

7032 SOUTH 196th - KENT, WA 98032 - (253) 872-0141 / FAX (253) 872-8710



## VII. MODEL 630 POWER UNIT (Continued...)

### VII-5. Hydraulic Components. (Continued...)

#### VII-5E. Clamp Manifold. (Continued...)

ITEM	QTY	DESCRIPTION	MFG	MFG P/N	APE P/N
1	2	DIN Connector	PPT	255L	
2	2	Solenoid Coil	PPT	R900019793	
3	2	Cap / Coil Nut	PPT	R900019841	
4	1	Check Valve	PPT	CXDA-XCN	
5	1	Fitting	WFC	H50P	
6	1	Fitting	WFC	4-4C50X	
7	1	Manifold Block	PPT	MM-0737	
8	1	Relief Valve	PPT	DBDH10P1X/400/12	
9	1	Solenoid Valve	PPT	4WE10H3X/CG24N9K4 D05	
10	1	Sandwich Valve	PPT	Z2510B1-3X/V	
11	1	Pressure Switch	PPT	0E4-SBHS-8K	
12	1	Fitting	WFC	4-4 C50X	
13	1	Fitting	WFC	8-12 F50X	
14	1	Fitting	WFC	12-12 50N	
15	1	Fitting	WFC	8-8 F50X	

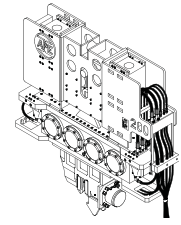
Table 7-E. Model 630 Clamp Manifold Identification



# OPERATION / MAINTENANCE MANUAL

MODEL 200, 200T & 200-6 VIBRATORY DRIVER WITH MODEL 630 POWER UNIT

7032 SOUTH 196th - KENT, WA 98032 - (253) 872-0141 / FAX (253) 872-8710



## VII. MODEL 630 POWER UNIT (Continued...)

### VII-5. Hydraulic Components. (Continued...)

#### VII-5F. Hosing: Identification/Routing.

Item	Hose Identification	Hose Routing	APE #
16	381-4 1/4" Hose, 13 1/2" O.A. Length w/ -4 JIC Swivel One End, -4 45 Deg JIC Swivel Other End (Parker 10643-4-4, 45 Deg;13743-4-4)	Clamp Manifold Pilot Hose To Relief Valve	
17	381-4 1/4" Hose, 110" O.A. Length w/ -4 JIC Swivels One End, 90 Deg -4 JIC Swivel Other End (Parker 10643-4-4, 90 Deg;13943-4-4)	Drive Manifold-Pressure Gauge Hose To Control Panel	
18	100 R13-16 1" Hose, 27" O.A. Length w/ 90 Deg -16 Code 62 Split Flanges Both Ends	Lower Right Drive Pump - Pressure Hose To Drive Manifold	
19	100 R13-16 1" Hose, 27" O.A. Length w/ 90 Deg -16 Code 62 Split Flange One End, 45 Deg -16 Code 62 Split Flange Other End	Lower Left Drive Pump-Pressure Hose To Drive Manifold	
20	100 R13-16 1" Hose, 30" O.A. Length w/ 45 Deg -16 Code 62 Split Flange One End, Straight -16 Code 62 Split Flange Other End	Middle Drive Pump - Pressure Hose To Drive Manifold	
21	301-32 2" Hose, 72" O.A. Length w/ -32 JIC Swivel Both Ends (Parker 10671-32-32)	Amot Valve Hose To Return Filter	
22	301-32 2" Hose, 117" O.A. Length w/ -32 JIC Swivel Both Ends (Parker 10671-32-32)	Amot Valve Hose To Cooler Inlet	
46	78C-12 3/4" Pressure Hose, 57" O.A. Length w/ -12 JIC Female Swivels Both Ends (Parker 10678-12-12)	Clamp Pump - Pressure Hose To Clamp Manifold	
47	421-12 3/4" Hose, 31" O.A. Length w/ -12 JIC Swivels Both Ends (Parker 10643-12-12)	Clamp Manifold Hose To Main Tank	
48	381-4 1/4" Hose, 107" O.A. Length w/ -4 JIC Swivels Both Ends (Parker 10643-4-4)	Clamp Manifold-Pressure Gauge Hose To Control Panel	
49	381-4 1/4" Hose, 107" O.A. Length w/ -4 JIC Swivels Both Ends (Parker 10643-4-4)	Clamp Manifold-Pressure Gauge Hose To Control Panel	
68	2" Longhorn Suction Hose, 8" Long, 2" Barbed King Nipple One End, 90 Deg Suction Adapter* Other End ( King Nipple; APE #411037)	Lower Left Drive Pump - Suction Hose From Tank Underside	
69	2" Longhorn Suction Hose, 14" Long, 2" Barbed King Nipple One End, 90 Deg Suction Adapter* Other End ( King Nipple; APE #411037)	Lower Right Drive Pump- Suction Hose From Tank Underside	
70	2" Longhorn Suction Hose, 20" Long, 2" Barbed King Nipple One End, Straight Suction Adapter* Other End ( King Nipple; APE #411037)	Middle Drive Pump - Suction Hose From Tank Underside	
71	421-12 3/4" Hose, 24" O.A. Length w/ -12 JIC Swivels Both Ends (Parker 10643-12-12)	Lower Left Drive Pump - Case Drain Hose To Main Tank	
72	421-12 3/4" Hose, 20" O.A. Length w/ -12 JIC Swivels Both Ends (Parker 10643-12-12)	Middle Drive Pump - Case Drain Hose To Main Tank	
73	421-12 3/4" Hose, 29" O.A. Length w/ -12 JIC Swivels Both Ends (Parker 10643-12-12)	Lower Right Drive Pump - Case Drain Hose To Main Tank	
74	881 1" Suction Hose, 65 1/2" O.A. Length w/ -16 JIC Swivels Both Ends (Parker 10643-16-16)	Clamp Pump - Suction Hose From Main Tank	
75	421-6 3/8" Hose, 79 1/2" O.A. Length w/ -6 JIC Swivel One End, 90 Deg 6 JIC Swivel Other End (Parker 10643-6-6, 90 Deg; 13943-6-6)	Clamp Pump - Case Drain Hose To Main Tank	
76	421-20 1 1/4" Hose, 25" O.A. Length w/ -20 JIC Swivels Both Ends (Parker 10643-20-20)	Auxiliary Tank Feed Hose To Main Tank	
77	301-32 2" Hose, 112" O.A. Length w/ -32 JIC Swivel Both Ends (Parker 10671-32-32)	Cooler Outlet Hose To Return Filter	
78	421-20 1 1/4" Hose, 50" O.A. Length w/ -20 JIC Swivels Both Ends (Parker 10643-20-20)	Hand Pump Hose To Siphon End	
79	421-16 1" Hose, 45" O.A. Length w/ -16 JIC Swivels Both Ends (Parker 10643-16-16)	Hand Pump Hose To Fill Filter	
80	-10 5/8" Fuel Hose, 14" O.A. Length w/ -10 JIC Swivels Both Ends (Parker 10643-10-10)	Fuel Tank Hose To Fuel / Water Separator	
81	-8 1/2" Fuel Hose, 40" O.A. Length w/ -8 JIC Swivels Both Ends (Parker 10643-8-8)	Fuel / Water Separator Hose To Fuel Filter	
82	421-12 3/4" Hose, 19" O.A. Length w/ -12 JIC Swivels One End, 90 Deg JIC Other End (Parker 10643-12-12,13942-12-12)	Fuel Return Line	

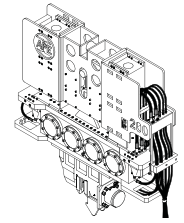




# **OPERATION / MAINTENANCE MANUAL**

MODEL 200, 200T & 200-6 VIBRATORY DRIVER WITH MODEL 630 POWER UNIT

7032 SOUTH 196th - KENT, WA 98032 - (253) 872-0141 / FAX (253) 872-8710



## **VII. MODEL 630 POWER UNIT (Continued...)**

### **VII-6. Electrical Controls: (Understanding How They Work)**

The Main Control Panel (located behind one of the doors on the left side of the Power Unit) contains all of the equipment necessary to Start, Control, and Monitor the Engine, as well as control the Vibro functions. Remote control of the Vibro functions can be achieved by plugging either a Remote Pendant Switch, or a Radio Receiver into the 12 pin receptacle, located on the bottom of the panel. The Pendant Switch will allow the operator to move about in approx. a 50 ft radius of the Power Unit. The Radio will allow the operator to move about in approx. a 400 ft radius of the Power Unit.

#### **VII-6A. Main Circuit Breaker**

A circuit breaker is provided to protect the control wiring in the event of an electrical overload or a shorted circuit. If the circuit breaker should trip, find and repair the fault, then reset the breaker by pressing the circuit breaker reset button on the face of the Control Panel.

#### **VII-6B. Tachometer**

A digital tachometer, located on the front of the control panel, is provided to monitor the engine RPM. A magnetic sensor picks up a signal from the flywheel, and sends it to the tachometer. If there is reason to doubt the accuracy of the tachometer, check the engine RPM with a phototach, then calibrate the tachometer Gauge. The factory should be consulted for proper setting of the tach switches.

#### **VII-6C. Hourmeters**

Two hourmeters are on the Control Panel, one on the face of the panel, and one inside the panel. The hourmeter on the face of the panel monitors the time that the engine is running. The hourmeter inside the panel monitors the time that the "Forward Drive" is operating.

#### **VII-6D. Engine Safety Shutdown Switch (Murphy Magnetic Switch)**

Mounted to the back side of the Control Panel Door, is a Murphy Magnetic switch with a manual reset button protruding through the front of the Panel Door. When the contact on the switch is closed, power is supplied to the fuel valve solenoid, the hourmeter, and the "System OK" light. When the contact is open, the above items will be de-energized, and the engine will not run. The contact can be manually closed by pressing the "Reset" button on the face of the control panel. The contact will remain latched closed, unless the coil on the switch is energized. Each time the coil is energized, the contact will be unlatched, and the contact will open, to stop the engine. There are five switches that can energize the coil on the Murphy magnetic Switch, to stop the engine, (Engine Oil Pressure Gauge, Engine Coolant Temperature Gauge, Hydraulic Oil Temperature Gauge, Hydraulic Oil Level Switch, and Emergency Stop Button on either the Pendant Switch, or the Radio).

#### **VII-6E. Murphy "Engine Oil Press" Gauge**

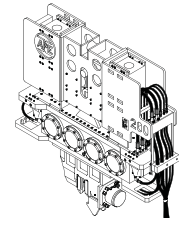
The Engine Oil Pressure Gauge is located on the door of the Main Control Panel. A low cutoff switch is located inside the Murphy "Engine Oil Press" Gauge. When the engine oil pressure is too low, the switch will close to energize the coil in the Murphy Mag Switch. The cutoff pressure has been set at the factory. If the setting should need to be changed, use the adjustment screw provided in the front of the Gauge. A 1/16" allen wrench is required. Each time the engine is to be started, the Murphy Mag Switch coil will be energized by the switch in this Gauge. To start the engine, one must press and hold the manual reset button on the Murphy Mag Switch until sufficient engine oil pressure is achieved. Sufficient oil pressure has been achieved when the "Oil Press" light on the face of the Control Panel goes out.)



# **OPERATION / MAINTENANCE MANUAL**

MODEL 200, 200T & 200-6 VIBRATORY DRIVER WITH MODEL 630 POWER UNIT

7032 SOUTH 196th - KENT, WA 98032 - (253) 872-0141 / FAX (253) 872-8710



## **VII. MODEL 630 POWER UNIT (Continued...)**

### **VII-6F. Murphy “Engine Coolant Temp” Gauge**

The Engine Coolant Temperature Gauge is located on the door of the Main Control Panel. A high cutoff switch is located in the Murphy “Engine Coolant Temp” Gauge. When the engine temperature is too high, the switch will close to energize the coil in the Murphy Mag Switch. The cutoff pressure has been set at the factory. If the setting should need to be changed, use the adjustment screw provided in the front of the Gauge. A 1/16” allen wrench is required. (Do not set the cutoff temperature above 220 deg F. without factory permission)

### **VII-6G. Murphy “Hyd Oil Temp” Gauge**

The Hydraulic Oil Temperature Gauge is located in the Gauge Assembly on the left of the Control Panel. A high cutoff switch is located in the Murphy “Hyd Oil Temp” Gauge. When the hydraulic oil temperature is too high, the switch will close to energize the coil in the Murphy Mag Switch. The cutoff pressure has been set at the factory. If the setting should need to be changed, use the adjustment screw provided in the front of the Gauge. A 1/16” allen wrench is required.

### **VII-6H. Hydraulic Oil Level Float Switch**

The “Hyd Oil Level” float switch is located in the hydraulic oil reservoir, next to the sight Gauge. A glass window is provided in the switch so that the float and oil level can be observed. If the oil level gets too low, the switch will close to energize the coil in the Murphy Mag Switch.

### **VII-6I. Pendant “Emergency Stop” Button**

To stop the engine in an emergency, press the “Emergency Stop” button on the hand held Pendant Switch. This “Emergency Stop” switch will work, regardless of the position of the “Local-Pendant” selector Switch.

### **VII-6J. Radio “Emergency Stop” Button**

To stop the engine in an emergency, press the red “Emergency Stop” button located near the antenna on the radio transmitter. This switch will work, regardless of the position of the “Local-Pendant” selector switch. NOTE: In order for the radio “Emergency Stop” button to work, both the Radio Receiver and the Radio Transmitter have to have been on, and operational.

### **VII-6K. Pilot Lights**

There are five pilot lights on the face of the control panel that are associated with the Safety Shutdown Switch discussed above.

1. “System OK” light. A “System OK” light is an indication that the Engine Oil Pressure, Engine Coolant Temperature, Hydraulic Oil Temperature, and the Hydraulic Oil Level are all okay. When the “System OK” light is not lit, the engine will have been automatically stopped. The problem can be detected by observing the following lights.
2. “Engine Oil Press” light. Any time the engine oil pressure is too low, this light will be on, (with the following exception). If the “Engine Coolant Temperature Gauge”, the Hydraulic Oil Temperature Gauge, or the Hydraulic Oil Level Switch has stopped the engine, the “Engine Oil Press” light will not be on; but, one of the following lights will be on.
3. “Engine Coolant Temp” light. If the Engine Coolant Temp is too high, this light will be on.
4. “Hydraulic Oil Temp” light. If the Hydraulic Oil Temperature is too high, this light will be on.
5. “Hydraulic Oil Level” light. Any time the Hydraulic Oil Level is too low, this light will be on.

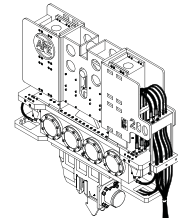
In addition to the above, there is a pilot light in each of the terminal connectors on the solenoid valves. By observing these lights, one can tell which solenoids are energized.



# **OPERATION / MAINTENANCE MANUAL**

MODEL 200, 200T & 200-6 VIBRATORY DRIVER WITH MODEL 630 POWER UNIT

7032 SOUTH 196th - KENT, WA 98032 - (253) 872-0141 / FAX (253) 872-8710



## **VII. MODEL 630 POWER UNIT (Continued...)**

### **VII-6L. Engine Control Switch (“OFF-on-START”)**

The Engine Control Switch is located on the front of the control panel, and is used to start and stop the diesel engine, as well as control power to all other electrical equipment on the power unit. This switch must be in the “on” position before the engine or any of the other electrical components will operate. The “off” and “on” positions are detented, but the “start” position is spring loaded to the “on” position. Turning the switch to the “start” position will energize the starter motor on the engine.

### **VII-6M. “LOCAL - PENDANT” Switch**

This switch is also located on the main control panel, and determines the location from which the vibro can be operated. The vibro can not be operated from more than one location at a time. When this switch is turned to the “local” position, the vibro can be operated only by the switches on the power unit control panel. In the “pendant” position, operation of the vibro is controlled by either the Hand Held Pendant Switch, or the Radio (depending on which one is plugged into the bottom of the Control Panel).

CAUTION should be used when changing the position of this switch. Check to make sure that all of the Drive “Forward/Reverse” switches, and “Clamp” switches (including the Radio) are turned “off” before turning this switch. If any one of the above switches are “on”, the vibro eccentrics or clamp could be accidentally activated, causing mechanical damage or personal injury.

If neither the Hand Held Pendant nor the Radio is plugged into the Receptacle on the bottom of the Control Panel, this switch must be in the “local” position before the engine can be started.

### **VII-6N. Governor Control Switches (“RAISE-off-LOWER”)**

Governor Control switches can be found on the Main Control Panel, the Held Pendant, and/or the Radio Transmitter. The “Local-Pendant” switch determines which one is operable. To increase the engine rpm, turn the appropriate governor control switch to the “Raise” position. To decrease the engine rpm, turn the switch to the “Lower” position. On power units equipped with Caterpillar engines, the switches are connected directly to the engine governor. On power units equipped with Cummins engines, the switches control a Murphy Actuator, which in turn, operates a control arm on the engine governor. On both the Caterpillar and Cummins models, there is a manual throttle control, which can override the electric control. The electric control cannot lower the engine rpm below that set by the manual throttle control.

### **VII-6O. Clamp Control Switches (“OPEN-off-CLOSE”)**

A Clamp Control Switch can be found on the Main Control Panel, the Hand Held Pendant, and/or the Radio Transmitter. The “Local-Pendant” switch determines which one is operable.

The Clamp Control Switches on the Control Panel and the Hand Held Pendant are detented in the “off” and “close” positions. The “open” position is spring loaded back to the “off” position.

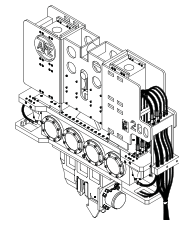
When the ‘active’ Clamp Control Switch is in the “off” position, oil from the Clamp Pump is routed through the Clamp Solenoid Valve back to tank.



# OPERATION / MAINTENANCE MANUAL

MODEL 200, 200T & 200-6 VIBRATORY DRIVER WITH MODEL 630 POWER UNIT

7032 SOUTH 196th - KENT, WA 98032 - (253) 872-0141 / FAX (253) 872-8710



## VII. MODEL 630 POWER UNIT (Continued...)

### VII-60. Clamp Control Switches (“OPEN-off-CLOSE”) (Continued...)

When the ‘active’ Clamp Control Switch is turned to the “open” position, The “open” solenoid on the Clamp Valve is energized, causing oil to be directed to the rod end of the Clamp Cylinder, provided the drive “Forward/Reverse” Switch is in the “off” position. (The clamp “open” solenoid cannot be energized when the “Drive Forward” switch is activated.) If the Clamp Control Switch is held in the “open” position after the clamp is fully open, oil pressure will build in the system until oil is flowing over a pressure relief valve, creating heat.

When the ‘active’ Clamp Control Switch is turned to the detented “Close” position, the “close” solenoid on the Clamp valve is energized, causing oil to be directed to the blind end of the Clamp Cylinder. Once the Clamp is closed, and sufficient oil pressure (3500psi) has built in the system, a pressure switch will open the circuit to the solenoid valve, and energize a pilot light located in the Clamp Control Switch Operator. A lit pilot light in the Clamp Control Switch Operator is an indication that there is enough oil pressure in the clamp circuit to safely run the vibro eccentrics.

If oil pressure in the Clamp circuit should bleed off to a predetermined level(4000psi), the pressure switch will de-energize the pilot light, and re-energize the “close” solenoid on the Clamp valve until pressure in the clamp circuit reaches 4500psi again. This cycle will continue until the Clamp switch is turned to the “off “ position.

Operation of the Clamp “open/close” switch on the radio transmitter is similar, but slightly different, in that the switch on the Radio Transmitter is not detented in the “close” position.

The first time the Clamp switch on the transmitter is moved to the “close” position, the radio output signal to the “close” solenoid on the Clamp valve will be latched on. The oil pressure switch will function the same as above, but the operator will have to look on the control panel or the hand held pendant switch to observe the pilot light.

The next time the Clamp switch on the transmitter is moved to the “close” position, the radio output signal to the “close” solenoid on the Clamp valve will be turned “off”. Each time the switch is moved to the “close” position, the radio output will be alternately turned “on”, or “off”. The radio’s Clamp “close” output signal can also be turned “off” by moving the switch to the “open” position.

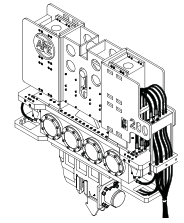
As long as the Clamp switch on the radio transmitter is held in the “open” position, the radio will send an output signal to the “open” solenoid on the Clamp valve, provided both the “Drive Forward” and “Drive Reverse” outputs are turned off. (The clamp “open” solenoid cannot be energized when the “Drive Forward” output is activated.) If the Clamp Control Switch is held in the “open” position after the clamp is fully open, oil pressure will build in the system until oil is flowing over a pressure relief valve, creating heat.



# **OPERATION / MAINTENANCE MANUAL**

MODEL 200, 200T & 200-6 VIBRATORY DRIVER WITH MODEL 630 POWER UNIT

7032 SOUTH 196th - KENT, WA 98032 - (253) 872-0141 / FAX (253) 872-8710



## **VII. MODEL 630 POWER UNIT (Continued...)**

### **VII-5P. Drive Control Switches (“FORWARD/off/REVERSE”)**

Drive Control Switches can be found on the Main Control Panel, the Hand Held Pendant, and/or the Radio Transmitter. The “Local-Pendant” Selector Switch determines which one is operable.

The Drive Control Switches on the Control Panel and the Hand Held Pendant are detented in all three positions. They must be in the “off” position, before the engine can be started.

When operating a Drill, both the “Forward” and “Reverse” positions can be used. The “Forward” position would be used to drive the drill forward. The “Reverse” position would be used to drive the drill backwards.

When operating the eccentrics on a vibro, only the “Forward” drive should be used. If the “Reverse” drive is used, the majority of the oil will pass through the anti-cavitation valves located in the vibro suppresser housing, and the vibro eccentrics will not run properly.

The operation of the switches on the Radio Transmitter are similar to the Control Panel and Pendant operation, with the following exception. There are two switches on the transmitter, one for “Forward”, and one for “Reverse”. Neither is detented. When the “Drive Forward” switch on the transmitter is moved to the “on” position, the “Drive Forward” output signal from the radio is latched “on”. To turn the “Drive Forward” output signal “off”, move the “Drive Forward” switch on the transmitter to the “off” position. The “Reverse” output works the same way.

It is possible to plug reverse the drive motor by alternately moving the “Forward” and “Reverse” switches on the transmitter to the “on” position, without using the “off” positions. This is hard on the equipment, and should be avoided. If a drive is turned “on”, it should always be turned “off”, and the equipment allowed to stop, before the opposite drive is turned “on”.

### **VII-6Q. Preparing the Electrical System for Engine Startup.**

The following procedure should be followed at Engine Startup:

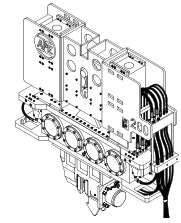
1. The Circuit Breaker must be closed (Pushed in and locked).
2. Turn the Clamp Switches on both the Control Panel and the Pendant to the ‘Off’ position.
3. Turn the Drive Switch on both the control panel and the Pendant to the ‘Off’ position.
4. If neither a Hand Held Pendant, nor a Radio is plugged into the receptacle on the bottom of the Control Panel, this switch must be in the ‘Local’ position.
5. Check to make sure that both the Manual Throttle Control, and the Governor Control is properly set.
6. Turn the Engine Control Switch to the ‘On’ position.
7. Check the Pilot Lights on the face of the Control Panel. If any of the lights, other than the “Engine Oil Pressure” light is on, correct the problem before proceeding. If the ‘Engine Oil Pressure’ light is on, proceed to step #8.
8. Depress and hold the button on the Engine Safety Shutdown Switch (Murphy Switch). This button must be depressed until Engine Oil Pressure is present.
9. Turn the Engine Control Switch to the ‘Start’ Position to engage the Starter Motor.
10. Once Engine Oil Pressure is present, release the Emergency Shutdown Switch.



# OPERATION / MAINTENANCE MANUAL

MODEL 200, 200T & 200-6 VIBRATORY DRIVER WITH MODEL 630 POWER UNIT

7032 SOUTH 196th - KENT, WA 98032 - (253) 872-0141 / FAX (253) 872-8710

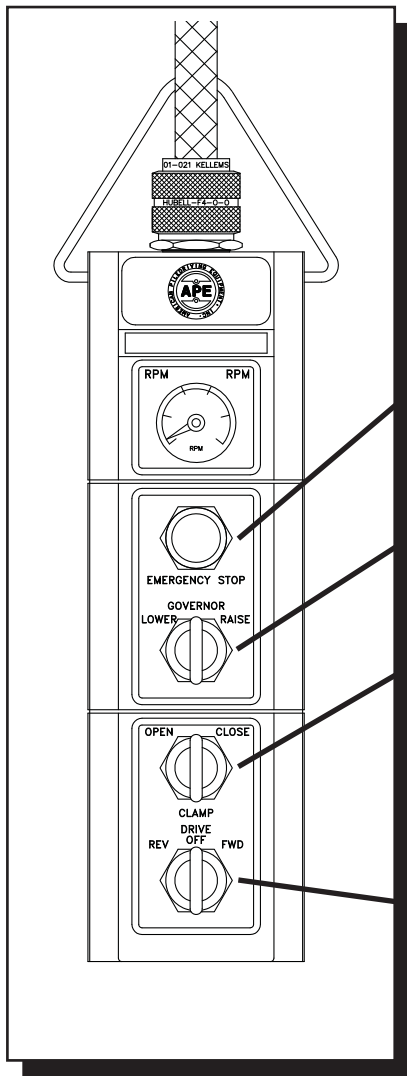


## VII. MODEL 630 POWER UNIT (Continued...)

### VII-7. Remote Control Pendant

A "REMOTE HAND HELD CONTROL PENDANT" is provided to allow operation of the power unit at a distance of up to 50 feet (15 meters) and can be extended using 50 foot extension cables. The "REMOTE HAND HELD CONTROL PENDANT" is connected to the control panel via a multiconnector plug.

The Pendant Switch is particularly handy as a trouble shooting tool, in that the operator can position himself near the Control Valves while checking them. To make the Pendant Switches operable, turn the 'Local-Pendant' Switch to the 'Pendant' position, and the Engine Control Switch to the 'On' Position. (The Engine does not need to be running.) Each time a solenoid is energized, a pilot light on the connector to that solenoid should light up.



**ENGINE EMERGENCY SHUTDOWN SWITCH**  
Press and hold to shut engine off. Do not use to shut engine off at the end of shift. Shut unit off at panel at end of shift. Button is for emergency only.

**ENGINE THROTTLE "RAISE/LOWER" RPM**  
Three Position Switch. Press and hold button to raise or lower deisel engine rpm.

**CLAMP OPEN/CLAMP CLOSE**  
Lighted switch. Move to close to extend jaw and clamp vibro to pile. Light comes on when clamp is closed and locked. Turn to open to retract jaw and release vibro from pile. Switch must remain in closed position to hold clamp to pile. Sometimes the light will not come on. It could be burnt out or shorted. Check clamp pressure gauge and make sure it reads at least 3800 psi before vibrating any pile. Contact APE if light is not working.

**FORWARD/OFF/REVERSE**  
Three position switch. Turn to forward to operate vibro. Turn to off to stop vibro. Turn to reverse when using power unit to run a drill motor. Vibro is not supposed to vibrate in reverse. If it does then switch the two yellow cables labeled "drive" and "reverse" located on the other side of the control panel.

**Figure 7-L. Remote Control Pendant**

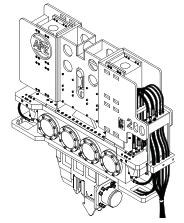
**WARNING:** Never leave vibro clamped to a pile without the crane line attached. The clamp cylinder could bleed off causing the vibro to drop. Never hoist a pile in the air without a safety line attached to the pile. Should the clamp close line become damaged and leak, the clamp cylinder could lose pressure and drop the pile.



# OPERATION / MAINTENANCE MANUAL

MODEL 200, 200T & 200-6 VIBRATORY DRIVER WITH MODEL 630 POWER UNIT

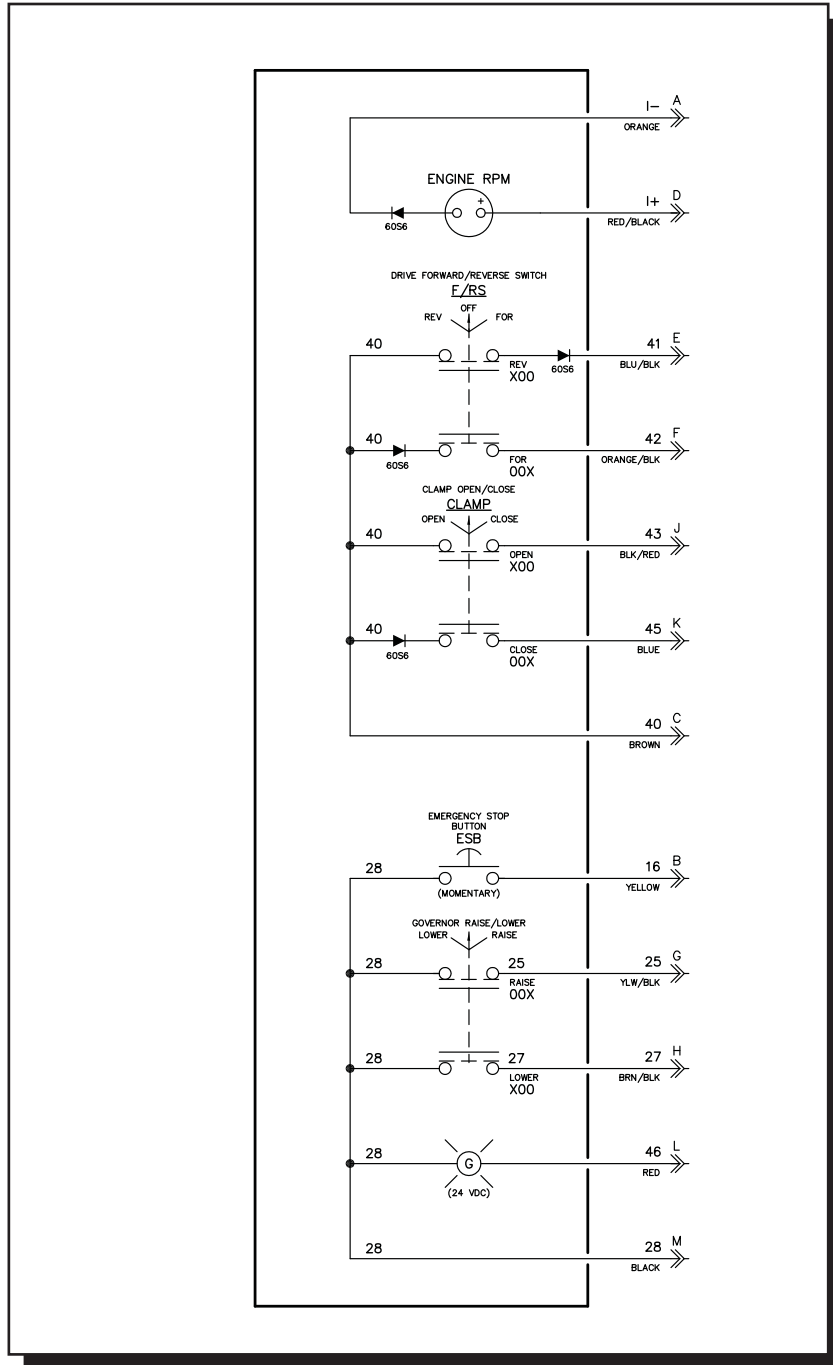
7032 SOUTH 196th - KENT, WA 98032 - (253) 872-0141 / FAX (253) 872-8710



## VII. MODEL 630 POWER UNIT (Continued...)

### VII-7A. Remote Pendant Wiring Diagram

The following is the pin wiring configuration and the wire colors of the amphenol connectors for the remote control pendant cable.



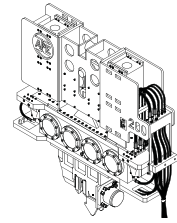
**Figure 7-M. Remote Pendant Wiring Diagram**



# **OPERATION / MAINTENANCE MANUAL**

MODEL 200, 200T & 200-6 VIBRATORY DRIVER WITH MODEL 630 POWER UNIT

7032 SOUTH 196th - KENT, WA 98032 - (253) 872-0141 / FAX (253) 872-8710



## **- APPENDIX A -** **CAT C-18 ENGINE**

### **A-1. ENGINE OPERATION INSTRUCTIONS**

The following sections are basic instructions for maintenance and operation of the **APE Model 630 Power Unit Engine**. All maintenance should be performed by qualified personnel who are familiar with the equipment. (Consult the factory for additional information.)

#### **A-1A. PRE-START INSPECTION AND PROCEDURES**

1. Make a "walk-around" inspection of the engine and components for the oil, water or fuel leaks and general appearance. Correct minor adjustments before they develop into major repair jobs.
2. Check the crankcase oil level. Maintain the oil level between the ADD and FULL marks on the dipstick. See OIL SPECIFICATIONS for type of oil to use.
3. Check oil level(s) on driven equipment.

**WARNING: Check the engine coolant level when the engine is cool. If the engine is warm, steam may spray outward under high pressure and cause personal injury.**

4. Check the engine jacket coolant level. Slowly turn the pressure cap until the cap is removed. Maintain coolant level to the base of the fill pipe.
5. Check the fuel supply. Keep fuel tanks full, as partially filled tanks will collect moisture. See the FUEL SPECIFICATIONS for type of fuel.

#### **KEEP THE FUEL SUPPLY CLEAN**

6. Open the raw water valve on the engine jacket heat exchanger system (if so equipped). Prime the raw water pump if the raw water system has been drained.
7. Reset shutoff devices. See the topic, ATTACHMENTS, Emergency Shutoff Devices and Alarms. If the engine is equipped with an air safety shutoff control, and was tripped to the shutoff position, reset the latch to the run position.
8. Open the fuel supply valve. If the engine has not run for some time it may be necessary to prime the system. See the topic, PRIMING THE FUEL SYSTEM.
9. Disconnect any battery charger which is not protected against starting motor drain.
10. Disengage the clutch, or open the circuit breaker on a generator set.

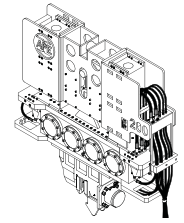




# **OPERATION / MAINTENANCE MANUAL**

MODEL 200, 200T & 200-6 VIBRATORY DRIVER WITH MODEL 630 POWER UNIT

7032 SOUTH 196th - KENT, WA 98032 - (253) 872-0141 / FAX (253) 872-8710



## **- APPENDIX A - CAT C-18 ENGINE**

### **A-1B. STARTING THE ENGINE.**

**CAUTION: Do not engage the starter when the flywheel is moving.**

#### **Electric Starting**

1. Move the governor control lever to approximate half engine speed position.
2. Use starting aids if required.
3. Push the START button; or turn the HEAT START switch to the START position, depending upon the control the engine has. Release the control as soon as the engine starts.

For generator sets, place the AUTO-MAN switch in the MAN position to crank the engine. As soon as the engine starts, and the engine speed reaches 600 rpm and oil pressure is approximately 22 psi (1.5 kg/CM<sup>2</sup>), the starter motor will disconnect from the circuit. (The STOP position is used to stop the diesel engine.)

If the engine fails to start within 10 seconds, move the governor control lever to the fuel off position, then continue to crank for 10 seconds. This will clear the cylinders of unburned fuel.

If the engine fails to start after 30 seconds of cranking, allow the engine to cool for 2 minutes before repeating the starting procedure.

**CAUTION: Prolonged cranking at low oil pressure can activate the mechanical safety shut-off. If the reset lever is in the shut-off position, reset the mechanical shut-off control.**

**CAUTION: NEVER use starting aids when the engine is warm and running.**

#### **Air Starting**

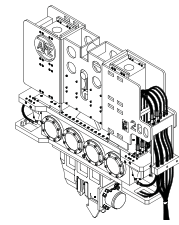
1. Open and close the bleed valve on the bottom of the air tank to drain condensation and oil carryover.
2. Check the air supply pressure. The air start must have 100 PSI (7 kg/cm<sup>2</sup>) to operate properly.
3. Keep oil level, in the oiler jar, at least half full. Add oil if necessary.
4. Push the air valve control in to crank the engine. As soon as the engine starts, release the valve.



# **OPERATION / MAINTENANCE MANUAL**

MODEL 200, 200T & 200-6 VIBRATORY DRIVER WITH MODEL 630 POWER UNIT

7032 SOUTH 196th - KENT, WA 98032 - (253) 872-0141 / FAX (253) 872-8710



## **- APPENDIX A -** **CAT C-18 ENGINE**

### **A-1. OPERATION INSTRUCTIONS. (Continued...)**

#### **A-1C. ENGINE OPERATION.**

After the engine starts, and at frequent intervals while the engine is operating, the gauges should be observed. Determine the normal reading for each gauge. Investigate the cause whenever there is a significant change in the reading.

#### **Tachometer**

The tachometer indicates engine RPM. The high idle RPM and the full load RPM are stamped on the engine's information plate. The engine can be operated between these two speed limits for long periods of time without shortening engine life. Prolonged operation at high idle with little or no load can cause adverse engine operation.

#### **Engine Oil Pressure**

If the gauge reading fluctuates after the load is stable:

1. Remove the load.
2. Reduce engine speed to low idle.
3. Observe the oil level. Maintain the oil level between the ADD and FULL mark on the dipstick. If the reading continues to fluctuate when the oil level is correct, stop engine and call your Caterpillar dealer.

#### **Engine Jacket Water Temperature**

The engine should operate within the NORMAL (green) range. If the engine is operating in the (red) range and steam becomes apparent:

1. Reduce the load and engine RPM.
2. Inspect for coolant leaks.
3. Determine if the engine must be shut down immediately; or if the engine can be safely cooled by reducing the load. (See COOLING SPECIFICATION INSTRUCTIONS.)

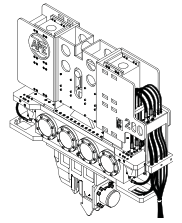
**CAUTION: Do not add cold water to a hot engine: Cracking of engine components may occur. Allow the engine to cool, then add coolant.**



# **OPERATION / MAINTENANCE MANUAL**

MODEL 200, 200T & 200-6 VIBRATORY DRIVER WITH MODEL 630 POWER UNIT

7032 SOUTH 196th - KENT, WA 98032 - (253) 872-0141 / FAX (253) 872-8710



## **- APPENDIX A - CAT C-18 ENGINE**

### **A-1C. ENGINE OPERATION (Continued...)**

#### **Water Temperature Gauge**

If the temperature gauge reading registers in or near the cold range (white) while operating under load:

1. Check the water temperature gauge for accuracy.
2. Check the temperature regulators for proper temperature range. Replace regulators if necessary.

#### **Fuel pressure**

If the fuel filter gauge registers in the OUT range, clean the primary fuel filter, if so equipped. Install new secondary or final fuel filter elements if gauge still registers OUT. See the FUEL MAINTENANCE INSTRUCTIONS and FUEL SPECIFICATIONS.

#### **Ammeter:**

The ammeter reading is normal when the indicator is at or on the (+) side of zero, when the engine is running at rated speed. If indicator is to the left (-) side of zero, investigate and correct cause.

#### **Air Cleaner Service Indicator**

When the gauge indicator locks in the red range, service the air cleaner. With the engine stopped.

#### **Calibrated Gauges**

Calibrated gauges are used on some engines to monitor the engine systems. If an abnormal engine condition develops, determine and analyze and correct the cause before a failure and downtime occurs.

If any of the gauges register at or outside the operating limits, investigate and correct any malfunction. See TROUBLESHOOTING for guidance.

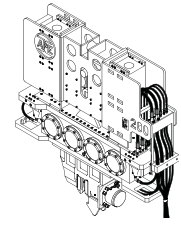
**WARNING: Shut the engine down if work on or around the engine is required.  
DO NOT OPERATE THE ENGINE WITH THE GAUGES REGISTERING AT OR OUTSIDE  
THE LIMITS.**



# **OPERATION / MAINTENANCE MANUAL**

MODEL 200, 200T & 200-6 VIBRATORY DRIVER WITH MODEL 630 POWER UNIT

7032 SOUTH 196th - KENT, WA 98032 - (253) 872-0141 / FAX (253) 872-8710



## **- APPENDIX A - CAT C-18 ENGINE**

### **A-1C. ENGINE OPERATION (Continued...)**

#### **Altitude Operation**

The fuel system settings and altitude limits are stamped on the engine information plate. When an engine is moved to a higher altitude, these settings must be changed by your Caterpillar dealer in order to prevent damaging the turbocharger, and to provide maximum engine efficiency. If the engine is moved to a lower altitude than that which is stamped on the engine information plate, the engine can be operated safely; however, it will deliver less than rated horsepower, and the fuel settings should be changed by your Caterpillar dealer to obtain rated horsepower.

#### **Stopping**

1. Flywheel clutch operation: Quickly pull the clutch lever to the released position.
2. Reduce engine speed to half speed. Run for 5-10 minutes to cool engine.
3. Reduce engine speed to low idle.
4. Observe the crankcase oil level while the engine is idling. Maintain the oil level between the ADD and FULL marks on the side of the dipstick stamped, CHECK WITH ENGINE RUNNING. See the LUBRICATION AND MAINTENANCE SECTION.
5. Stop the engine.

#### **After Stopping Checks And Procedures**

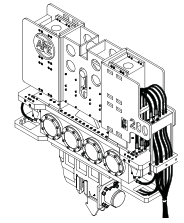
1. Fill the fuel tank. See the LUBRICATION AND MAINTENANCE SECTION: Fuel Tank Maintenance.
2. Drain the raw water system if below freezing temperatures are expected; see: Draining Raw Water System.
3. If below freezing temperatures are expected, allow the engine jacket water expansion tank to cool, then check the coolant for proper antifreeze protection. Add permanent-type antifreeze, if required.
4. Repair any leaks, make major adjustments, tighten loose bolts, etc.
5. Observe the Service Meter reading. Perform the periodic maintenance as instructed in the LUBRICATION AND MAINTENANCE CHART.



# **OPERATION / MAINTENANCE MANUAL**

MODEL 200, 200T & 200-6 VIBRATORY DRIVER WITH MODEL 630 POWER UNIT

7032 SOUTH 196th - KENT, WA 98032 - (253) 872-0141 / FAX (253) 872-8710



## **- APPENDIX A -** **CAT C-18 ENGINE**

### **A-1C. ENGINE OPERATION (Continued...)**

#### **Starting The Engine**

1. Perform all prestart checks outlined previously.
2. Place the CONTROL switch in the MANUAL position to crank the engine.
3. When the engine starts and engine rpm reaches 600 rpm and the oil pressure registers 22 psi (1.5 kg/cm<sup>2</sup>) the starting motor will automatically disconnect from the start circuit.
4. Start the load.
5. Regulate the engine speed with the RAISE LOWER switch to the required instrument panel gauge readings.

#### **Stopping The Engine**

1. Remove the load.
2. Reduce engine speed to low idle: Push down and hold the RAISE-LOWER switch until the engine low idle speed is reached.
3. While the engine is idling, check the engine oil level. Oil level must be maintained between the ADD and FULL marks on the side of the dipstick marked "CHECK WITH ENGINE RUNNING".
4. Stop the engine.

#### **(Solenoid Shutoff)**

a. Move the control switch to the STOP or OFF positions. (Do not confuse this with the "RAISE-LOWER" switch.)

#### **(PSG Governor:)**

b. Move the shutoff lever forward, or hold the lever up, depending upon installation. Hold the lever in this position until the engine stops.

5. Fill the fuel tank. See the LUBRICATION AND MAINTENANCE section.
6. Drain the raw water system if below freezing temperatures are expected.

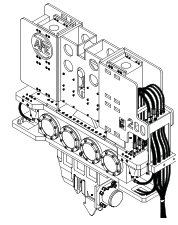
Observe the Service Meter reading. Perform the periodic maintenance as instructed in the LUBRICATION AND MAINTENANCE CHART.



# OPERATION / MAINTENANCE MANUAL

MODEL 200, 200T & 200-6 VIBRATORY DRIVER WITH MODEL 630 POWER UNIT

7032 SOUTH 196th - KENT, WA 98032 - (253) 872-0141 / FAX (253) 872-8710



## - APPENDIX A - CAT C-18 ENGINE

### A-1D. Determining Cause Of Shutdown

**CAUTION:** If the engine has been shutdown by a safety device, don't start the engine and place it into service without having the cause of the shutdown investigated and corrected

#### Low Oil Pressure Checks

If the low oil pressure shutoff control has stopped the engine, make the following checks:

1. Check the water temperature gauge. Determine if the engine was overheated. Check for external water leaks.

**WARNING:** Beware of steam or scalding water. Do not attempt to loosen the radiator cap until the temperature gauge indicates the coolant has sufficiently cooled. Then, loosen the cap slowly.

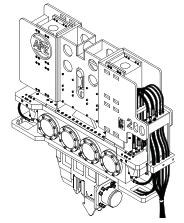
2. Check the oil level. Oil level must be between the ADD and FULL marks on the side of the dipstick stamped CHECK WITH ENGINE STOPPED.
3. If the oil level is below the ADD mark, check for oil spray and/or oil accumulations. If any are found, have the necessary repairs made. Before starting, add oil to the FULL mark. **Reset** the shutoff control.
4. Remove the load and start the engine at its slowest speed. Be prepared to shut the engine down manually.
5. Be alert for unusual sounds or noises. If the engine knocks, stop the engine immediately and call your engine dealer.
6. If the engine blows excessive black exhaust or has excessive crankcase blow-by, the engine may need reconditioning. Stop the engine and call your engine dealer.
7. If the engine runs satisfactorily, observe the oil pressure gauge. If satisfactory pressure is not indicated, shut the engine down; call your engine dealer.
8. If proper oil pressure is registered, check to see if the reset knob has moved to the run position. If the knob does not move, stop the engine. Check the shutoff control, the oil line, and the oil pressure gauge. Have necessary repairs made.
9. If the oil pressure gauge registers normal oil pressure, if the knob on the shutoff control moves to the run position, and if the engine operation is otherwise satisfactory, determine if the high water temperature shutoff may have shut down the engine.



# **OPERATION / MAINTENANCE MANUAL**

MODEL 200, 200T & 200-6 VIBRATORY DRIVER WITH MODEL 630 POWER UNIT

7032 SOUTH 196th - KENT, WA 98032 - (253) 872-0141 / FAX (253) 872-8710



## **- APPENDIX A - CAT C-18 ENGINE**

### **A-1D. Determining Cause Of Shutdown (Continued...)**

#### **High Water Temperature Checks-Engine Running**

1. Determine if the load was too great for the engine - Reduce the load and allow the engine to cool while running.
2. If pressure steam or water leaks are visible, remove the load and stop the engine. Have necessary repairs made.
3. Check for collapsing or deteriorated water hoses. Have repairs made.
4. Check for noisy water pump operation. Have necessary repairs made.
5. Refill the cooling system with a solution of water and permanent-type antifreeze if below freezing temperatures are expected; or with a solution of approved water and Corrosion Inhibitor. Follow the instructions on the container.

**WARNING: DO NOT remove the pressure cap on an overheated engine. The coolant is under pressure and relieving the pressure will cause the coolant to flash into steam.**

NOTE: If there is adequate coolant in the cooling system, gradual a l cooling is preferred by running the engine a half speed. This eliminates hot spots in the engine, and possible failure.

#### **High Water Temperature Checks-Engine Stopped and Cold**

1. Check coolant level. Determine if the coolant has proper antifreeze protection. A 50-50 solution of permanent-type antifreeze and approved water will give protection below -200F (-290C).
2. Check to be sure the raw water valve has been opened.
3. Check engine room vents and/or louvers. Be sure the engine is receiving sufficient air.
4. Be sure temperature regulators are operating at proper temperature range.
5. Inspect all water hoses carefully for collapsing, external and internal failures. Replace hoses as required.
6. Have the cooling system cleaned.

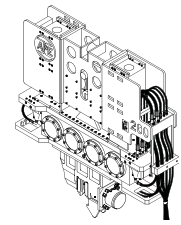
**CAUTION: If severe or prolonged overheating has occurred, contact your engine dealer to have your engine checked for possible damage.**



# **OPERATION / MAINTENANCE MANUAL**

MODEL 200, 200T & 200-6 VIBRATORY DRIVER WITH MODEL 630 POWER UNIT

7032 SOUTH 196th - KENT, WA 98032 - (253) 872-0141 / FAX (253) 872-8710



## **- APPENDIX A - CAT C-18 ENGINE**

### **A-2. MAINTENANCE RECOMMENDATIONS**

**CAUTION: Never add coolant to an overheated engine; allow the engine to cool first.**

#### **Cooling**

Check specific gravity of antifreeze solution frequently in cold weather to assure adequate protection. Coolant should be drained and replaced "Every 2000 Service Meter Units." With additions of Cooling System Inhibitor or the use of Coolant Conditioner Elements as recommended, the drain period can be extended to "Every 4000 Service Meter Units."

All water is corrosive at engine operating temperature. The cooling system should be protected with inhibitor at all times regardless of concentration of antifreeze. This can be done by maintaining a 3% concentration of liquid Cooling System Inhibitor or by using Coolant Conditioner Elements.

Never use both the liquid cooling system inhibitor and coolant elements at the same time.

Do not use Cooling System Inhibitor or Coolant Conditioner Elements with Dowtherm 209 Full-Fill Coolant.

Whenever draining and refilling cooling system, always recheck the coolant level when the engine reaches normal operating temperature.

Filling at over 5 U.S. gallons (19 liters) per minute can cause air pockets in the cooling system.

Premix antifreeze solution to provide protection to the lowest expected ambient temperature. Pure undiluted antifreeze will freeze at -100F (-23,C).

Operate with a thermostat in the cooling system all year-round. Cooling system problems can arise without a thermostat.

#### **Electrical**

**CAUTION: When using jumper cables to start the engine, be sure to connect in parallel: POSITIVE (+) to POSITIVE (+) and NEGATIVE (-) to NEGATIVE**

#### **Scheduled Oil Sampling**

Use scheduled Oil sampling to monitor the engine's condition and maintenance requirements. Each oil sample should be taken when the oil is hot, and well mixed, to insure a sample which is representative of the oil in the compartment.

Consult your engine dealer for complete information, and assistance in establishing a Scheduled Oil Sampling program for your equipment.

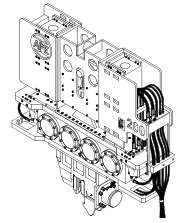




# **OPERATION / MAINTENANCE MANUAL**

MODEL 200, 200T & 200-6 VIBRATORY DRIVER WITH MODEL 630 POWER UNIT

7032 SOUTH 196th - KENT, WA 98032 - (253) 872-0141 / FAX (253) 872-8710



## **- APPENDIX A -** **CAT C-18 ENGINE**

### **A-2. MAINTENANCE RECOMMENDATIONS (Continued...)**

#### **Fuel**

**CAUTION:** Fill fuel tank at the end of each day of operation to drive out moisture laden air and to prevent condensation. Do not fill the tank to the brim. The fuel expands when it gets warm and may overflow.

Water and sediment should be drained from the fuel tank at the start of each shift or after the fuel tank has been filled and allowed to stand for 5 to 10 minutes.

Drain fuel tank of moisture and sediment as required by prevailing conditions.

After changing fuel filters, always bleed fuel system to remove air bubbles from system.

#### **Air intake**

Service air cleaners when RED band in indicator locks in visible position.

### **A-2A. LUBRICATION SPECIFICATIONS**

#### **Crankcase Lubricating Oils**

Use oils which meet Engine Service Classification (MIL-L-2104D) or CD/TO-2. These are additive-type oils that have been approved for use in Diesel Engines.

Consult the "EMA Lubricating Oils Data Book," Form SEBU5939, for a listing of CD oil brands.

The proper SAE grade of oil to select is determined by the ambient temperature at which the engine is started and the maximum ambient temperature in which the engine will be operating.

To determine if the oil in the crankcase will flow in cold weather, remove the oil dipstick before starting. If the oil will flow off, the oil is fluid enough to circulate properly.

#### **Lubricating Grease**

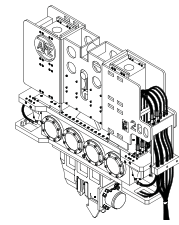
Use Multipurpose-type Grease (MPGM) which contains 3-5% molybdenum disulfide conforming to MIL-M-7866, and a suitable corrosion inhibitor. NLGI No.2 Grade is suitable for most temperatures. Use NLGI No. 0 or No. 1 Grade for extremely low temperatures.



# **OPERATION / MAINTENANCE MANUAL**

MODEL 200, 200T & 200-6 VIBRATORY DRIVER WITH MODEL 630 POWER UNIT

7032 SOUTH 196th - KENT, WA 98032 - (253) 872-0141 / FAX (253) 872-8710



## **- APPENDIX A -** **CAT C-18 ENGINE**

### **A-2. MAINTENANCE RECOMMENDATIONS (Continued...)**

#### **A-2B. FUEL SPECIFICATIONS**

No. 2 fuel oil and No. 2D diesel fuel are recommended for use in Diesel Engines. In extreme cold temperatures use No. 1 fuel oil or No.1 D diesel fuel.

In selecting a fuel, note that distillate fuels are especially desirable because the fuel is heated to a vaporous state and condensed, thus eliminating all sediment and residue.

#### **A-2C. COOLANT SPECIFICATIONS**

The anti-freeze coolant to be used should be CAT 8C-3684 mixed 50/50 with water. The water used in the jacket water cooling system should be clean, and as free as possible from scale forming minerals or corrosive chemicals. Artificially softened water should not be used. Treating the water with Coolant Inhibitor, or equivalent will help prevent the formation of rust and pitting. It will also retard, and in some cases completely eliminate, mineral deposits in the engine.

The most efficient and satisfactory corrosion protection for the cooling system is to maintain proper level of coolant inhibitor and antifreeze solution. The use of auxiliary water filters is not recommended.

During freezing weather use the proper permanent type antifreeze and water solution to prevent freezing.

Before placing the engine in operation, make sure a 3% concentration of Corrosion Inhibitor has been added to the cooling system. This 3% concentration must be maintained in cooling systems which are filled with water and systems protected with ethylene glycol antifreeze mixture, regardless of antifreeze concentration.

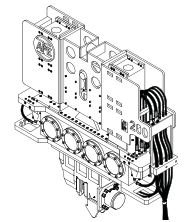
**WARNING: Inhibitors contain alkali. Avoid contact with eyes. To prevent personal injury, avoid pro-longed or repeated contact with skin.**



# OPERATION / MAINTENANCE MANUAL

MODEL 200, 200T & 200-6 VIBRATORY DRIVER WITH MODEL 630 POWER UNIT

7032 SOUTH 196th - KENT, WA 98032 - (253) 872-0141 / FAX (253) 872-8710



## - APPENDIX A - CAT C-18 ENGINE

### A-2. MAINTENANCE RECOMMENDATIONS (Continued...)

#### A-2D. LUBRICATION AND MAINTENANCE

The LUBRICATION AND MAINTENANCE CHART lists all serviceable items commonly ordered on this engine. The maintenance tune intervals are expressed in "Operating Hours".

Daily	Weekly	250 Hours or 6 months	1500 Hours or 1 Year	6000 Hours or 2 Years	6000 Hours or 3 Years
<ul style="list-style-type: none"> <li>● Check operator's report</li> <li>● Check and bring to correct level               <ul style="list-style-type: none"> <li>- Engine Oil</li> <li>- Coolant</li> </ul> </li> <li>● Visually inspect fan.</li> <li>● Visually inspect engine for damage, leaks, loose or frayed belts and correct or record for future action.</li> <li>● Drain fuel-water separator.</li> </ul>	<p><b>Repeat Daily Check</b></p> <ul style="list-style-type: none"> <li>● Check air intake system for wear points or damage to piping, loose clamps, and leaks.</li> <li>● Check air cleaner restriction.</li> <li>● Check and clean air cleaner element.</li> <li>● Drain moisture from air tanks.</li> </ul>	<p><b>Repeat Daily and Weekly Check</b></p> <ul style="list-style-type: none"> <li>● Change Lubricating Oil.</li> <li>● Change Lubricating Oil Filters.</li> <li>● Change Fuel Filter.</li> <li>● Change Coolant Filter.</li> <li>● Clean Crankcase Breather.</li> <li>● Check engine coolant concentration level. Add make-up if required.</li> <li>● Replace final Fuel Filter/Clean primary Fuel Filter. Drain water from fuel tank.</li> <li>● Inspect/Replace Alternator, Fan and Accessory Drive Belts.</li> <li>● Inspect/Replace Hoses and Clamps.</li> <li>● Lubricate Fan Drive Bearings.</li> <li>● Clean/Check Battery electrolyte level.</li> </ul>	<p><b>Repeat Previous Intervals</b></p> <ul style="list-style-type: none"> <li>● Adjust valves and injectors.</li> <li>● Steam clean engine.</li> <li>● Check torque on turbo-charger mounting nuts</li> <li>● Check torque on engine mounting bolts. Replace hoses as required.</li> <li>● Check/Adjust engine valve lash.</li> <li>● Check/Adjust low idle speed.</li> <li>● Test/Exchange fuel injection nozzles.</li> <li>● Clean cooling system. (Internal)</li> <li>● Inspect/Rebuild Alternator.</li> </ul>	<p><b>Repeat Previous Intervals</b></p> <ul style="list-style-type: none"> <li>● Clean cooling system and change coolant and anti-freeze.</li> <li>● Inspect temperature regulator.</li> <li>● Inspect/Rebuild turbocharger.</li> <li>● Inspect/Rebuild starter.</li> <li>● Check and adjust clutch.</li> </ul>	<p><b>Repeat Previous Intervals Which Are Due</b></p> <ul style="list-style-type: none"> <li>● Clean and calibrate the following: (Rebuild or exchange if required.)               <ul style="list-style-type: none"> <li>- Injectors.</li> <li>- Fuel pump.</li> <li>- Air compressor.</li> <li>- Fan clutch.</li> <li>- Water pump.</li> <li>- Fan hub.</li> <li>- Fan idler pulley assembly.</li> <li>- Vibration damper.</li> </ul> </li> </ul>

Follow the manufacturer's recommended maintenance procedures for the starter, alternator, generator, batteries, electrical components, engine brake, exhaust brake, air compressor, freon compressor, and fan clutch.

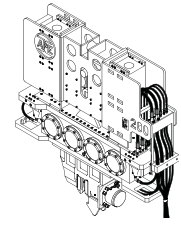
At each scheduled maintenance interval, perform all previous maintenance checks which are due for scheduled maintenance.



# **OPERATION / MAINTENANCE MANUAL**

MODEL 200, 200T & 200-6 VIBRATORY DRIVER WITH MODEL 630 POWER UNIT

7032 SOUTH 196th - KENT, WA 98032 - (253) 872-0141 / FAX (253) 872-8710



## **- APPENDIX A - CAT C-18 ENGINE**

### **A-2E. ELECTRICAL SYSTEM**

The following topics describe care and maintenance of the electrical system components. These components functioning together produce the energy needed for operating the electrical equipment on the engine and each is dependent upon the others for satisfactory operation. In the event of failure or improper operation, it is essential to check the entire electrical system as a defect in one component can cause damage to another. Many electrical system problems can be traced to loose or corroded connections. Keep connections tight and make sure the wiring insulation is in satisfactory condition. Most of the electrical system testing can be performed while the components are on the engine. It should be remembered, if a malfunction is found on test, the component must be removed for further testing, repair or replacement.

#### **Battery**

Every 250 hours check the electrolyte level of each cell and the general condition of the battery. Maintain the electrolyte level to the base of each vent well. The make-up water must be one of the following (in order of preference):

1. Distilled water.
2. Odorless, tasteless drinking water-
3. Iron free water.

**WARNING: Never add acid or electrolyte.**

#### **Cleaning Battery**

Mix a weak solution of baking soda and water. Apply the solution with a soft bristle brush. Be careful not to get cleaning solution into the battery. Thoroughly rinse the battery and battery tray with clean water. Apply grease to battery cable clamps and terminals and to all threads.

#### **Installing Battery**

1. Be sure the battery tray is clean and free of foreign objects.
2. Be sure terminal posts and cable clamps are clean.
3. Place the battery in the tray. Tighten the hold down clamps evenly until the battery is snug. Do not over tighten.
4. Connect the "hot" terminal first. Be sure the top of the cable terminal is pushed down even with the top of the terminal post. Tighten the clamp firmly.

**WARNING: Always connect the "hot" terminal first to minimize arcing. Otherwise injury or damage could result.**

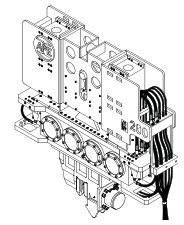
5. Connect the "grounded" terminal last. Be sure the top of the cable terminal is pushed down even with the top of the terminal post. Tighten the clamp firmly.
6. Apply a thin coating of grease over the cable clamps, terminals and hold down fasteners.



# OPERATION / MAINTENANCE MANUAL

MODEL 200, 200T & 200-6 VIBRATORY DRIVER WITH MODEL 630 POWER UNIT

7032 SOUTH 196th - KENT, WA 98032 - (253) 872-0141 / FAX (253) 872-8710



## - APPENDIX A - CAT C-18 ENGINE

### A-2E. ELECTRICAL SYSTEM (Continued...)

#### Charging the Battery

**WARNING:** Never smoke in the area where batteries are being charged. Hydrogen gas is given off at each vent cap during charging. Hydrogen mixed with air is highly explosive.

1. Connect positive charger clamp to positive battery terminal.
2. Connect negative charger clamp to negative battery terminal.
3. Connect charger power cord to proper outlet.
4. Allow battery to charge slowly.

**CAUTION:** If battery is charged too rapidly, the battery will be damaged.

5. After the battery is charged, disconnect charger power cord from outlet; remove charger clamp from negative battery terminal; remove charger clamp from positive battery terminal.

### A-3. Engine Troubleshooting.

#### -TROUBLESHOOTING INDEX-

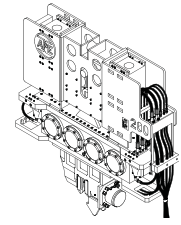
ITEM	PROBLEM	ITEM	PROBLEM
1.	Engine Fails to Start	16.	Valve Lash Close-up
2.	Misfiring	17.	Premature Engine Wear
3.	Stalls at Low Speed	18.	Coolant in Engine Lubricating Oil
4.	Erratic Engine Speed	19.	Excessive Black or Gray Smoke
5.	Low Power	20.	Excessive White or Blue Smoke
6.	Excessive Vibration	21.	Low Engine Oil Pressure
7.	Heavy Combustion Knock	22.	High Lubricating Oil Consumption
8.	Valve Train Clicking Knock	23.	Abnormal Engine Coolant Temperature
9.	Oil in Coolant	24.	Starting Motor Fails to Crank
10.	Mechanical Knock	25.	Alternator Fails to Charge
11.	Excessive Fuel Consumption	26.	Alternator Charging Rate Low or Unsteady
12.	Loud Valve Train Noise	27.	Alternator Charging Rate High
13.	Excessive Valve Lash	28.	Alternator Noisy
14.	Valve Spring Retainer Free		
15.	Slobber		



# OPERATION / MAINTENANCE MANUAL

MODEL 200, 200T & 200-6 VIBRATORY DRIVER WITH MODEL 630 POWER UNIT

7032 SOUTH 196th - KENT, WA 98032 - (253) 872-0141 / FAX (253) 872-8710



## - APPENDIX A - CAT C-18 ENGINE

### A-3. Engine Troubleshooting. (Continued...)

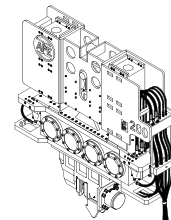
Possible Causes	Remedy
<b>1. ENGINE FAILS TO START</b>	
No Fuel to Engine	Check for empty fuel tank, plugged fuel tank connections, obstructed or kinked fuel suction lines, fuel transfer pump failure, or plugged fuel filters.
Shutoff Solenoid Sticking*	Solenoid must be energized to shut off engine. Actuate the control that operates the shutoff solenoid and listen for a clicking sound. If clicking sound is not evident and engine will not start, remove the solenoid. Again try to start the engine. If the engine starts, the solenoid is bad. Replace the solenoid.
Fuel Transfer Pump	At cranking speed, the fuel transfer pump should supply fuel to the engine at 3 PSI (20 kPa). If fuel pressure is less than 3 PSI (20 kPa), replace the fuel filter. Check for air in fuel system, sticking, binding or defective fuel bypass valve. If pressure is still low, replace the fuel transfer pump.
Engine Improperly Timed	See your authorized dealer.
Glow Plug Failure	Check glow plugs.
Automatic and Safety Shutoff Controls	Check shutoff controls to ensure they are set properly. See Starting Procedures.
*Optional Equipment	
<b>2. MISFIRING</b>	
Defective Fuel Injection Nozzle or Fuel Pump	Run the engine at the speed where the defect is most pronounced. Momentarily loosen the fuel line nut on the injection pump to "cut out" that cylinder. Check each cylinder in this manner. If one is found where loosening makes no difference in irregular operation, the pump and nozzle for only that cylinder need be treated.
Improper Valve Lash	Set to specified clearance.
Incorrect Fuel Injection Timing	See your authorized dealer.
Low Fuel Supply Pressure	Check fuel supply line for leaks or kinks, air in fuel system, sticking, binding, or defective fuel bypass valve. Replace fuel filter. Check fuel pressure. Fuel transfer pump should supply fuel at 20 to 30 PSI (1.4 to 2.1 kg/CM <sup>2</sup> ) to the engine when the engine is fully loaded.
Broken or Leaking High Pressure Fuel Line	Replace the line.
Air in Fuel System	Find source of air entry and correct. Bleed system.
Bent or Broken Push Rod	Replace push rod.



# OPERATION / MAINTENANCE MANUAL

MODEL 200, 200T & 200-6 VIBRATORY DRIVER WITH MODEL 630 POWER UNIT

7032 SOUTH 196th - KENT, WA 98032 - (253) 872-0141 / FAX (253) 872-8710



## - APPENDIX A - CAT C-18 ENGINE

### A-3. Engine Troubleshooting. (Continued...)

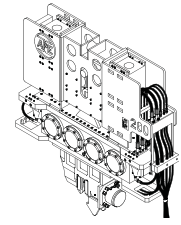
Possible Causes	Remedy
<b>4. ERRATIC ENGINE SPEED</b>	
Governor Control Linkage	Adjust external linkage to obtain sufficient travel. Replace if damaged, bent, or linkage is too short.
Governor Failure	Look for damaged or broken springs, linkage, or other components. Determine if the rack can be moved manually. If any distress is noted in any of these components, replace as necessary.*
<b>5. LOW POWER</b>	
Fuel Nozzle Failure	Run the engine at the speed where the defect is most pronounced. Momentarily loosen the fuel line nut on the injection pump to "cut out" that cylinder. Check each cylinder in this manner. If one is found where loosening makes no difference in irregular operation, the pump and nozzle for only that cylinder need be tested.
Poor Quality Fuel	Drain, clean and bleed fuel system. Replace fuel filter. Fill fuel tank with proper grade of fuel.
Turbocharger Carboned or Otherwise Dragging	Inspect and repair or replace turbo charger as necessary.*
Leaks in Air Induction System	Check inlet manifold pressure. Check air cleaner for restriction.
Incorrect Fuel Injection Timing	See your authorized dealer.
Excessive Valve Lash	Set to specified clearance.
Low Fuel Supply Pressure	Check fuel supply line for leaks or kinks, air in fuel system, sticking, binding or defective fuel bypass valve. Replace fuel filter. Check fuel pressure. Fuel transfer pump should supply fuel to 20 to 30 PSI(1.4 to 2.1kg/CM <sup>2</sup> ) to the engine when the engine is fully loaded.
<b>6. EXCESSIVE VIBRATION</b>	
Loose, Worn or Defective Engine Mounts as necessary.	Tighten all mounting bolts securely. Replace components
Loose Pulley and Damper	Re tighten.
Loose or Worn Coupling on Driven Equipment	Inspect, align and tighten coupling to driven equipment.
Defective Damper or Pulley	Replace damper or pulley.
Misfiring	See ITEM 2.



# OPERATION / MAINTENANCE MANUAL

MODEL 200, 200T & 200-6 VIBRATORY DRIVER WITH MODEL 630 POWER UNIT

7032 SOUTH 196th - KENT, WA 98032 - (253) 872-0141 / FAX (253) 872-8710



## - APPENDIX A - CAT C-18 ENGINE

### A-3. Engine Troubleshooting. (Continued...)

#### Possible Causes

#### Remedy

#### 7. HEAVY COMBUSTION KNOCK

Air in Fuel System	Bleed air from system.
Defective Fuel Injection Pump Plunger and Barrel Assembly	Replace.*
Defective Fuel Injection Nozzle	Replace.
Incorrect Fuel Injection Timing	See your authorized dealer.*

#### 8. VALVE TRAIN CLICKING NOISE

Excessive Valve Lash	Set to specified clearance.
Broken Valve Spring(s)	Replace valve spring(s) and all other damaged components.*
Insufficient Lubrication	Check lubrication in valve compartment. Should be very wet at all speeds. Oil passages should be cleaned, especially those leading to the cylinder head.

#### 9. OIL IN COOLANT

Failed Oil Cooler Core	Replace oil cooler core.
Failed Head or Spacer Plate Gaskets	Replace head and spacer plate gaskets.
Cracked or Defective Cylinder Block	Replace cylinder block.*
Cracked or Defective Head	Replace cylinder head.

#### 10. MECHANICAL KNOCK

Engine Connecting Rod Bearing	Replace the bearing. Check the connecting rod and Failure crankshaft. Replace if necessary.*
Main Bearing Failure	Replace bearings.*
Damaged Timing Gear Train	Replace components as necessary.*
Broken Crankshaft	Replace crankshaft.*
Fuel Dilution of Crankcase Oil	Correct fuel leakage into crankcase oil.

\*Authorized dealers are equipped with the necessary tools and personnel familiar with disassembly procedures to perform these services.

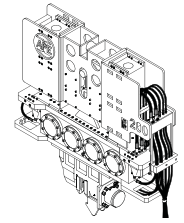




# OPERATION / MAINTENANCE MANUAL

MODEL 200, 200T & 200-6 VIBRATORY DRIVER WITH MODEL 630 POWER UNIT

7032 SOUTH 196th - KENT, WA 98032 - (253) 872-0141 / FAX (253) 872-8710



## - APPENDIX A - CAT C-18 ENGINE

### A-3. Engine Troubleshooting. (Continued...)

#### Possible Causes

#### Remedy

#### 11. EXCESSIVE FUEL CONSUMPTION

Fuel System Leaks

Large changes in fuel consumption may result. Internal leaks will probably be accompanied by low engine oil pressure and increased oil level in the engine oil sump. Replace leaking components.

Fuel and Combustion Knock

Small but measurable increases in fuel consumption maybe the result of defective fuel nozzles, misfiring or factors contributing to loss of power. See ITEM 2 and ITEM 5.

Incorrect Fuel Injection Timing

See your authorized dealer.

#### 12. LOUD VALVE TRAIN NOISE

Bent or Broken Valves

Replace damaged parts.\*

Broken Camshaft

Replace all damaged parts. Clean engine thoroughly.

Broken or Severely Worn Valve Lifters

Replace camshaft and valve lifters. Check for sticking valves and bent valve stems. Clean engine thoroughly. Set valve lash to specified clearance.

#### 13. EXCESSIVE VALVE LASH

Severely Worn Cam Lobes

Check valve lash. Replace camshaft and followers. Clean engine thoroughly. Set valve lash to specified clearance.

Broken or Severely Worn Valve Lifters

Replace valve lifters. Check camshaft for wear. Check for sticking valves and bent valve stems. Clean engine thoroughly. Set valve lash to specified clearance.

Valve Tip Wear

Set valve lash to specified clearance. If wear is excessive, replace valve. Moderate Valve Lifter Face Wear Set valve lash to specified clearance. If wear is excessive, replace valve lifter.

Push Rod Wear

Set valve lash to specified clearance. If wear is excessive, replace push rod.

Rocker Arm Anvil Wear

Set valve lash to specified clearance. If wear is excessive, replace rocker arm.

Insufficient Lubrication

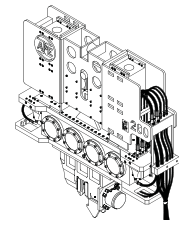
Check lubrication in valve should be very wet at high idle speeds, but only damp at low idle. Oil passages should be cleaned, especially those leading to the cylinder head.



# OPERATION / MAINTENANCE MANUAL

MODEL 200, 200T & 200-6 VIBRATORY DRIVER WITH MODEL 630 POWER UNIT

7032 SOUTH 196th - KENT, WA 98032 - (253) 872-0141 / FAX (253) 872-8710



## - APPENDIX A - CAT C-18 ENGINE

### A-3. Engine Troubleshooting. (Continued...)

Possible Causes	Remedy
<b>14. VALVE SPRING RETAINER FREE</b>	
Broken Keepers	Extensive engine damage may result from dropped valve. Replace all damaged parts.*
Broken Valve Spring	Replace valve spring.*
Broken Valve	Replace valve and any other damaged parts.*
<b>15. SLOBBER</b>	
Excessive Valve Guide Wear	Recondition cylinder head assembly.*
Excessive Lubricating Oil in Valve Compartment	Check rocker arm shaft and plugs to assure that they are in place.
Worn Piston Rings and/or Liners	Inspect and replace components as necessary.*
<b>16. VALVE LASH CLOSE-UP</b>	
Valve Face and/or Seat Wear	Adjust valves to specified clearance. Recondition cylinder head.
<b>17. PREMATURE ENGINE WEAR</b>	
Intake Piping Failure (Air Cleaner)	Inspect all gaskets and piping for leaks. Repair all leaks.
Excessive Fuel Dilution of Lubricating Oil	Replace leaking components. This will probably be accompanied by high fuel consumption and low engine oil pressure. Tighten fuel injection line fittings under valve cover.
Dirt in Lubricating Oil	Locate and correct source of dirt entry, Change lubricating oil. Change oil filter.
<b>18. COOLANT IN ENGINE LUBRICATING OIL</b>	
Oil Cooler Failure	Replace oil cooler core.
Cylinder Head Gasket Failure	Replace gasket. Maintain proper torque on cylinder head bolts.
Cracked or Defective Cylinder Head	Replace cylinder head.*
Cracked or Defective Cylinder Block	Replace cylinder block.*

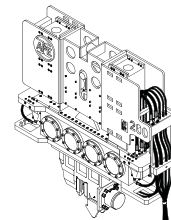
\*Authorized dealers are equipped with the necessary tools and personnel familiar with disassembly and assembly procedures to perform these serviced.



# OPERATION / MAINTENANCE MANUAL

MODEL 200, 200T & 200-6 VIBRATORY DRIVER WITH MODEL 630 POWER UNIT

7032 SOUTH 196th - KENT, WA 98032 - (253) 872-0141 / FAX (253) 872-8710



## - APPENDIX A - CAT C-18 ENGINE

### A-3. Engine Troubleshooting. (Continued...)

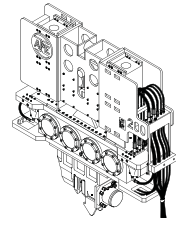
Possible Causes	Remedy
<b>18. COOLANT IN ENGINE LUBRICATING OIL (Cont'd)</b>	
Cylinder Liner Seal Leaking	Replace seals.*
Cracked or Defective Cylinder Liners	Replace cylinder liners.'
<b>19. EXCESSIVE BLACK OR GRAY SMOKE</b>	
Insufficient Combustion Air	Check air cleaner for restriction. Check inlet manifold pressure. Inspect turbocharger for proper operation.
Fuel Nozzle Plugged or Leaking	Replace nozzle.
Incorrect Fuel Injection Timing	See your authorized dealer.
Fuel Ratio Control Improperly Adjusted	Adjust fuel ratio control.*
<b>20. EXCESSIVE WHITE OR BLUE SMOKE</b>	
Valve Guides Worn	Recondition cylinder head assembly.*
Piston Rings Worn, Stuck or Broken	Replace.*
High Crankcase Oil Level	Avoid overfilling. Determine cause and drain excess oil.
Misfiring	See ITEM 2.
Fuel Injection Pump Timing Wrong	See your authorized dealer.
Air in Fuel System	Bleed fuel system.
<b>21. LOW ENGINE OIL PRESSURE</b>	
Engine Oil Diluted with Fuel Oil	Check lip-type seal on fuel transfer pump drive shaft. Drain crankcase and refill with clean lubricant.
Excessive Crankshaft Bearing Clearance	Replace bearings and/or crankshaft.* Check oil filter operation.
Excessive Timing Gear Bearing Clearances	Inspect bearings and replace components as necessary.
Excessive Rocker Arm Bore or Rocker Arm Shaft Wear	Check lubrication. Replace components as necessary.
Defective Oil Pump	Repair or replace.*
Defective Suction Bell	Replace.



# OPERATION / MAINTENANCE MANUAL

MODEL 200, 200T & 200-6 VIBRATORY DRIVER WITH MODEL 630 POWER UNIT

7032 SOUTH 196th - KENT, WA 98032 - (253) 872-0141 / FAX (253) 872-8710



## - APPENDIX A - CAT C-18 ENGINE

### A-3. Engine Troubleshooting. (Continued...)

Possible Causes	Remedy
<b>21. LOW ENGINE OIL PRESSURE (Cont'd)</b>	
Clogged Oil Filter or Cooler	Repair or replace as necessary.
Oil Pump Relief Valve Stuck	Clean valve and housing. Replace if necessary.
<b>22. HIGH LUBRICATING OIL CONSUMPTION</b>	
Oil Leaks	Replace gaskets or seals and tighten all connections.
Excessive Oil to Intake	See ITEM 15. Valve Guides.
Excessive Valve Guide Wear	See ITEM 15.
Crankcase Oil Level Too High	Avoid overfilling. Determine cause and drain excess oil.
High Oil Temperature	Check oil cooler bypass valve. Replace if defective. Clean oil cooler core.
Worn Piston Rings and/or Liner	Replace components as necessary.*
<b>23. ABNORMAL ENGINE COOLANT TEMPERATURE</b>	
Combustion Gases in Coolant	Determine point at which gases enter the system. Repair or replace components as necessary.
Defective Water Temperature Regulator or Temperature Gauge	Check temperature regulator for proper opening temperature and correct installation. Check temperature gauge. Replace if necessary.
Coolant Level Low	Determine cause-replace leaking gaskets and hoses. Tighten connections. Add coolant.
Air Flow Through Radiator Restricted	Remove all debris from outer surface of radiator.
Defective Water Pump	Check water pump impeller. Repair water pump as necessary.
Radiator Small for Engine Application	Install correct size radiator.
Fan Improperly Positioned in Shroud or Not Shrouded	Position fan correctly.*

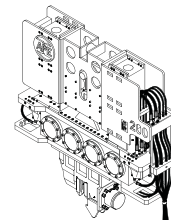
\*Authorized dealers are equipped with the necessary tools and personnel familiar with disassembly and assembly procedures to perform these serviced.



# OPERATION / MAINTENANCE MANUAL

MODEL 200, 200T & 200-6 VIBRATORY DRIVER WITH MODEL 630 POWER UNIT

7032 SOUTH 196th - KENT, WA 98032 - (253) 872-0141 / FAX (253) 872-8710



## - APPENDIX A - CAT C-18 ENGINE

### A-3. Engine Troubleshooting. (Continued...)

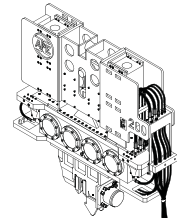
Possible Causes	Remedy
<b>23. ABNORMAL ENGINE COOLANT TEMPERATURE</b>	
Incorrect Fuel Injection Timing	See your authorized dealer.
Incorrect Water Piping Connections from Engine to Radiator	Check shunt line (if equipped) and vent line for correct installation.
<b>24. STARTING MOTOR FAILS TO CRANK</b>	
Low Output from Battery	Check battery and charge or replace.
Defective Wiring or Switch	Repair or replace.
Defective Solenoid	Replace.
Defective Starting Motor	Repair.
<b>25. ALTERNATOR FAILS TO CHARGE</b>	
Drive Belt Loose	Adjust belt.
Open or High Resistance in Charging or Ground Return Circuits or Battery Connections	Inspect all cables and connectors. Clean, re tighten or replace defective parts.
Excessively Worn, Open or Defective Brushes	Replace brush assembly.*
Open Rotor Field Coil	Replace rotor assembly.*
<b>26. ALTERNATOR CHARGING RATE LOW OR UNSTEADY</b>	
Drive Belt Loose	Adjust belt.
Intermittent or High Resistance in Charging or Ground Return Circuits or Battery Connections	Inspect all cables and connectors. Clean, re tighten or replace defective parts.
Excessively Worn, Sticky, or Defective Brushes	Replace brush assembly.*
Faulty Regulator	Replace regulator.*
Shorted or Open Rectifier Diodes	Replace defective rectifier diode assembly in alternator.*
Grounded or Shorted Rotor	Replace rotor assembly.*



# **OPERATION / MAINTENANCE MANUAL**

MODEL 200, 200T & 200-6 VIBRATORY DRIVER WITH MODEL 630 POWER UNIT

7032 SOUTH 196th - KENT, WA 98032 - (253) 872-0141 / FAX (253) 872-8710



## **- APPENDIX A - CAT C-18 ENGINE**

### **A-3. Engine Troubleshooting. (Continued...)**

<b>Possible Causes</b>	<b>Remedy</b>
<b>27. ALTERNATOR CHARGING RATE HIGH</b>	
Loose Connections	Tighten connections to alternator and regulator.
Defective Regulator	Replace regulator.
<b>28. ALTERNATOR NOISY</b>	
Defective Drive Belt	Replace belt.
Misaligned Belt or Pulley	Align drive pulley, alternator pulley and belt.
Loose Pulley	Tighten pulley nut. If keyway is worn, install a new pulley.
Worn Bearings	Replace bearings.
Shorted Rectifiers in Alternator	Replace diode assembly.*
Armature or Rotor Shaft Bent	Replace component.*

\*Authorized dealers are equipped with the necessary tools and personnel familiar with disassembly and assembly procedures to perform these serviced.