

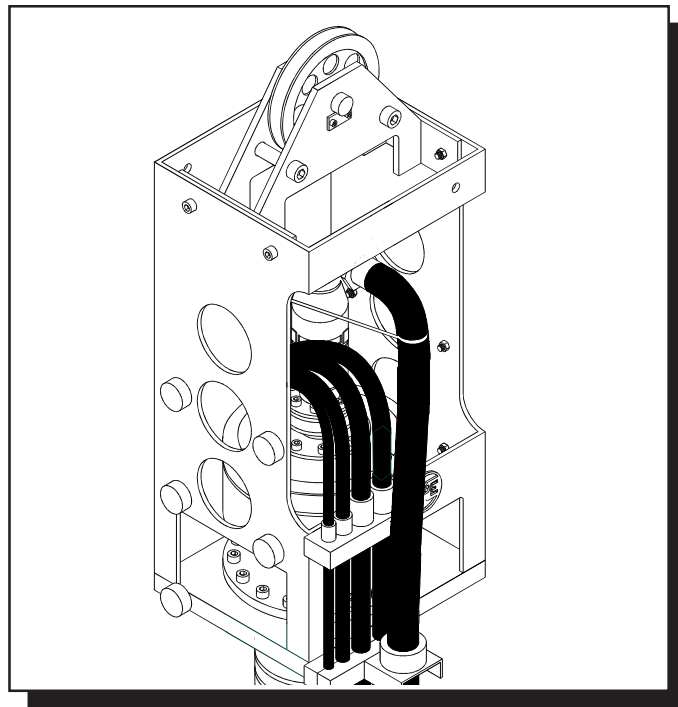

# OPERATION AND MAINTENANCE MANUAL



SERIAL NUMBER:

**MODEL 50 AUGER WITH  
MODEL 240 POWER UNIT**





# **OPERATION / MAINTENANCE MANUAL**

MODEL 50 AUGER WITH MODEL 240 POWER UNIT

7032 SOUTH 196th - KENT, WA. 98032 - (206) 872-0141 / FAX (206) 872-8710

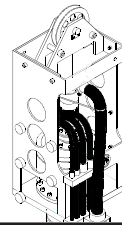

## **Preface**

### **General**

This manual covers the **Model 50 Auger and the Model 240 Power Unit**. The data provided in this manual gives the necessary information to operate and maintain APE equipment. The listed procedures are to be performed by qualified personnel who have an understanding of the equipment and who follow all safety precautions.

### **Guide to Using the Manual**

1. Refer to the Table of Contents for the page location of applicable sections.
2. All weights and measurements in this manual are in both English and Metric units.
3. The manual will be revised as necessary to reflect current information.

### **Abbreviations**

The following are abbreviations used within this manual.

- lbs.** = Pounds
- psi.** = Pounds per Square Inch
- hp.** = Horse Power
- gpm.** = Gallons Per Minute
- rpm.** = Revolutions Per Minute
- hyd.** = Hydraulic
- NPT.** = National Pipe Thread



# OPERATION / MAINTENANCE MANUAL

MODEL 50 AUGER WITH MODEL 240 POWER UNIT

7032 SOUTH 196th - KENT, WA. 98032 - (206) 872-0141 / FAX (206) 872-8710

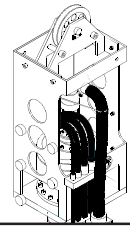

## Table of Contents

	Page
Revision Record .....	i
Preface .....	ii
Table of Contents .....	iii
Safety Precautions .....	v
Illustration List .....	vi
Table List .....	vi
Warranty .....	vii
<b>I. GENERAL INFORMATION .....</b>	<b>1-1</b>
I-1. Machine Features .....	1-1
I-2. Machine Specifications .....	1-2
A. Model 50 Auger .....	1-2
B. Model 240 Power Unit .....	1-2
I-3. General Description of 50 Auger .....	1-3
A. Basic Working Principles .....	1-4
I-4. General Description of Model 240 Power Unit .....	1-5
<b>II. MAJOR COMPONENT DEFINITION .....</b>	<b>2-1</b>
II-1. Component Identification .....	2-1
II-2. Model 240 Power Unit Skid Identification .....	2-3
II-3. Quick Disconnect Couplings .....	2-4
II-4. Tool Set Identification .....	2-5
II-5. Upper Shaft Coupling Assembly .....	2-6
<b>III. LOADING AND UNLOADING .....</b>	<b>3-1</b>
III-1. Model 50 Auger .....	3-1
III-2. Model 240 Power Unit .....	3-1
III-3. What to do if damaged during shipment .....	3-1
<b>IV. PREPARATION AND OPERATION .....</b>	<b>4-1</b>
IV-1. Rigging of The Auger .....	4-1
IV-2. Filling Auger Pressure Hoses .....	4-1
IV-3. Shutdown Procedures .....	4-1
IV-4. Plumbing the Auger Hoses to the Power Unit .....	4-2
IV-5. Operation of the Remote Control Pendant .....	4-3
<b>V. MAINTENANCE .....</b>	<b>5-1</b>
V-1. Daily Maintenance Required Prior to Operation .....	5-1
V-2. Checklist After Power Unit Engine Has Started .....	5-1
V-3. Coupling Maintenance .....	5-2
V-4. Gearbox Maintenance .....	5-3
V-5. Power Unit .....	5-4
A. Power Unit Filters, Fluid Types and Capacities .....	5-4
B. Hydraulic Fluid .....	5-5
C. Draining and Filling Hydraulic Fluid Tank .....	5-5
D. Cleaning Hydraulic Tank Suction Filter .....	5-5
E. Changing Hydraulic Return Filter Element .....	5-6
F. Steps to Remove Filter Element .....	5-6



# OPERATION / MAINTENANCE MANUAL

MODEL 50 AUGER WITH MODEL 240 POWER UNIT

7032 SOUTH 196th - KENT, WA. 98032 - (206) 872-0141 / FAX (206) 872-8710

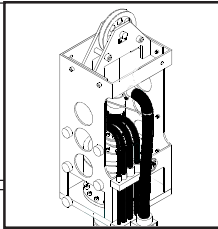

## Table of Contents (Continued...)

<b>VI. TROUBLESHOOTING: Model 50 Auger</b> .....	<b>6-1</b>
<b>VII. MODEL 240 POWER UNIT</b> .....	<b>7-1</b>
VII-1. Hydraulic Circuitry .....	7-1
A. Clamp Circuit .....	7-1
B. Drive Circuit .....	7-1
C. Return Filter .....	7-2
D. Heat Exchanger .....	7-2
E. Manual Pump .....	7-2
F. Hydraulic Oil Temperature .....	7-2
G. Hydraulic Components .....	7-2
H. Hydraulic Schematic .....	7-3
VII-2. Electrical Circuitry .....	7-4
A. Diesel Engine .....	7-4
B. Controls: Understanding How They Work .....	7-4
C. Preparing The Electrical System For Start-Up .....	7-7
D. Engine Safety Shut-Down Button Switch .....	7-7
E. Engine Safety Shut-Down (Three Causes Of Engine Shut-Down) .....	7-8
F. Electrical Schematic .....	7-9
VII-3. Remote Control Pendant .....	7-10
A. Remote Pendant Wiring Diagram .....	7-11
VII-4. Troubleshooting: Power Unit Electrical .....	7-12
A. Engine Oil Pressure Switch .....	7-12
B. Water Temperature Switch .....	7-12
C. Hydraulic Oil Level Switch .....	7-12
D. Oil Pressure Sending Unit (Cat Engines) .....	7-13
E. Oil Pressure Sending Unit (Cummins Engines) .....	7-13

## APPENDIX A - CUMMINS 6CT 8.3 ENGINE

A-1. ENGINE OPERATION INSTRUCTIONS .....	A-1
A. Pre-Start Inspection and Procedures .....	A-1
B. Starting The Engine .....	A-2
C. Engine Operation .....	A-3
D. Determining Cause of Shutdown .....	A-7
A-2. MAINTENANCE RECOMMENDATIONS .....	A-9
A. Lubrication Specifications .....	A-10
B. Fuel Specifications .....	A-11
C. Coolant Specifications .....	A-11
D. Lubrication and Maintenance .....	A-12
E. Electrical System .....	A-13
A-3. ENGINE TROUBLESHOOTING .....	A-14
Drive shaft output flange details .....	A-24/25



# **OPERATION / MAINTENANCE MANUAL**

**MODEL 50 AUGER WITH MODEL 240 POWER UNIT**

**7032 SOUTH 196th - KENT, WA. 98032 - (206) 872-0141 / FAX (206) 872-8710**

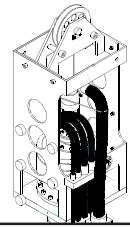

## **Safety Precautions**

(This list of precautions must be followed at all times to ensure personal & equipment safety).

1. Read this manual from beginning to end before operating or working on this machine.
2. When operating in a closed area, pipe exhaust fumes outside. (**WARNING:** Breathing exhaust fumes can cause serious injury and even death).
3. When servicing batteries, avoid any type of spark or open flame. Batteries generate explosive gases during charging. There must be proper ventilation when charging batteries.
4. Never adjust or repair the unit while it is in operation.
5. Make sure the Control Pendant is in the "**OFF**" position before starting the unit.
6. Remove all tools and electrical cords before starting the unit.
7. Keep oily rags away from the exhaust system.
8. Never store flammable liquids near the engine.
9. Never stand under drill at any time and keep your eyes on the drill when it is in operation. Keep a look out for loose bolts or leaking hydraulic lines.
10. Avoid pulling on hose quick disconnect fittings. Move power unit closer to work if hoses cannot reach. Do not use hoses as a tow line to tug the power unit! If a hose fails at the hydraulic couplers then it is a result of "hose tugging by the pile crew".
11. Avoid kinks in the hoses. Kinks will cut the hose safety factor by 50 percent.
12. Always wear eye and ear protection.
13. Avoid standing downwind of augered holes. Dirt and other matter may become airborne and fall into the unprotected eye.
14. Always wear a hardhat, gloves and safety shoes.
15. Do not perform maintenance on auger while power unit is on.
16. Look out for falling mud and debris from auger flighting. Never stand near drill while it is doing work.
17. Do not truck power unit with quick disconnect caps and plugs screwed on to fittings unless the caps and plugs have wire rope safety lines attached. Store in storage box under control panel.



# OPERATION / MAINTENANCE MANUAL

MODEL 50 AUGER WITH MODEL 240 POWER UNIT

7032 SOUTH 196th - KENT, WA. 98032 - (206) 872-0141 / FAX (206) 872-8710

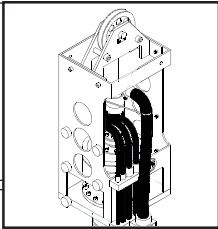

## Illustration List

<b>Figure</b>	<b>Title</b>	<b>Page</b>
1-A.	Machine Features .....	1-1
1-B.	General Description of 50 Auger .....	1-3
1-C.	General Description of Model 240 Power Unit .....	1-8
2-A.	Component Identification .....	2-1
2-B.	Model 240 Power Unit Skid Identification .....	2-3
2-C.	Quick Disconnect Coupling Identification .....	2-4
2-D.	Tool Set Identification.....	2-5
2-E.	Upper Shaft Coupling Assembly .....	2-6
4-A.	Power Unit Coupler Layout.....	4-2
7-A.	Power Unit Hydraulic Schematic .....	7-3
7-B.	Power Unit Electrical Schematic .....	7-9
7-C.	Remote Control Pendant .....	7-10
7-D.	Remote Control Pendant Wiring Diagram .....	7-11

## Table List

<b>Table</b>	<b>Title</b>	<b>Page</b>
1-A.	Machine Specifications - Model 50 Auger .....	1-2
1-B.	Machine Specifications - Model 240 Power Unit .....	1-2
2-A.	Component Identification .....	2-2
2-B.	Model 240 Power Unit Skid Identification .....	2-3
2-C.	Tool Set Identification .....	2-4
2-D.	Quick Disconnect Coupling Identification .....	2-5
2-E.	Upper Shaft Coupling Assembly .....	2-7
5-A.	Power Unit - Filters, Fluid Types and Capacities .....	5-3
6-A.	Trouble-Shooting .....	6-1
7-A.	Hydraulic Components .....	7-2



# **OPERATION / MAINTENANCE MANUAL**

MODEL 50 AUGER WITH MODEL 240 POWER UNIT

7032 SOUTH 196th - KENT, WA. 98032 - (206) 872-0141 / FAX (206) 872-8710

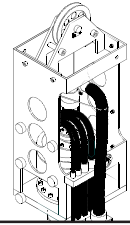

## **Warranty**

### **American Piledriving Equipment, Inc. STANDARD WARRANTY**

American Piledriving Equipment, Inc. (APE) warrants new products sold by it to be free from defects in material or workmanship for a period of one year after the date of delivery to the first user and subject to the following conditions:

APE's obligation and liability under this WARRANTY is expressly limited to repairing or replacing at APE's option, any parts which appear to APE upon inspection to have been defective in material or workmanship. Such parts shall be provided at no cost to the user, at the business establishment of APE or the authorized APE distributor of the product during regular working hours. **This WARRANTY, shall not apply to component parts or accessories of products not manufactured by APE** and which carry the warranty of the manufacturer thereof, or to normal maintenance (such as engine tune-up) or normal maintenance parts (such as filters).

Replacement or repair parts installed in the product covered by this WARRANTY are warranted only for the remainder of the warranty as if such parts were original components of said product. AMERICAN PILEDIVING EQUIPMENT, INC. makes no other warranty, expressed or implied and makes no warranty of merchantability of fitness for any particular purpose.

APE's obligation under this WARRANTY shall not include any transportation charges, costs of installation, duty, taxes or any other charges whatsoever, or any liability for direct, indirect, incidental or consequential damage or delay. If requested by APE, products or parts for which a warranty claim is made are to be returned transportation prepaid to APE. Any improper use, including operation after discovery of defective or worn parts, operation beyond rated capacity, substitution of any parts whatsoever, or parts not approved by APE or any alteration or repair by others in such manner as in APE's judgment affects the product materially and adversely, shall void this warranty.

**NO EMPLOYEE OR REPRESENTATIVE IS AUTHORIZED TO CHANGE THIS WARRANTY IN ANY WAY OR GRANT ANY OTHER WARRANTY UNLESS SUCH CHANGE IS MADE IN WRITING AND SIGNED BY AN OFFICER OF APE, INC.**

**ANY TYPE OF WELDING ON EQUIPMENT  
WILL VOID THE WARRANTY**





# OPERATION / MAINTENANCE MANUAL

MODEL 50 AUGER WITH MODEL 240 POWER UNIT

7032 SOUTH 196th - KENT, WA. 98032 - (206) 872-0141 / FAX (206) 872-8710

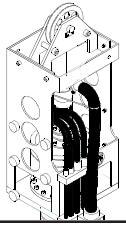

## I. GENERAL INFORMATION

### I-1. Machine Features.

#### **APE MODEL 50 AUGER**

*DIRECT FLUID - TO - TORQUE ROTATION*

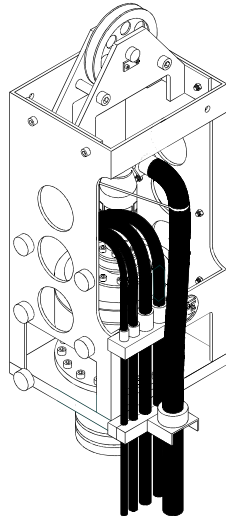

- Direct fluid-to-torque
- Half the weight of other drills
- Almost no moving parts
- No gears or planetaries to rob torque
- No gearbox
- No bull gears
- No pinion gears
- No gearbox lubrication requirements
- Only one motor
- Super high radial and axial loads
- Built-in speed change on the fly
- Quick stopping and reverse of rotation
- Camtrack technology - no maintenance

#### **APE MODEL 240 POWER UNIT**

*HYD POWER SOURCE FOR VIBROS, AUGERS, DECK WINCHES,  
HYD. IMPACT HAMMERS, ETC.*

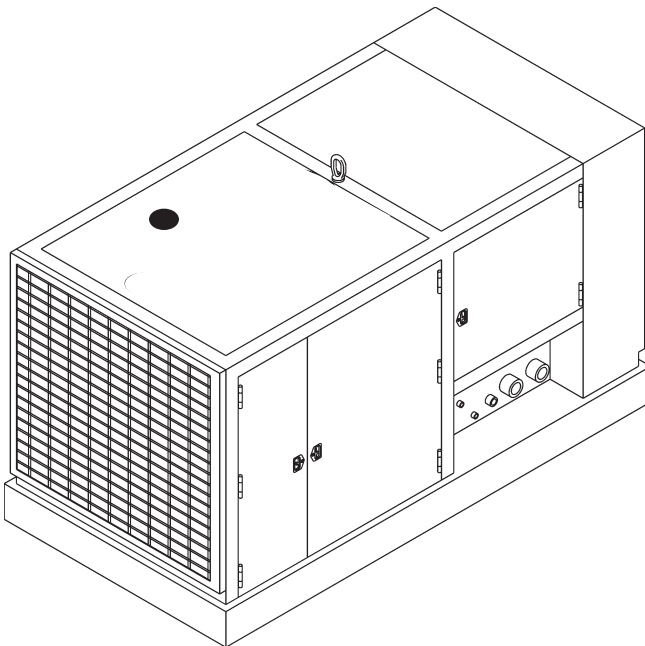

- Cummins engine
- 240 (179kW) horsepower
- Lockable sheet metal enclosure
- Hyd. flow from 0 to 80 gpm (454 l)
- 4500 (310 bar) psi system
- Complete tool box provided
- Bi-directional flow for auger work
- 50 foot (15m) electric pendant
- Backup controls mounted on panel
- Engine safety shutdowns built in
- Sound reduction by design
- Easy to change hydraulic filters
- One loop hydraulic system
- Large cooler keeps oil temp down
- Enough power to run larger vibros

**Figure 1-A. Machine Features**



# OPERATION / MAINTENANCE MANUAL

MODEL 50 AUGER WITH MODEL 240 POWER UNIT

7032 SOUTH 196th - KENT, WA. 98032 - (206) 872-0141 / FAX (206) 872-8710

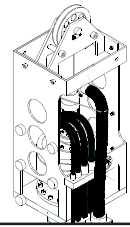

## I. GENERAL INFORMATION (Continued...)

### I-2. Machine Specifications

#### I-2A. Model 50 Auger - (Table 1-A.)

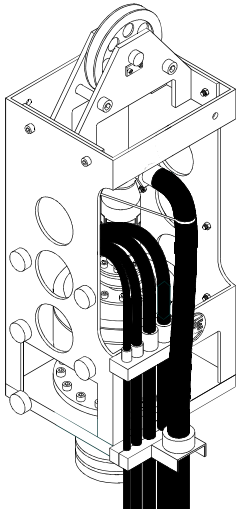

Type:	Direct flow-to-torque hydraulic
Torque:(in low speed position)	50,000 ft. lbs.
Torque:(in high speed position)	25,000 ft.lbs.
Speed at high torque*	30 rpm
Speed at low torque*	60 rpm
Axial capacity	80,000 lbs.
Radial capacity	80,000 lbs.
Weight:	3,000 lbs.
Width:	25 inches
Length:	25 inches
Height: (with top sheave)	60 inches
Hydraulic hose length	100' (30m)
Swivel:	King type 3" 3000 hr./5000 psi

\* APE can limit drill to 30,000 ft. lbs. by setting power unit relief valve setting to 3500 psi if 50,000 ft. lbs. is too much for your leads.

#### I-2B. Model 240 Power Unit - (Table 1-B.)

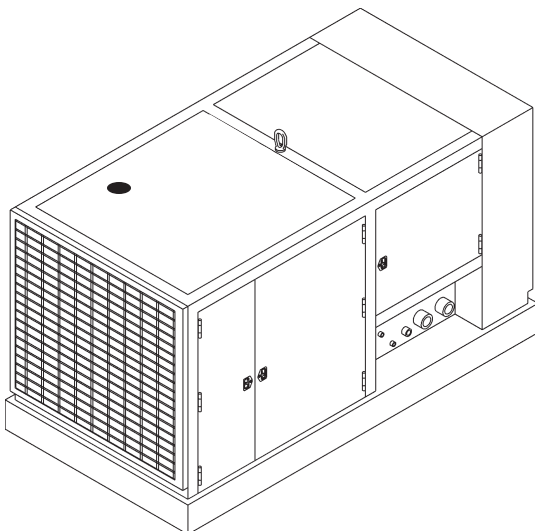

Engine	240 h.p. Cummins 6CT8.3
Maximum Power	240 (179 kW)
Operating Speed	2200 rpm
Maximum Drive Pressure	4,500 psi (310 bar)
Max.Hyd.Flow - Forward	80 gpm (328 lpm)
Max.Hyd.Flow - Reverse	80 gpm (328 lpm)
Clamp Pressure*	4,500 psi (310 bar)
Clamp Pump Flow @ 2100 rpm	6.5 gpm (25 lpm)
Weight*	6,800 lbs (3,090 kg)
Length	102" (260 cm)
Width	50" (127 cm)
Height	68" (152 cm)

**Dimensions may vary depending on the year and model.  
Consult the factory for certifications on unit being used.**



# OPERATION / MAINTENANCE MANUAL

MODEL 50 AUGER WITH MODEL 240 POWER UNIT

7032 SOUTH 196th - KENT, WA. 98032 - (206) 872-0141 / FAX (206) 872-8710

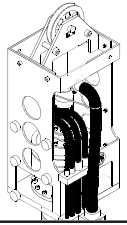

## I. GENERAL INFORMATION (Continued...)

### I-3. General Description of Model 50 Auger

The **Model 50** auger is a high pressure piston/lobe direct flow hydraulic motor that converts fluid power directly to torque without the use of planetary gear reductions, bull gears, pinion shafts, chains, and related parts which require maintenance and reduce horsepower to do work. The **APE Model 50** does not have a gearbox and therefore does not require lubrication. All the moving parts are permanently lubricated by the hydraulic fluid. The only parts on the drill that requires maintenance is the grout swivel which has two grease fittings that must be greased while rotating. The **Model 50** auger was originally designed to rotate ditch digging equipment where high pressure spikes occur when the digging equipment hits rocks or other obstructions. The **APE** drill can drill through the toughest material without worry of damage to the internal parts. The reduced number of moving parts and their low speed guarantee a long life for the motor with little pollution effects, especially on the faces of distribution.

The two major parts to the Model 50 are as follows:

- A.) The Outer housing.
- B.) The Auger Motor

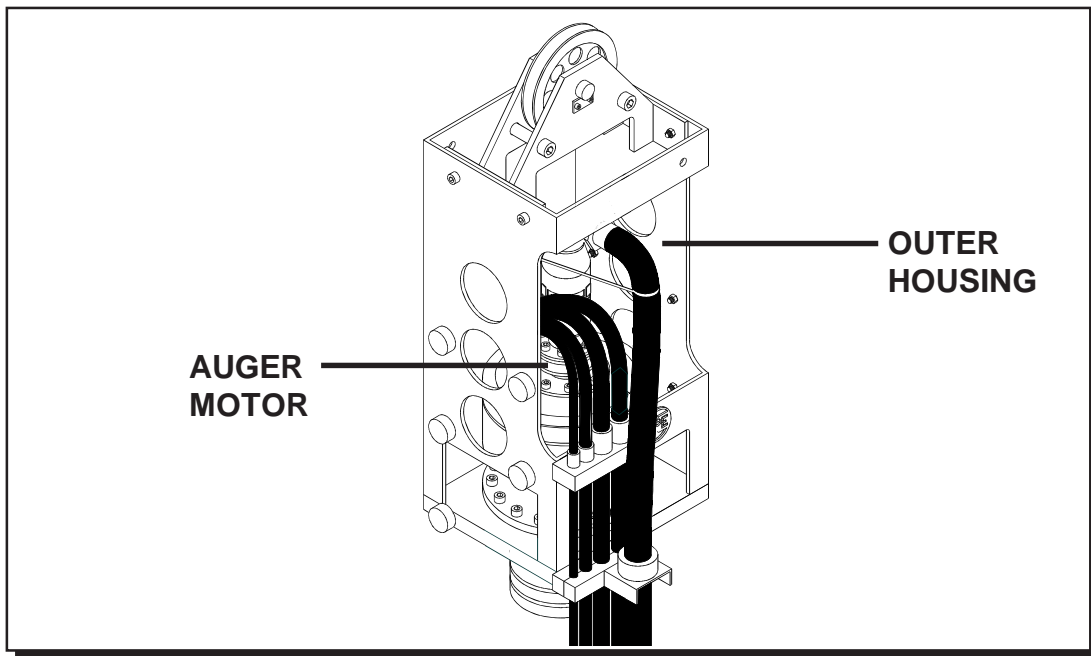

Figure 1-B. General Description of Model 50 Auger.



# **OPERATION / MAINTENANCE MANUAL**

**MODEL 50 AUGER WITH MODEL 240 POWER UNIT**

7032 SOUTH 196th - KENT, WA. 98032 - (206) 872-0141 / FAX (206) 872-8710

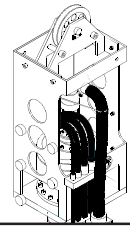

## **I. GENERAL INFORMATION (Continued...)**

### **I-3A. The Outer Housing.**

The Outer Housing of the Model 50 Auger is a steel shell surrounding the main components of the auger motor assembly. The auger housing and its components are designed to be compatible with most standard pile leads. The Auger is guided along the leads by twelve heavy duty guide rollers which are mounted on both sides of the housing shell. The mounting placement of the rollers allows easy access for maintenance or replacement. A lifting sheave is mounted at the top of the housing with a removable shaft. After the Model 50 has been placed into the pile leads, a steel wire cable must be connected through the lifting sheave. The required strength of the cable depends on the weight of the objects being lifted and the lifting capacity. A safety factor of six is recommended when considering the cable strength.

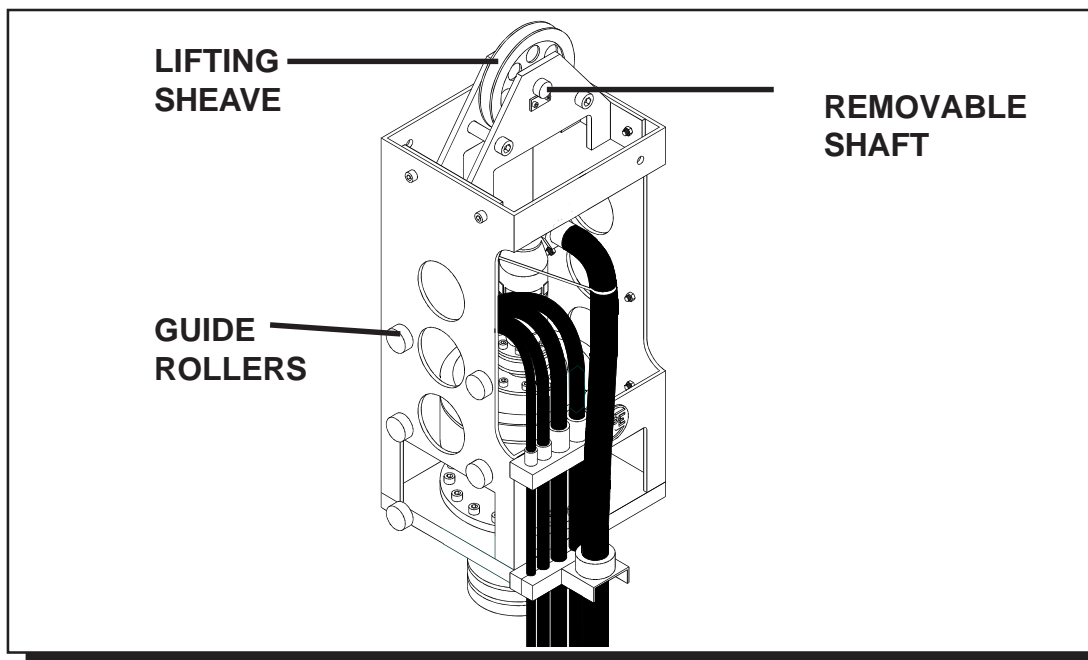

**Figure 1-C. General Description of the Outer Housing**



# OPERATION / MAINTENANCE MANUAL

MODEL 50 AUGER WITH MODEL 240 POWER UNIT

7032 SOUTH 196th - KENT, WA. 98032 - (206) 872-0141 / FAX (206) 872-8710

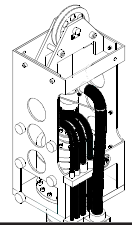

## I. GENERAL INFORMATION (Continued...)

### I-3. Basic Working Principles of Model 50 Auger

The **Model 50** auger is a high pressure piston/lobe direct flow hydraulic motor that converts fluid power directly to torque without the use of planetary gear reductions, bull gears, pinion shafts, chains, and related parts which require maintenance and reduce horsepower to do work. The **APE Model 50** does not have a gearbox and therefore does not require lubrication. The only parts on the drill that requires maintenance is the grout swivel which has two grease fittings that must be greased while rotating.

#### First piston position:

To start the cycle, oil is fed under pressure to the valve assembly, passes through it and pushes the piston. Moved by the pressure, the roller pushes down on the cam lobe and causes the cylinder block to rotate.

#### Second piston position:

As the piston descends, supply pressure passes through a maximum opening, then diminishes.

#### Third Piston position:

When the piston reaches the bottom of the lobe, the oil supply is cut off. Drive power stops. This is neutral position. Another piston must take over from the first one and make it climb the following lobe.

#### Forth piston position:

When the piston starts its climb, oil can escape to the reservoir through a port being opened in the valve assembly. This is the beginning of the discharge cycle.

#### Fifth piston position:

A piston continues its climb, port in the valve assembly progressively enlarges, then a progressive closing of the discharge hole takes place. When it has reached the top of the lobe (neutral position), the piston will repeat the previous cycle. The direction of rotation of the motor can be changed by reversing the input of the supply.

#### Dual displacement:

In order to create a "gear box" function, and increase speed of rotation, a selector valve cuts oil supply to five of the ten pistons, thus creating twice the speed with the same flow of oil.

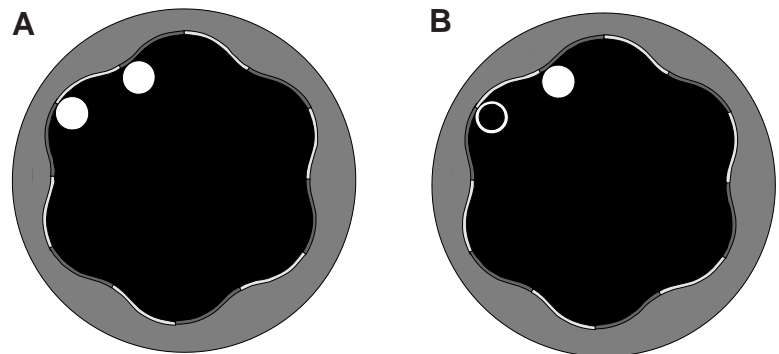
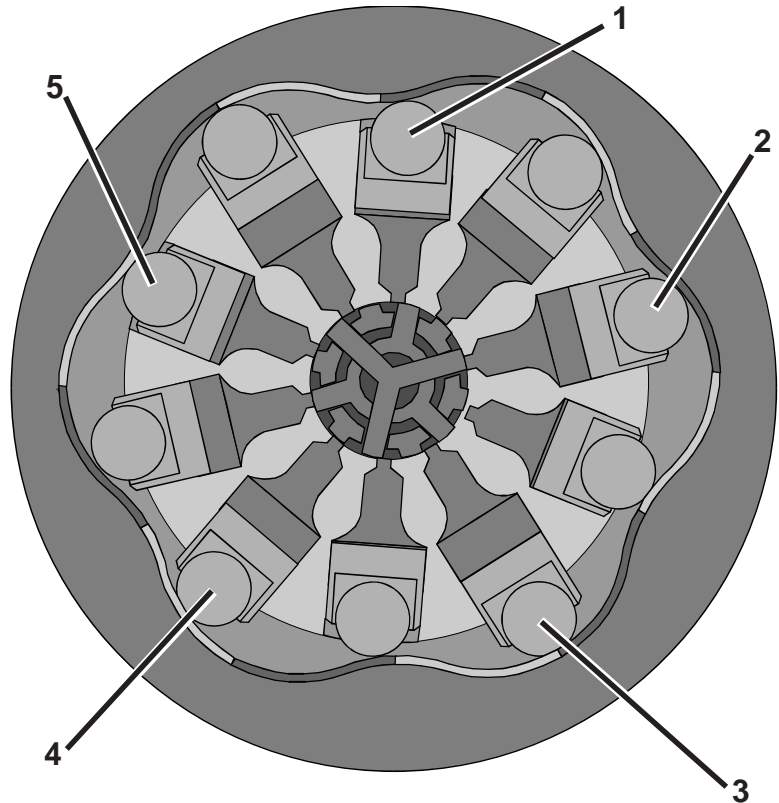



# OPERATION / MAINTENANCE MANUAL

MODEL 50 AUGER WITH MODEL 240 POWER UNIT

7032 SOUTH 196th - KENT, WA. 98032 - (206) 872-0141 / FAX (206) 872-8710

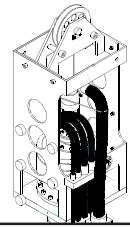

## I. GENERAL INFORMATION (Continued...)

### I-4. General Description of Model 240 Power Unit

The Power unit for the Model 50 auger is powered by a Cummins 6CT8.3 engine developing 240 horse power at 2200 rpm and provides hydraulic flow in both forward and reverse directions. The engine is mounted to a tubular frame that also serves as a diesel fuel tank. A sheet metal and tube frame covers the engine and is equipped with locking doors for protection from the environment. A control panel is located behind one of the doors and comes complete with a 50 foot control pendant. A hydraulic tank supplies oil to four pumps. Three pumps feed the auger motor and a small pump supplies oil to the two-speed selector valve. The auger is connected to the power unit via five hydraulic hoses. The two large 1 1/2" hoses are the pressure and return lines for the auger motor. One small 3/8" hose is for the two-speed selector and the one middle sized 1 " hose is the motor case drain line. The hoses are attached to the power unit by connecting the "quick disconnect fittings" on the end of the hoses leading from the auger. The fittings can go on only one way so there is no chance of hooking up the hoses improperly.

**WARNING:** Clean with ether or a clean rag before installing quick disconnects. Make sure you seat the quick disconnect fittings all the way tight. Failure to tighten the quick disconnects will stop the flow of oil and will prevent the auger from operating. Failure to tighten the selector fitting completely will cause the two speed valve not to function or cause the pistons to chatter in the auger motor. If this happens you may have to crack the fitting and bleed off the pressure to install the quick disconnect.

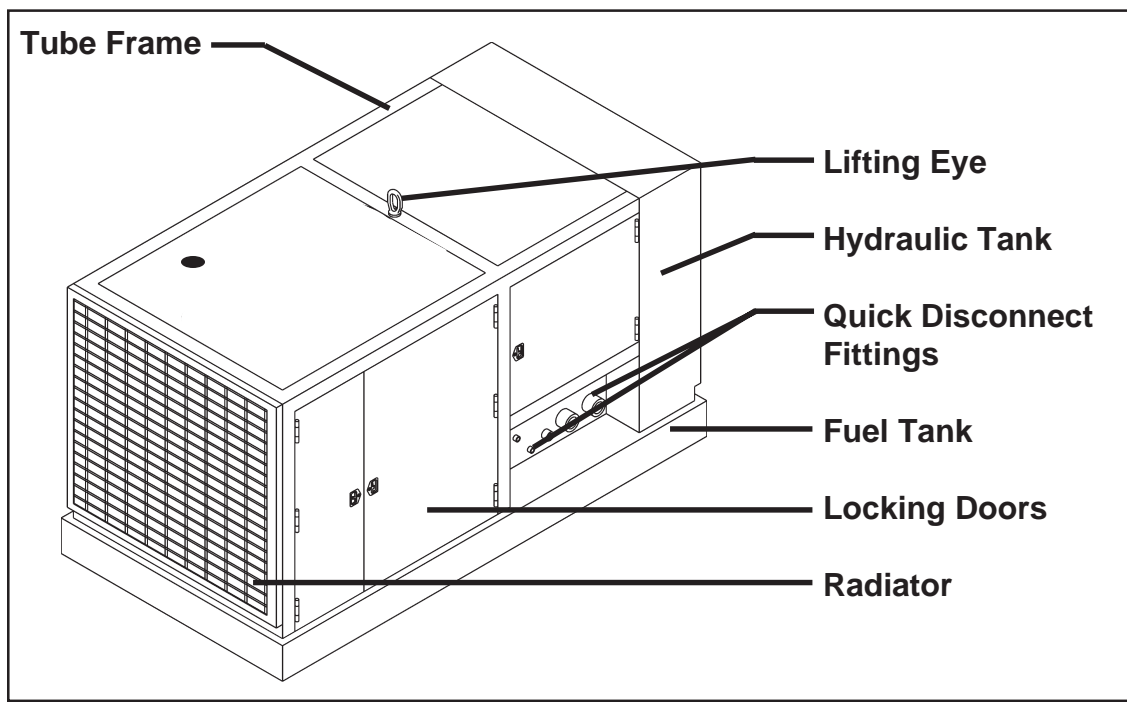

**Figure 1-H. General Description of Model 240 Power Unit**



# OPERATION / MAINTENANCE MANUAL

MODEL 50 AUGER WITH MODEL 240 POWER UNIT

7032 SOUTH 196th - KENT, WA. 98032 - (206) 872-0141 / FAX (206) 872-8710

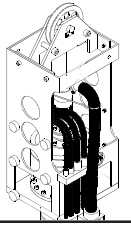

## II. COMPONENT DEFINITION

### II-1. Component Identification - Model 50 Auger.

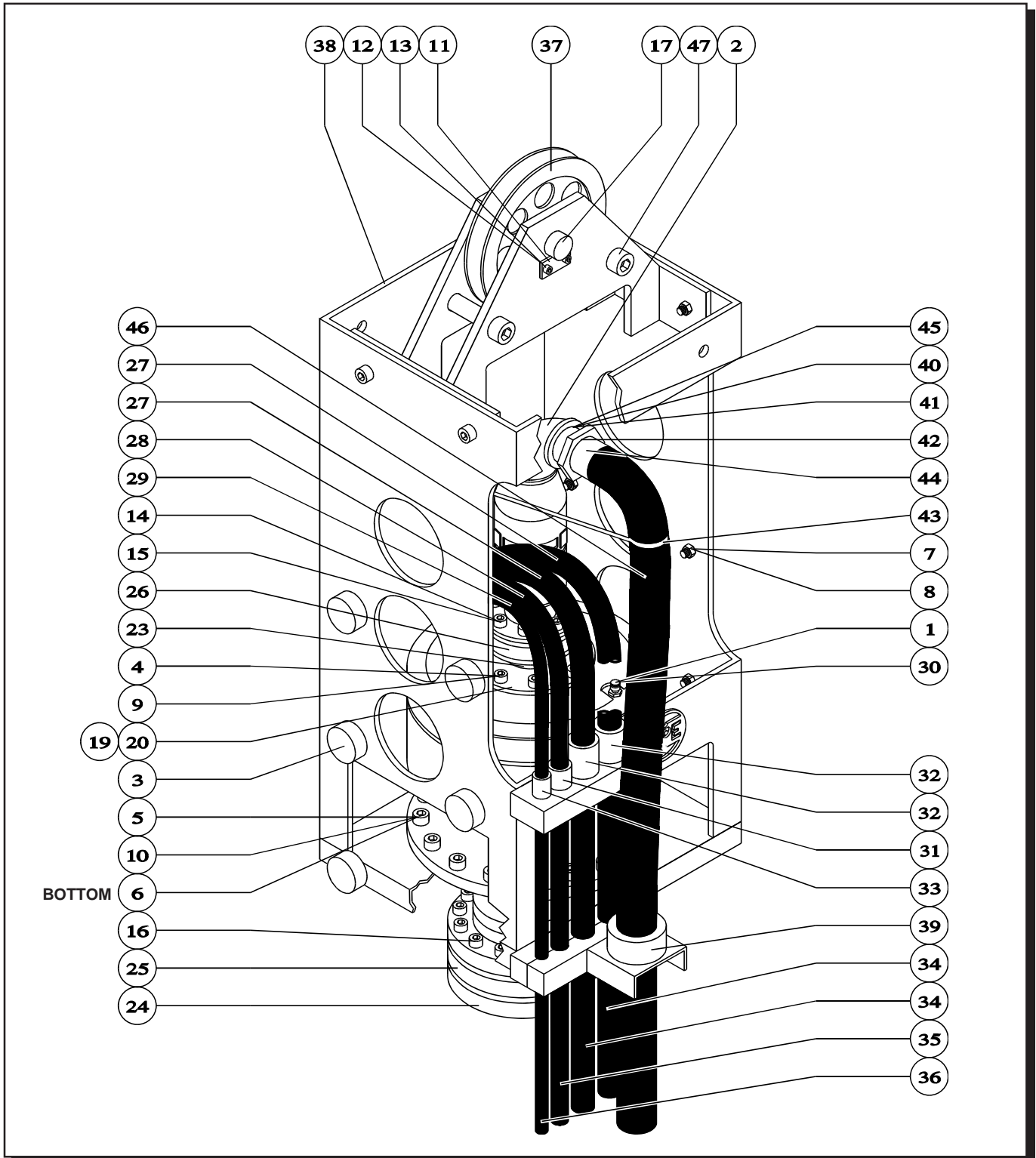

**Figure 2-A. Component Identification.**



# OPERATION / MAINTENANCE MANUAL

MODEL 50 AUGER WITH MODEL 240 POWER UNIT

7032 SOUTH 196th - KENT, WA. 98032 - (206) 872-0141 / FAX (206) 872-8710

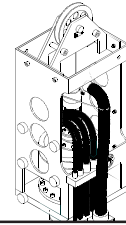

## II. COMPONENT DEFINITION (Continued...)

### II-1. Component Identification

The following is a general listing of the APE 50 Major components and part numbers. (Please see Figure 2-A. for component location).

**Table 2-A. Component Identification.**

Item	Qty	Description	Part #
1	—	Safety Valve, Circle Seal Pop-Off Valve	#321009
2	—	Swivel, King	#630001
3	—	Roller, Guide	#630003
4	—	Bolt, Top Seal Plate, M20 x 2.5 x 60 Hex	#630020
5	—	Washer, Housing Bolt 7/8", Hi-Collar Lock washer	#630005
6	—	Nut, 7/8" NC, Grade 8	#630006
7	—	Washer, Roller Guide, 1 1/4" Med. Lockwasher	#630007
8	—	Jam Nut, 1 1/4"-12 UNC	#630008
9	—	Washer, Top Seal Plate, M20 x 2.5, Lockwasher	#630018
10	—	Bolt, Motor to Housing, SHCS 7/8" NC x 5"	#630010
11	—	Locking Plate, Pin	#630023
12	—	Bolt, Locking Plate, 1/2"x1" NC	#630024
13	—	Washer, Locking Plate, 1/2" Hi-Collar	#630025
14	—	Bolt, Small Bikon Coupling, 5"x 7/16"	#630026
15	—	Washer, Small Bikon Coupling, 7/16"	#630027
16	—	Bolt, Lower Bikon Coupling	#630028
17	—	Pin, Lifting	#630029
18	—	Plate, Top Seal	#630030
19	—	Dust Seal, RST-105 x 130 x 12	#630031
20	—	High Pressure Seal, SG7200-1522	#630032
21	—	Seal Retaining Plate	#630033
22	—	O-Ring, AS-259	#630034
23	—	Shaft, Drill	#630500
24	—	Output Flange	#630501
25	—	Bikon Coupling, 200-01 Output Shaft	#630502
26	—	Coupler, Bikon 25-01, SPLIT 1.5	#630503/4
27	—	Hose, Forward/Reverse, 5000 psi, 1 1/4"x48" w/90 Degree 1 1/4" Code 62 Split Flange One End, Straight 1 1/4" Female JIC swivel Other End (Bolt, M14 x 50 w/M14 L.W #630004/#630009)	#631001
28	—	Hose, Motor Case drain, 2250 psi, 3/4"x48" w/90 Degree 3/4" JIC Female Swivel One End, Straight 3/4" JIC Female Swivel Other End	#631003
29	—	Hose, Two Speed, 2250 psi, 3/8"x48" w/90 Degree 1/2" Female JIC swivel One End, Straight 3/8" JIC Swivel Other End	#631004
30	—	Fitting, 1/2" Female Pipe To 27mm Male German Thread	#631005
31	—	Fitting, Male Pipe to Male JIC	#631032
32	—	Fitting, Male Pipe to Male JIC 1 1/4"	#631034
33	—	Fitting, Male Pipe to Male JIC	#631036
34	—	Hose, 1 1/2"x50', 5000 psi w/ 1 1/2" Female JIC Swivel Both Ends	#631037
35	—	Hose, 1"x50', 2500 psi w/ 1" Straight Female JIC Swivel Both Ends	#631038
36	—	Hose, 3/8" 2250 psi w/Straight Female JIC Both Ends	#631039
37	—	Sheave, Lifting	#950900
38	---	Outer Housing	#950901
39	---	2" Black Pipe Coupling	#631042
40	---	Bushing, 3" Male Pipe to 2" Female Pipe	#631040
41	---	2" Pipe Nipple	#631041
42	---	WE 20D 2" Weld-On End	#631028
43	---	Safety Cable, Grout Hose #WSR 2DIXON	#631025
44	---	2" C20SD Heavy Duty Clamp	#631027
45	---	Gasket, Model 200 Collar	#631029
46	---	2"x 5' Grout Hose w/WE25D Heavy Duty Swedge One End, 2" Male Pipe Other End	#631023
47	---	Bolt, SHSC 3/4"x 6" w/ top lock nut	#634104





# OPERATION / MAINTENANCE MANUAL

MODEL 50 AUGER WITH MODEL 240 POWER UNIT

7032 SOUTH 196th - KENT, WA. 98032 - (206) 872-0141 / FAX (206) 872-8710

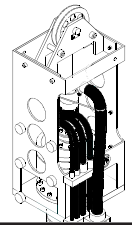

## II. COMPONENT DEFINITION (Continued...)

### II-2. Model 240 Power Unit Skid Identification.

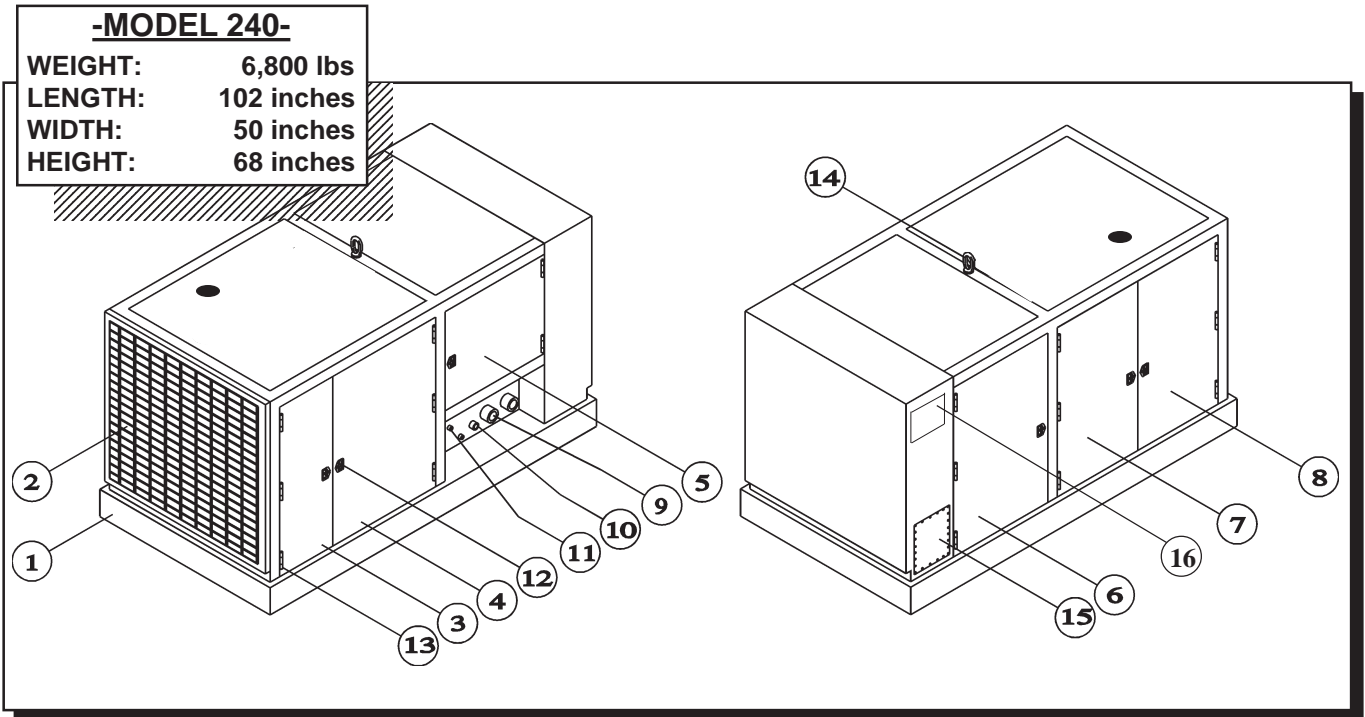

**Figure 2-C. Model 240 Power Unit Skid Identification.**

**Table 2-C. Model Power Unit Skid Identification**

#### Model 240 Power Unit

Item	Qty	Description
1	1	Model 240 Power Unit Skid
2	1	Radiator Grill
3	1	Door 21 1/2" x 51 1/2"
4	1	Door 45 3/4" x 51 1/2"
5	1	Door 21 1/2" x 20"
6	1	Door 21 1/2" x 51 1/2"
7	1	Door 33 5/8" x 51 1/2"
8	1	Door 33 5/8" x 51 1/2"
9	2	1 1/2" Hydraulic Coupling
10	1	3/4" Hydraulic Coupling
11	2	3/8" Hydraulic Coupling
12	6	Door Handle / Lock
		Lock-#EMC 56462W Two Point Lock
		Handle-#EMC 48742W Locking Handle
13	17	Hinges #R140-150 Weld On Hinge
14	1	Lifting Eye Nuts - Crosby Laughlin #6-400 #10
15	1	Access Cover Plate 15" x 18"
16	1	Access Cover Plate 12" x 15"



# OPERATION / MAINTENANCE MANUAL

MODEL 50 AUGER WITH MODEL 240 POWER UNIT

7032 SOUTH 196th - KENT, WA. 98032 - (206) 872-0141 / FAX (206) 872-8710

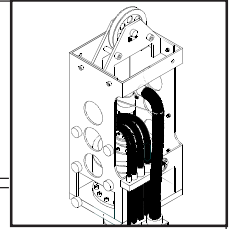

## II. MAJOR COMPONENT DEFINITION (Continued...)

### II-3. Quick Disconnect Couplings.

The APE Quick Disconnect Couplings are high pressure hydraulic couplings designed for rugged applications. Service in many such applications has proven the design compatible to extreme pressures, structural and system induced shock loads. The construction of the coupling assembly promotes ease of use and maintenance.

#### Design Features:

- Excellent flow characteristics for continuous duty applications.
- High strength design endures high surge and shock conditions.
- Flat crested stub-ACME threads and all steel construction withstand storage and rig-up damage.
- Structurally compatible with weight of 5,000 P.S.I. flex-hose and system induced shock loads.

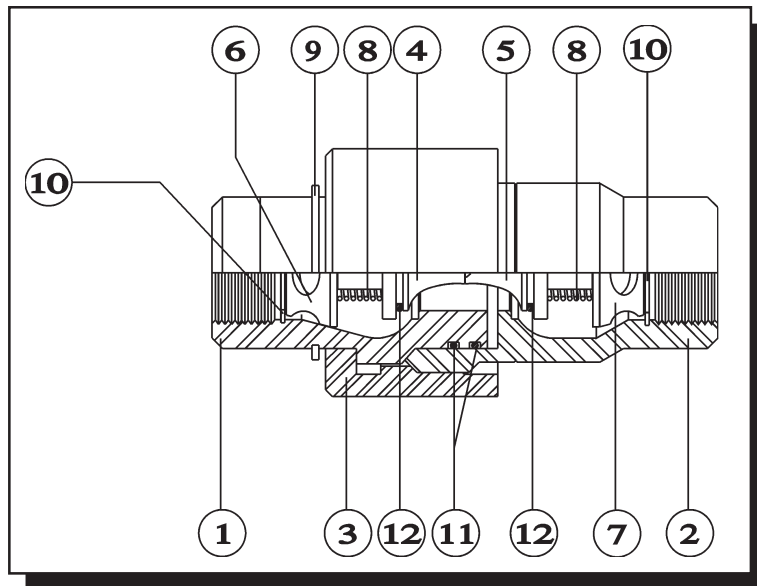

**Figure 2-D. Quick Disconnect Coupling Identification.**

**Table 2-D. Quick Disconnect Coupling Identification.**

Item	Qty	Description
1	1	Q.D. Hydraulic Female Coupling #400301
2	1	Q.D. Hydraulic Male Coupling #400303
3	1	Q.D. Hydraulic Coupling Sleeve #400302
4	1	Q.D. O-Ring Carrier "A" #400202
5	1	Q.D. O-Ring Carrier "B" #400201
6	1	Q.D. Plunger #400101
7	1	Q.D. Plunger #400101
8	1	Q.D. Plunger Spring #400701
9	1	Retaining Ring - "Inverted External" #I-275
10	2	Retaining Ring - "Truarc Internal" #N5000-168
11	2	Parker O-Ring #2-230 & One Parback
12	2	Parker O-Ring #2-216



# OPERATION / MAINTENANCE MANUAL

MODEL 50 AUGER WITH MODEL 240 POWER UNIT

7032 SOUTH 196th - KENT, WA. 98032 - (206) 872-0141 / FAX (206) 872-8710

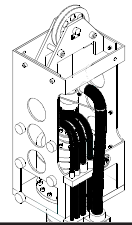

## II. MAJOR COMPONENT DEFINITION (Continued...)

### II-4. Tool Set Identification.

Mounted inside the **Model 240 Power Unit** is a set of tools frequently used for the maintenance of the **APE Model 50 Auger**. The following figure and table shows the location and the use for each tool.

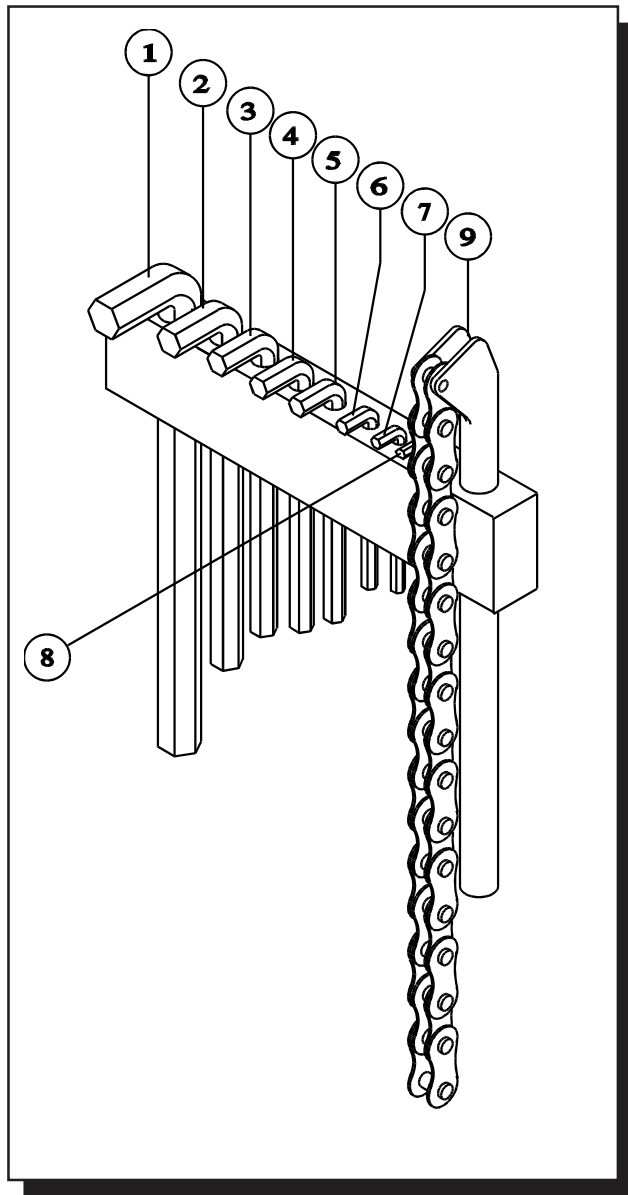

**Table 2-E. Tool Set Identification.**

ITEM	QTY	DESCRIPTION	PART#
1	1	1" Allen Wrench	#50004
For use with the clamp attachment bolts			
2	1	3/4" Allen Wrench	#50006
For use with clamp fixed jaw, sheet guide			
3	1	5/8" Allen Wrench	#95007
For hydraulic motor, drain plug, top plate			
4	1	9/16" Allen Wrench	#50013
For use with the fill plugs			
5	1	1/2" Allen Wrench	#50008
For use with the double split flange bolts			
6	1	3/8" Allen Wrench	#50009
For use with bearing cover bolts			
7	1	5/16" Allen Wrench	#50014
For use with the hose bracket bolts			
8	1	1/4" Allen Wrench	#50015
For use with the vibro oil level check			
9	1	Chain Wrench	#50011
Used to tighten the quick disconnects			

**Figure 2-E. Tool Set Identification.**



# OPERATION / MAINTENANCE MANUAL

MODEL 50 AUGER WITH MODEL 240 POWER UNIT

7032 SOUTH 196th - KENT, WA. 98032 - (206) 872-0141 / FAX (206) 872-8710

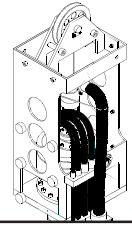

## II. MAJOR COMPONENT DEFINITION (Continued...)

### II-5. Upper Shaft Coupling Assembly.

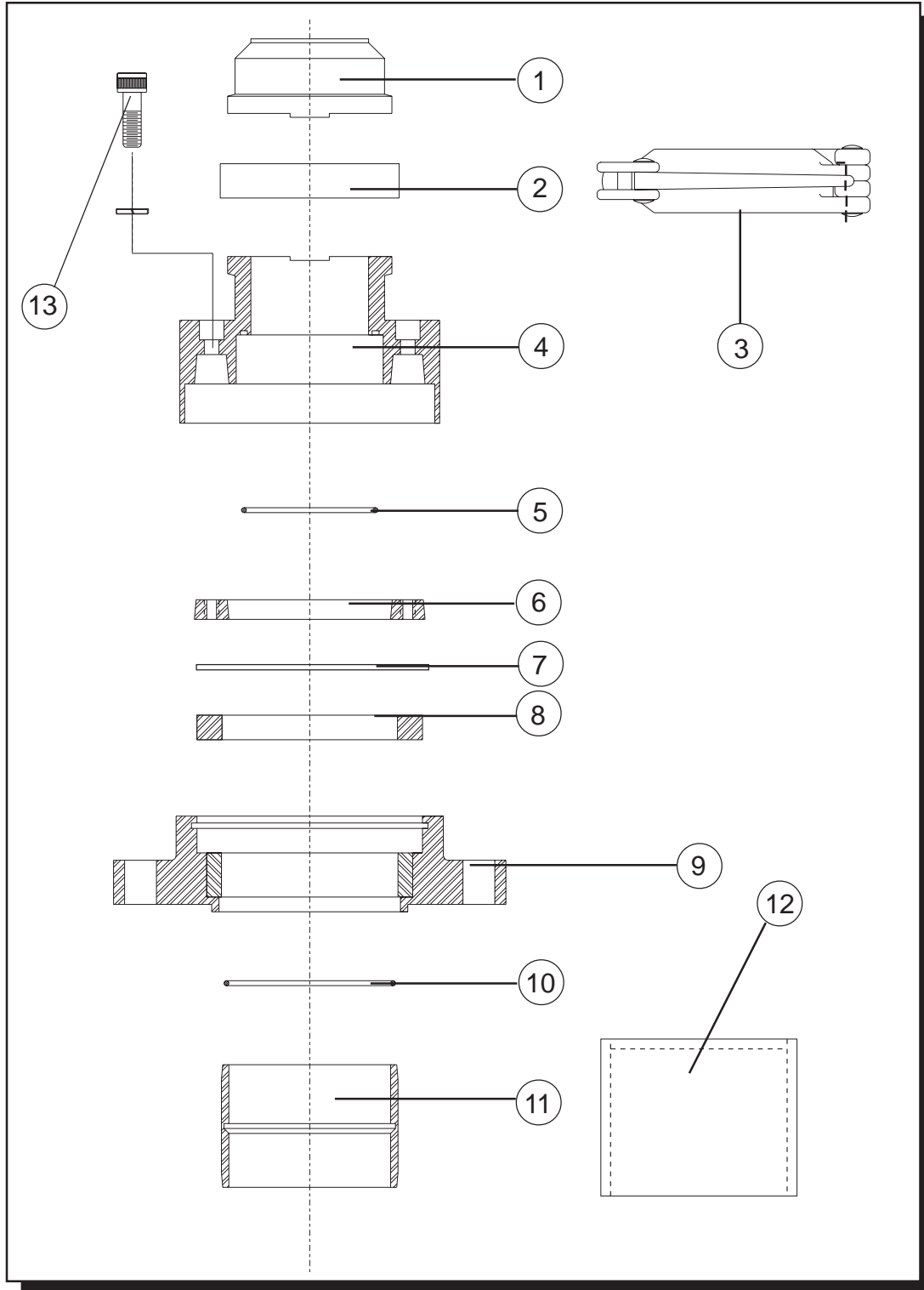

**Figure 2-E. Upper Shaft Coupling Assembly**



# OPERATION / MAINTENANCE MANUAL

MODEL 50 AUGER WITH MODEL 240 POWER UNIT

7032 SOUTH 196th - KENT, WA. 98032 - (206) 872-0141 / FAX (206) 872-8710

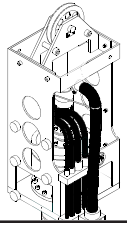

## II. MAJOR COMPONENT DEFINITION (Continued...)

### II-5. Upper Shaft Coupling Assembly.

**Table 2-E. Upper Shaft Coupling Assembly**

Item	Qty	Description	APE Part #	Drawing #
1	1	H.D. Weld on w/Key	#631052	#C1194-005
2	1	3" H.D. Seal, Cam Lock	#631053	---
3	1	3"H.D. Clamp, ACME #6F-201F	#631051	---
4	1	Adapter Flange	#630506	#C0994-002
5	1	O-Ring "Parker" #2-236	#630037	---
6	1	Clamp Ring	#630507	#B0994-001
7	1	Snap Ring, Internal #	#630508	---
8	1	Upper Shaft Seal, JIM Clipper #0450-15787	#630510	---
9	1	Upper Shaft Seal Plate w/Oilite Bushing #AA52	#630509	#C0994-001
10	1	O-Ring "Parker" #2-243	#630035	---
11	1	Upper Shaft Sleeve	#630505	#B0994-002
12	1	Sleeve Assembly Tool	#50019	---
13	8	Bolt, 3/8-24 x 1 1/4" w/L.W.	#630036	---



# **OPERATION / MAINTENANCE MANUAL**

**MODEL 50 AUGER WITH MODEL 240 POWER UNIT**

7032 SOUTH 196th - KENT, WA. 98032 - (206) 872-0141 / FAX (206) 872-8710

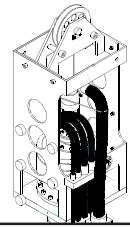

## **III. LOADING AND UNLOADING**

### **III-1. Model 50 Auger.**

The APE 50 auger is normally shipped laying flat on the trailer deck and the hose bundle is coiled on top. Lift the auger and hose bundle as one load. Avoid smashing hydraulic lines. Auger should be loaded with the swivel king and hoses facing the sky. Before the truck has left, carefully inspect the machine and hoses for any missing equipment or sign of damage that may have occurred during shipment or unloading.

### **III-2. Model 240 Power Unit.**

The Power Unit is always loaded with the oil cooler facing to the rear of the truck to prevent damage to the cooler and the radiator from flying objects. The Power Unit is usually held to the truck by wrapping a chain around both ends of the fuel tank base and the truck bed. After loading the Power Unit, tape the exhaust rain cap shut to prevent rain water from getting inside. If quick disconnects do not have safety cables then store them under the panel in the storage box rather than risk the possibility of the caps and plugs coming loose and falling off into traffic. Make sure all doors are fully closed. Tighten fuel cap to prevent diesel fuel from washing out the fill spout.

### **III-3. What to do if damaged during shipment.**

In the event of damage, notify the trucking agent at once. Note all damage on the bill of lading. Fax the information as soon as possible, any delay may make it impossible to find the responsible party.



# **OPERATION / MAINTENANCE MANUAL**

MODEL 50 AUGER WITH MODEL 240 POWER UNIT

7032 SOUTH 196th - KENT, WA. 98032 - (206) 872-0141 / FAX (206) 872-8710

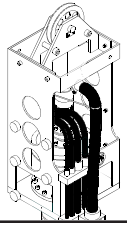

## **IV. PREPARATION AND OPERATION**

### **IV-1. Filling Auger Pressure Hose.**

The auger is shipped with the hoses filled with oil. However, if the unit has been sitting for a long period of time or if a damaged hose has been replaced with a new one, then the hoses must be filled. Hook up all the hoses to the power unit. Start the power unit and let it run for ten minutes before running the auger. The hoses will fill up by themselves in ten minutes even if the auger is not running.

### **IV-2. Changing Speeds On The Drill.**

The Model 50 has two speeds. However, speed of rotation can be fine tuned by throttling the engine rpm up or down. For maximum torque at low speeds turn the clamp switch to OFF. This will de-energize the two-speed valve, slow the rotation down, and give you maximum torque. Then slow the engine down if you need slower rotation speeds.

To get maximum speed, turn clamp switch to CLOSED. This will energize the two-speed valve on the drill motor by sending 500 psi of oil pressure to the spool which shifts the spool and blocks delivery to half the pistons which doubles the speed. Turning the engine rpm to full throttle gives you the maximum rpm if the spool is energized.

### **IV-3. Shutdown Procedures.**

1. Stop drill.
2. Turn clamp switch to OFF.
3. Reduce speed to low idle for a couple of minutes.
4. Stop the engine by turning the ENGINE START switch to OFF.

#### **WARNING!**

If the diesel engine is shut down while the clamp switch is in the CLOSED position, the small 3/8" quick disconnect may be difficult to remove. This is because it may still have 500 psi pressure on it. Start engine and turn clamp switch to OFF first, then shut engine down.



# OPERATION / MAINTENANCE MANUAL

MODEL 50 AUGER WITH MODEL 240 POWER UNIT

7032 SOUTH 196th - KENT, WA. 98032 - (206) 872-0141 / FAX (206) 872-8710

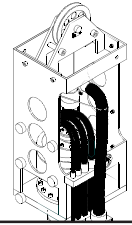

## IV. PREPARATION AND OPERATION (Continued...)

### IV-4. Plumbing the Vibro Hoses to the Power Unit.

There are five hoses leading from the vibro that must be connected to the power unit to begin operation. There are two big hoses, two little hoses and one middle sized hose. The hoses attach to the power unit by screwing the quick disconnect couplers onto the proper couplers of the power unit. The couplers on the power unit are mated with the couplers on the vibro so there is no chance of putting them on backwards. Please take the following steps when installing the couplers:

**WARNING: TURN THE POWER UNIT OFF BEFORE INSTALLING COUPLERS**

- 1.) Turn the power unit OFF.
- 2.) Clean all couplers with a can of ether if available. A clean dry cloth will also work but will require extreme care. Fittings must be spotlessly clean.
- 3.) Install couplers by screwing them onto their respective counterparts. Try to avoid cross-threading and maintain a straight line. Jerk the hose back and forth while turning coupler to aid installation effort. **Push hard to get the big coupler threads started.**
- 4.) Make sure fittings are tight. If they are properly cleaned they should run up tight with just a firm hand grip. However, they should be double checked with a chain wrench.
- 5.) Avoid over-tightening.
- 6.) If near salt water, spray with a light oil to prevent oxidation.
- 7.) Position the Power Unit so that vibrator has enough hose to reach the work. Avoid pulling too hard on hoses. Most hose failures are caused by pulling hoses off couplers.

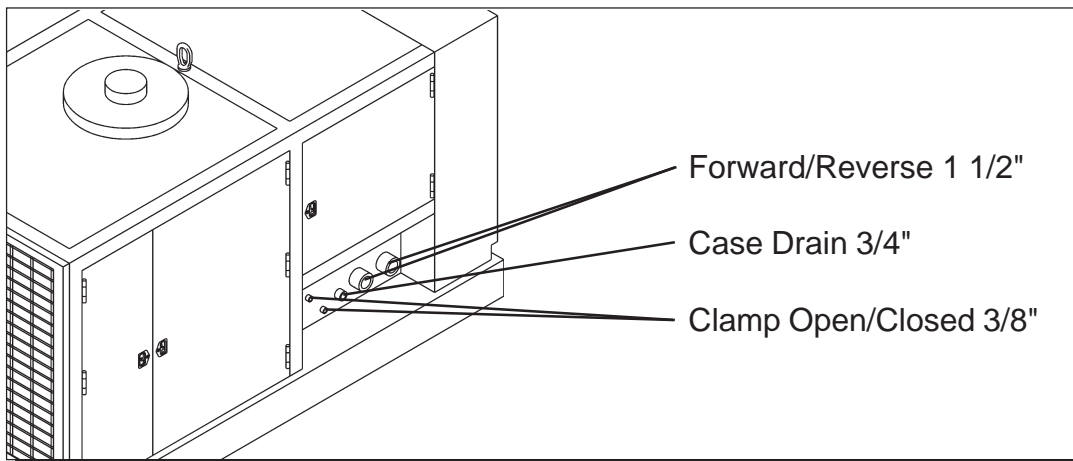

**Figure 4-A. Power Unit Coupler Layout**



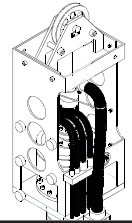

### IV. PREPARATION AND OPERATION (Continued...)

#### IV-5. Operation of the Remote Control Pendant.

1. All functions of the auger can be controlled by the hand held pendant. It is the choice of the crew as to where best to locate the pendant. Some prefer to give it to the crane operator so he can control all functions. Others prefer to give it to one of the ground crew so that he can position himself close to the work at hand. A 50 foot cord is provided as standard equipment. If this is not long enough, additional 50 foot sections can be added. Should the pendant become damaged, all functions can be manually operated. See Section VII-3, Page 7-10 in this manual for more details on operation. See Section VII-3A, Page 7-11 of this manual for wiring diagram and pendant components.

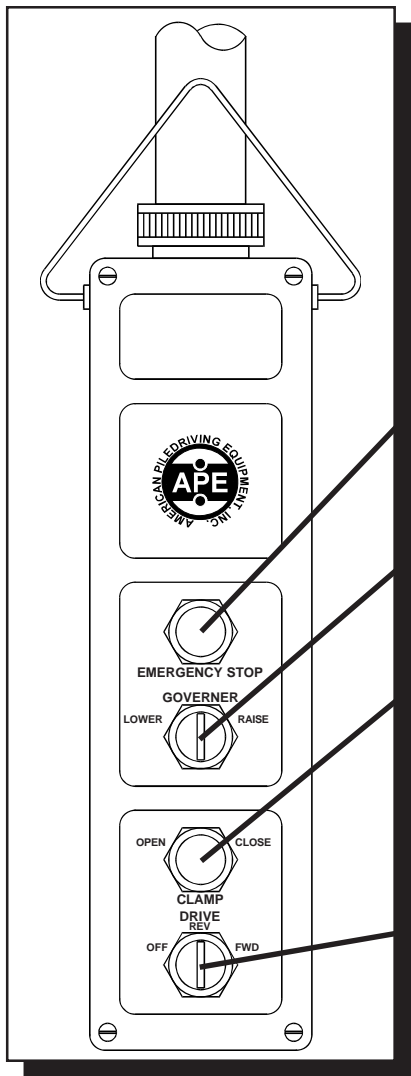

**ENGINE EMERGENCY SHUTDOWN SWITCH:**  
Press and hold to shut engine off. Do not use to shut engine off at the end of shift. Shut unit off at panel at end of shift. Button is for emergency only.

**ENGINE THROTTLE "RAISE/LOWER" RPM:**  
Three Position Switch. Press and hold button to raise or lower deisel engine rpm.

**CLAMP OPEN/CLAMP CLOSE:**  
Lighted switch. Move to **close** to extend jaw and clamp vibro to pile. Light comes on when clamp is closed and locked. Turn to **open** to retract jaw and release vibro from pile. Switch must remain in **closed** position to hold clamp to pile. Sometimes the light will not come on. It could be burnt out or shorted. Check clamp pressure gauge and make sure it reads at least 3800 psi before vibrating any pile. Contact APE if light is not working.

**FORWARD/OFF/REVERSE:**  
Three position switch. Turn to **forward** to operate vibro. Turn to **off** to stop vibro. Turn to **reverse** when using power unit to run a drill motor. Vibro is not supposed to vibrate in reverse. If it does then switch the two yellow cables labled "drive" and "reverse" located on the other side of the control panel.

**Figure 7-A. Remote Control Pendant.**

**WARNING:** Never leave vibro clamped to a pile without the crane line attached. The clamp cylinder could bleed off causing the vibro to drop. Never hoist a pile in the air without a safety line attached to the pile. Should the clamp close line become damaged and leak, the clamp cylinder could lose pressure and drop the pile.



# **OPERATION / MAINTENANCE MANUAL**

**MODEL 50 AUGER WITH MODEL 240 POWER UNIT**

**7032 SOUTH 196th - KENT, WA. 98032 - (206) 872-0141 / FAX (206) 872-8710**

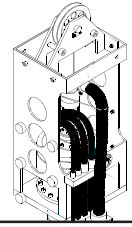

**BLANK**



# **OPERATION / MAINTENANCE MANUAL**

MODEL 50 AUGER WITH MODEL 240 POWER UNIT

7032 SOUTH 196th - KENT, WA. 98032 - (206) 872-0141 / FAX (206) 872-8710

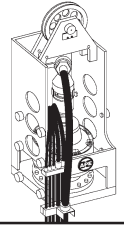

## **V. MAINTENANCE**

### **V-1. Daily Maintenance Required Prior to Operation.**

- 1.) Visually inspect the entire auger for loose nuts or bolts, including the bolts that fasten the drill motor to the drill housing. Put a wrench on the bolts and check them for tightness.
- 2.) Grease the lifting sheave, grout swivel and lead guide rollers on drill.
- 3.) Check the locking plate to insure that it is bolted down and bolts are tight.
- 4.) If the oil is milky or black then change it. **Change the oil every 75 hours regardless.**
- 5.) Check the fluid level in the power unit hydraulic tank.
- 6.) Look at all the hoses. Check for cuts or other damage that might cause an oil leak.
- 7.) Check the rubbers in the suppressor housing. Look for cracks.
- 8.) Perform all start up checks as per the "start-up procedures" in the Power Unit manual.

### **V-2. Checklist After Power Unit Engine Has Started**

- 1.) Check all hydraulic hoses for leaks. Make sure they hang free with no kinks.
- 2.) Check inside the Power Unit. Look at all hoses and valves, check for leaks.
- 3.) Check filter indicator with engine running at full rpm. Replace if necessary.
- 4.) Check wire rope sling and make sure it is in excellent condition.
- 5.) Check jaws for wear. Replace if necessary.
- 6.) Close jaws, make sure clamp light comes on.

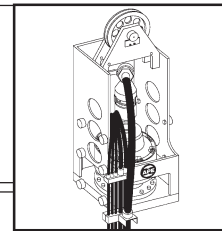

### V. MAINTENANCE (Continued...)

#### V-3. Coupling Maintenance.

Shrink Discs are supplied ready for installation. However, prior to tightening of locking screws it is necessary to remove wooden spacers located between outer collars, which are used during shipment of Shrink Discs.

#### INSTALLATION

##### Important:

Never tighten locking screws before shaft installation, since inner ring of Shrink Discs as well as hub can be permanently contracted even at relatively low tightening torque.

1. Clean hub O.D. and Shrink Disc bore and lightly lubricate hub O.D. before assembly of Shrink Disc on hub.

2. Carefully clean shaft and hub bore from any lubricant prior to mounting hub onto shaft. **THIS STEP IS VERY IMPORTANT**, since it will greatly affect the torque transmitting capability of a Shrink Disc connection.

3. After checking correct position of Shrink Disc and hub, hand tighten 3 or 4 equally spaced locking screws and make sure that outer collars of Shrink Disc are in a parallel position. Afterwards hand tighten rest of locking screws.

4. Use torque wrench and equally tighten all screws one after another in a clock or counter-clockwise sequence by approx. 1/4 turns (even if initially some screws will require a very low tightening torque) until specified tightening torque  $M_A$  is reached.

**NOTE:** To compensate for bolt setting during installation, a 5% higher than specified tightening torque is recommended for final tightening round.

5. Reset torque wrench and make sure that no screw will turn at specified tightening torque  $M_A$ .

**Figure 5-A. Coupling Components**

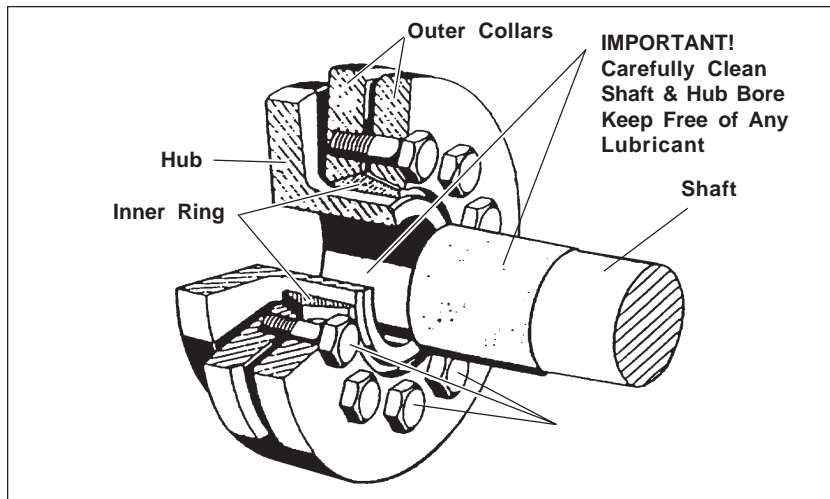

**NOTE:** It is not necessary to check tightening torque again after installation is completed or equipment has been in operation.

#### REMOVAL

1. Loosen locking screws in several stages by using approx. 1/2 turns, following either a clock or counter-clockwise sequence till Shrink Disc can be moved on hub. **DO NOT** Remove locking screws completely.

2. Make sure any rust build up in front of hub is removed before hub is pulled from shaft.

#### RE-INSTALLATION OF SHRINK DISC

In relatively clean operating conditions, Shrink Discs can be re-used without prior cleaning. Severe conditions, however, require thorough cleaning and re-lubrication with the following or similar lubricants:

Tapers of inner rings and outer collar bores:

Molykote 3321 R-spray or Molykote G RAPID-spray or paste

Screw threads and head contact area:

Multipurpose grease like Molykote BR-2

**LOCKING SCREW-TIGHTENING TORQUES "MA"**

screw size	M5	M6	M8	M10	M12	M16	M20	M24	M27
mm	8	10	13	17	19	24	30	36	41
$M_A$ [Nm]	5	12	30	59	100	250	490	840	1250
$M_A$ [ft.-lbs]	3.6	8.7	22	44	74	185	362	620	922

**Table 5-A. Torque Specifications**



# OPERATION / MAINTENANCE MANUAL

MODEL 50 AUGER WITH MODEL 240 POWER UNIT

7032 SOUTH 196th - KENT, WA. 98032 - (206) 872-0141 / FAX (206) 872-8710

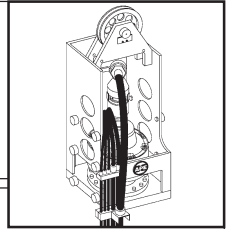

## V. MAINTENANCE (Continued...)

### V-4. Gearbox Maintenance.

**HUB CITY PUMP DRIVE MODELS** - These Instructions apply to all HUB CITY Pump Drives. Examples: 751F, 762C, **763F**, 772E, 801E, 802C, 803C, 804F.

#### LUBRICATION

ALL PUMP DRIVE UNITS ARE SHIPPED DRY. **OIL MUST BE ADDED PRIOR TO OPERATION.**

All HUB CITY Pump Drives are splash lubricated. Figures 1A show standard mounting positions. The quantity of lubricant required for operation will vary depending on the speed and position the unit is mounted. For most mounting positions approximately one-third of the cavity should be filled.

**BEFORE OPERATING:** Remove breather plug (B Fig. 1A) and oil level plug (O Fig. 1A). Note: Oil level plug is omitted on units equipped with oil level sight gauge (801, 802, 803 and 804). Clean threads on removed plugs and plug holes with degreaser. Fill unit with an approved lubricant to oil level plug or until lube is visible in sight gauge. Install plugs securely in gear case. **Note:** Plug with breather must be installed in uppermost hole of pump drive.

The quantity of lubricant required for operation will vary depending on the speed of operation. Input shaft speeds below 1000 RPM require more oil to assure complete lubricant coverage. Speeds approaching the 2400 RPM maximum may require somewhat less oil to reduce the heat generated from splashing. Operating temperatures as high as 200°F will not damage the unit, providing proper lubrication is maintained.

For operation in ambient temperatures between 40°F and 1000°F. we recommend using any standard brand GX90 Extreme Pressure lubricant such as: Mobil GX90, Texaco Marafak Multi-Gear 90, or equivalent that conforms to specification Mil-L-2105 Below 400°F, SAE #80 Gear Oil is recommended, Ambient temperatures above 100°F may require SAE #120 Viscosity Gear Oil. The factory cannot assume responsibility for damages caused by inadequate lubrication or maintenance. The operator or maintenance engineer must provide adequate lubrication for any gearbox installation by checking speed and temperature rise in operation.

**HUB CITY SYNTHETIC LUBRICANT** is a premium gearbox lubricant which is recommended for gear drives in most applications, especially those subject to low start up temperatures and/or high operating temperatures. This lubricant is a synthesized hydrocarbon based material which provides longer lubrication intervals because of its increased resistance to thermal and oxidative degradation. This decreases maintenance costs. Further economy is realized because of the increased efficiency of units lubricated with HUB CITY SYNTHETIC LUBRICANT. This lubricant can be operated at temperatures considerably above 225°F (1070°C). However, the factory should always be contacted prior to operating at high temperatures as damage may occur to seals or other components. Lubricant manufacturer and HUB CITY should be contacted when substituting a premium lubricant where HUB CITY SYNTHETIC is recommended.

**OPERATING POSITIONS** - Normal Pump Drive positions are shown in Figures 1-4. For special applications, mounting position may be changed. However, if the position varies more than 15°, it may be necessary to make some adaptations to maintain a sufficient oil level. Contact your local distributor or HUB CITY for recommendations. Input rotation of Pump Drives can be either clockwise or counterclockwise. Because of varying requirements, mounting hardware is not supplied with this unit. Good quality cap screws with lock washers should always be used.

**SHAFT (INPUT DRIVES)** - Flexible couplings to input shafts are recommended because they minimize bearing and gear wear caused by slight misalignment. Follow coupling manufacturer's recommendations for installation.

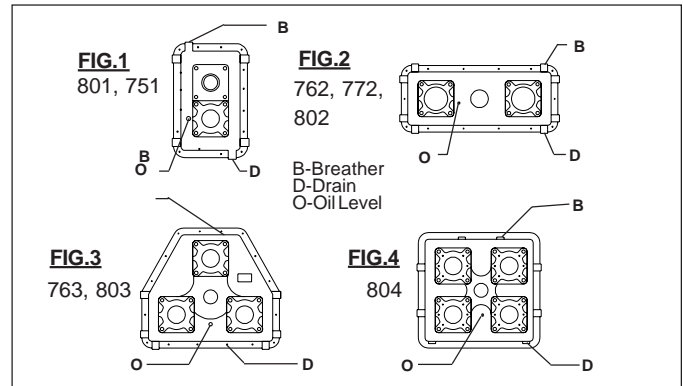

**SHEAVES AND SPROCKETS** - When mounting sheaves or sprockets, the center of the load should be as close to the drive as possible. Excessive overhung loading could result in early failures of bearing or shaft. Refer to the factory or contact your local distributor for overhung load ratings.

If any noticeable resistance is encountered when installing sheaves or sprockets on shafts, inspect components for paint, burrs or imperfections and remove. Force fitting can easily damage gears, shafts and bearings.

**DIRECT COUPLED DRIVES** - Inspect engine flywheel and flywheel housing to insure compliance to SAEJ620 and 617C. Clean flywheel face, pilot bore and flywheel housing face and inspect for burrs, damaged threads, etc. Remove and repair as required. Inspect drive plate and flywheel housing on pump drive to insure acceptance by engine flywheel and flywheel housing. Check drive plate fit on input shaft of pump drive. This must be an easy slip fit. Apply light film of Molykote G-N or similar lubricant to pilot bore on flywheel and on internal splines of drive plate. Install drive plate pilot into flywheel bore. Drive plate must fit freely until driveplate contacts flywheel. Install lockwashers and bolts through drive plate and into flywheel. Use lockwashers and bolts per Engine Manufacturer specifications. Torque bolts to manufacturer specifications. Re-check bolt length to insure drive plate is securely held to flywheel. Too long a bolt will allow threads to "bottom out" in flywheel resulting in a loose drive plate that could result in catastrophic failure. Line up splines on input shaft of pump drive with internal splines on the drive plate and insert until flywheel housing of pump drive is firmly seated against flywheel housing on engine. Install bolts and lockwashers and torque Per Engine Manufacturer specifications. Install pump(s) and all required piping, hoses, etc. Fill drive to proper level with lubricant.

**CLUTCH COUPLED DRIVES** - Inspect engine flywheel and flywheel housing to insure compliance to SAEJ620 and J617C. Clean flywheel face, pilot bore and flywheel housing face and inspect for burrs, damaged threads, etc. Remove and repair as required. Inspect drive ring, clutch teeth and clutch housing on pump drive to insure acceptance by engine flywheel and flywheel housing. Install pilot bearing on clutch shaft. Apply force to the inner race of the pilot bearing during installation. Do not press pilot bearing all the way onto the shaft. Leave .06" between front of pilot bearing and end of shaft. Install driving ring on engine flywheel and secure with bolts per engine manufacturer's specifications. Install pump drive on engine, carefully aligning pilot bearing in the flywheel bore and engaging clutch teeth with driving ring. Install bolts and lockwashers and torque per engine manufacturer's specifications. Install pump(s) and all required piping, hoses, etc. Fill pump drive to proper with lubricant.

**PREVENTATIVE MAINTENANCE** - Keep shafts and vents clean to prevent foreign particles from entering seals or gear case. Inspect periodically for oil leaks. Check drive mounting bolts for tightness, Check end play in shafts. Noticeable movement might indicate service or parts replacement is necessary.

**HUB CITY** has Sales Offices and a network of Industrial Power Transmission Distributors that can serve your needs world wide. Check the Yellow Pages for one near you or contact the factory sales office.



# OPERATION / MAINTENANCE MANUAL

MODEL 50 AUGER WITH MODEL 240 POWER UNIT

7032 SOUTH 196th - KENT, WA. 98032 - (206) 872-0141 / FAX (206) 872-8710

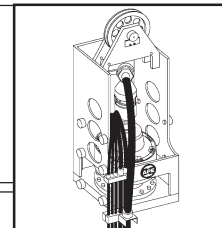

## V. MAINTENANCE (Continued...)

### V-5A. Power Unit - Filters, Fluid Types and Capacities. (Table 5-A.)

## FILTERS

LOCATION	ENGINE	FILTER TYPE	QUANTITY
Engine Oil:	CAT Engines	CAT 1 R0716	2 each
	Cummins L10	Cummins #3318853	1 each
Engine Fuel:	CAT 3408T	CAT 1 R0712	1 each
	Cummins L10	Cummins #3315843	1 each
Air Filter:	CAT Engines	CAT 4N0015	1 each
	Cummins L10	Cummins #256837	1 each
Hydraulic Oil Filters:	-----	Pall 750OSDS8H	2 each
Hand Pump Filter:	-----	Fairley Arlon FA35-10	1 each

## ENGINE OIL TYPES AND CAPACITIES

LOCATION	ENGINE	OIL TYPE	CAPACITY
Hydraulic Oil-Main:	-----	Mobil EAL 224 Veg.	300 gallons
Hyd Oil-Reserve:	-----	Mobil EAL 224 Veg.	55 gallons
Engine Oil:	CAT Engines	CAT 15W40	48 quarts
	Cummins L10	SAE 15W40	40 quarts
Engine Water:	-----	50/50 Water/Gyicol	27 gallons
Fan Drive:	-----	Multi-Purpose Grease	
Governor Control:	-----	Multi-Purpose Grease	
GearBox:	-----	Mobil Gear 626	

See small sight glass in center of gearbox between hydraulic motors. Oil should be filled to this level. Change every six months.



# **OPERATION / MAINTENANCE MANUAL**

MODEL 50 AUGER WITH MODEL 240 POWER UNIT

7032 SOUTH 196th - KENT, WA. 98032 - (206) 872-0141 / FAX (206) 872-8710

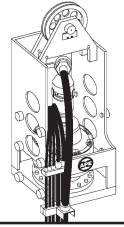

## **V. MAINTENANCE (Continued...)**

### **V-5B. Power Unit - Hydraulic Fluid.**

When adding or changing hydraulic fluid APE uses only Mobil 224 Hydraulic Vegetable oil which is non-toxic and will not harm oil or water and is biodegradable. Consult your local oil supplier for recommendations on mixing hydraulic oils. Change hydraulic oil if it looks milky. This includes all hydraulic lines leading to and from the vibro. Milky oil indicates that water is in the oil.

### **V-5C. Power Unit - Draining and Filling Hydraulic Fluid Tank**

1. Remove plug located on bottom of tank
2. Refill by manually pumping with hand crank.
3. Prime both the clamp and the main pump before restarting.
4. Take extreme caution that no dirt or other unwanted particles enters the system.

### **V-5D. Power Unit - Cleaning Hydraulic Tank Suction Filter.** (No suction on 1993 and newer)

1. Located inside the hydraulic tank or reservoir, is a suction filter.
2. Drain tank.
3. Remove side cover.
4. Reach into to and unscrew filter from pipe fitting.
5. Clean with solvent and re-install. If damaged then replace.
6. Re-install filter.
7. Re-install tank cover.
8. Add new oil to tank.
9. Prime pumps.



# **OPERATION / MAINTENANCE MANUAL**

MODEL 50 AUGER WITH MODEL 240 POWER UNIT

7032 SOUTH 196th - KENT, WA. 98032 - (206) 872-0141 / FAX (206) 872-8710

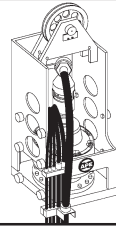

## **V. MAINTENANCE (Continued...)**

### **V-5E. Power Unit - Changing Hydraulic Return Filter Element.**

The hydraulic return filter is mounted on the hydraulic tank inside the power unit. It is mounted high on the tank so that when the filter element is removed the oil will not drain from the hydraulic tank. The filter has a manual pop-up type indicator to tell when the filter is dirty. The pop-up indicator turns red when it is in the dirty position.

### **V-5F. Power Unit - Steps to Remove the Element.**

1. Shut down power unit by turning off the diesel engine.
2. Place warning tag on control panel so that no one mistakenly starts the unit while filters are being changed.
3. Clean area around filter so that when it is removed there is no chance of introducing dirt into the hydraulic system.
4. Using a filter wrench, turn the filter counter clockwise and spin the filter off the filter housing.
5. Install new clean filter making sure the o-ring is in place.
6. Depress filter indicator to re-set to "clean position".





# OPERATION / MAINTENANCE MANUAL

MODEL 50 AUGER WITH MODEL 240 POWER UNIT

7032 SOUTH 196th - KENT, WA. 98032 - (206) 872-0141 / FAX (206) 872-8710

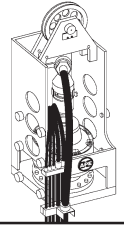

## VI. MODEL 50 AUGER TROUBLE-SHOOTING

The following table lists some possible problems, causes, and solutions. If a serious problem should occur, contact the factory for additional service information.

**Table 6-A. Auger Trouble-Shooting Index**

ITEM	PROBLEM	ITEM	PROBLEM
1.	Auger Won't Start When Start Button is Engaged.	4.	Loaded Motor Doesn't Turn At Normal Speed.
2.	Auger Won't Turn When Forward/Reverse Button is Engaged.	5.	Motor Turns Irregularly.
3.	Noisy Motor.	6.	External Oil Leaks.

### Possible Cause

### Remedy

#### 1. Auger Won't Start When Start Button is Engaged.

Diesel engine is not running.	Start diesel engine.
Start relay contacts may not be closing.	Press and hold the Start Button on the pendant. If auger starts, replace Start Relay.
Hoses may be connected improperly.	Check hoses and make connection corrections if required.
Drive pressure is too low.	Manually close start valve at the drive manifold. If auger will not start, replace the start valve. If auger still will not start, replace the drive pump.

#### 2. Auger Won't Turn When Forward/Reverse Button is Engaged.

Diesel engine may not be running.	Start the power unit engine and allow pressure to build.
There may be an electrical failure.	Check for the following: - Defective forward/reverse switch. - Broken or loose wire in the pendant or pendant cable. - Defective OPEN solenoid. - Broken or loose wire between main power switch and START relay. - Broken or loose wire between main power switch and amphenol connector.

#### 3. Noisy Motor.

Unloaded: Regular Hum.	Worn bearings. Check and replace if necessary.
Vibrations.	Loose mountings or pipes. Tighten to torque.
Loaded: Banging sounds.	Boost pressure too low. Check the return pressure and check for corrosion of the back-pressure valve.
Popping Sounds.	Serious leaks. Check the cylinder block and/or distributor assemblies.



# **OPERATION / MAINTENANCE MANUAL**

MODEL 50 AUGER WITH MODEL 240 POWER UNIT

7032 SOUTH 196th - KENT, WA. 98032 - (206) 872-0141 / FAX (206) 872-8710

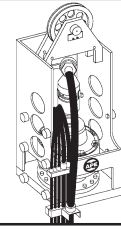

## **VI. AUGER TROUBLE-SHOOTING (Continued...)**

### **Possible Cause**

### **Remedy**

#### **4. Loaded Motor Doesn't Turn At Normal Speed.**

Insufficient flow

Check pump flow and speed of rotation.

Serious leaks.

Check the cylinder block and/or distributor assemblies.

Pressure too low

Check the relief valve setting.

#### **5. Motor Turns Irregularly.**

Irregular flow.

Check the pump flow.

Serious leaks.

Check the cylinder block and/or distributor assemblies.

#### **6. External Oil Leaks.**

Motor casing pressure too high

Check the leakage line filter.  
Check that the leakage line is not blocked.

Seals damaged by pressure peaks, elevated operating temperature, use of fluid not approved, incompatible with seal material, or polluted with contaminants.

Check and replace where needed.

Defective assembly.

Check and torque assembly bolts.



# **OPERATION / MAINTENANCE MANUAL**

**MODEL 50 AUGER WITH MODEL 240 POWER UNIT**

7032 SOUTH 196th - KENT, WA. 98032 - (206) 872-0141 / FAX (206) 872-8710

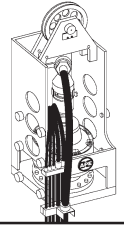

## **VII. MODEL 240 POWER UNIT**

### **VII-1. Hydraulic Circuitry.**

The following are descriptions of the components that make up the Hydraulic Circuitry of the APE Model 240 Power Unit.

#### **VII-1A. Warming Hydraulic Fluid.**

The drill can handle very low temperatures. However, the pumps on the power unit may cavitate if the oil is so cold that it cannot gravity feed to the pumps. For this reason, starting the engine when the oil is below 30 degrees is asking for problems. Please replace the oil with a suitable oil for cold temperatures if the area you are working in is below 30 degrees. Consult factory or your local hydraulic oil supplier.

#### **VII-1B. Drive Circuit.** (Used for operating APE vibrator, APE drill, or any other unit).

There are three pumps, items #13 and 14, that direct oil to the drive circuit (Vibro Motors). The maximum drive pressure is controlled by the drive pressure relief valve, item #26, to 5000 psi. max. When the drive switch is moved to the forward position, solenoid "A" of the drive directional control valve is energized, item #29. Oil flow is directed to the vibro motors to rotate the eccentrics. When the drive switch is moved to the off position, oil flow is directed back to the tank through the drive directional control valve and solenoid "A" is de-energized. Because of the high oil flow in the drive circuit, APE, Inc. has developed a circuit that eliminates high shock loads. Items #27, 31 & 33 are small internal components located in the drive manifold that provide a soft shift feature for the drive directional control valve. Item #27 is a small adjustable snubber valve, item #31 is a small shuttle valve and items #33 are small fixed orifices. The orifices, items #33 are used to dampen the shifting of item #29. This provides a soft start/stop of the drive directional control valve, preventing hydraulic shock to the drive system. The shuttle valve, item #31 is used to send a hydraulic signal to the drive pressure relief valve item #26, when the drive directional control valve is centered or de-energized. This hydraulic signal tells the drive pressure control valve to open and allow any high flow, high pressure, back to tank. The snubber valve, item #27, simply controls how fast this signal is received by the drive pressure relief valve, item #26. The drive pressure can be read on the drive pressure gauge, item #15. Item #25 is the oil temperature control valve that directs oil flow to the oil cooler, item #24, when oil temperature increases.

The quick disconnect couplings, (QD #35 & #36) permit de-coupling of the drive and case drain hoses at the power unit.



# OPERATION / MAINTENANCE MANUAL

MODEL 50 AUGER WITH MODEL 240 POWER UNIT

7032 SOUTH 196th - KENT, WA. 98032 - (206) 872-0141 / FAX (206) 872-8710

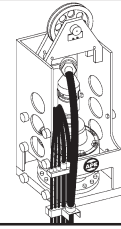

## VII. MODEL 240 POWER UNIT (Continued...)

### VII-1C. Return Filter.

Returning fluid is filtered by the return filter items #21 & #22.

### VII-1D. Oil Cooler.

The oil cooler, item #24, cools the hydraulic fluid returning from the vibrator.

### VII-1E. Manual Pump.

A manual pump, item #10, is provided to fill the hydraulic reservoir. A hand valve, item #11, prevents loss of fluid from the reservoir back through the manual pump.

### VII-1F. Hydraulic Oil Temperature.

A temperature gauge, item #15, indicates hydraulic oil temperature. The sending unit is mounted on the outboard side of the oil cooler or heat exchanger just behind the control panel and accessed through the swinging front door.

### VII-1G. Hydraulic Components. - Table 7-A.

ITEM	QTY	DESCRIPTION	PARTNUMBER	MFG.	APE, P/N
1	1	Air Breather	#ABG-10	LHA	#513002
2	1	Sight Gauge	#G607-06-A-MOD w/Polycarb	Lube Devices	#513003
3	1	Ball Valve	#70-106 1 1/4"	Appollo	#513004
4	1	Sight Gage	#G607-30-A-1-4-MOD w/Polycarb	Lube Devices	#513006
5	1	Temperature Gauge	#K2555 30-250 F	Marsh	#511044
6	1	Ball Valve	#77-105-1"	Appollo	#513005
7	1	Pressure Gauge	#771-0-600-2.5" LBM-SG	ENFM	#513007
8	1	Ball Valve	#77-105-1"	Appollo	#513008
9	3	Ball Valve	#77-108-2"	Appollo	#533009
10	1	Hand Pump	#PA-414	Blackmer	#513010
11	1	Check Valve	#61-105	Appollo	#513011
12	1	Hyd. Pump	#F11-19-RUSH-S	Volvo	#513012
13	2	Hyd. Pump	#F12-80-LSSH-S	Volvo	#533012
14	1	Hyd. Pump	#F12-60-LSSH-S	Volvo	#513013
15	1	Pressure Gauge	#771-0-6000-2.5" LBM-SG	ENFM	#513014
16	1	Clamp Manifold	#D-14605	PFS	#523002
17	1	P.O. Check Valve	#0-811-020-016	Bosch	#513016
18	1	Colntrol Valve Clamp NG10 4/3 00 24DC DIN	#0-810-001-708	Bosch	#513017
19	1	Relief Valve NG10	#0-811-101-170	Bosch	#513018
20	1	Check Valve	#CXDA-XCN	Sun Hydraulics	#513019
21	1	Filter (Fill)	#HH7400B12DSRAPL	Pall	#513020
22	1	Return Filter	#HH7502B32DSSBPL	Pall	#513021
23	1	Check Valve	#CV-14P-5 1 1/4"	LHA	#513022
24	1	Hyd. Cooler	#DB-2297	Durn Bush	#533023
25	1	Thermostatic Valve	#2B0CT12001	AMOT	#513024
26	1	NG25 Relief Valve	#0-811-102-70	Bosch	#513025
27	1	Snubber Valve	#NSAB-KXV-BA	Sun Hydraulics	#513026
28	1	Drive Manifold	#D-15190	PFS	#513027
29	1	NG25 Control Valve 4/3-00-24VDS DIN	#0-810-010-722	Bosch	#513029
30	1	Gearbox 1:1 Ratio	#763F Special (Model 325) #803F Special (Model 500)	Hub City	#532001
31	1	Shuttle Valve	#CSAA-EXN-GBS	Sun Hydraulics	#513030
32	1	Check Valve	#1-817-419-038	Bosch	#513031
33	3	Pilot Restrictor	#1-810-120-009	Bosch	#513032
34	1	Pressure Switch, 8 KPSI	#OE4-SBHS-8K	Oildyne	#700017
35	1	Disconnect Male/Female	#400100	APE, INC. MFG.	#400100
36	1	Disconnects	#5100-S5-12B	Aeroquip	#421019
37	2	Disconnects	#6-S30-3	Safeway	#421023
38	1	Level Switch	#L120	Murphy	#513033
39	1	Pressure Switch	#771-0-6000-2.5" LBM-SG	ENFM	#513034
40	1	Check Valve 1/4" NPT	#23491B-2MP	Circle Seal	#513035

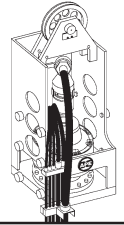

### VII. MODEL 240 POWER UNIT (Continued...)

#### VII-1H. Hydraulic Schematic.

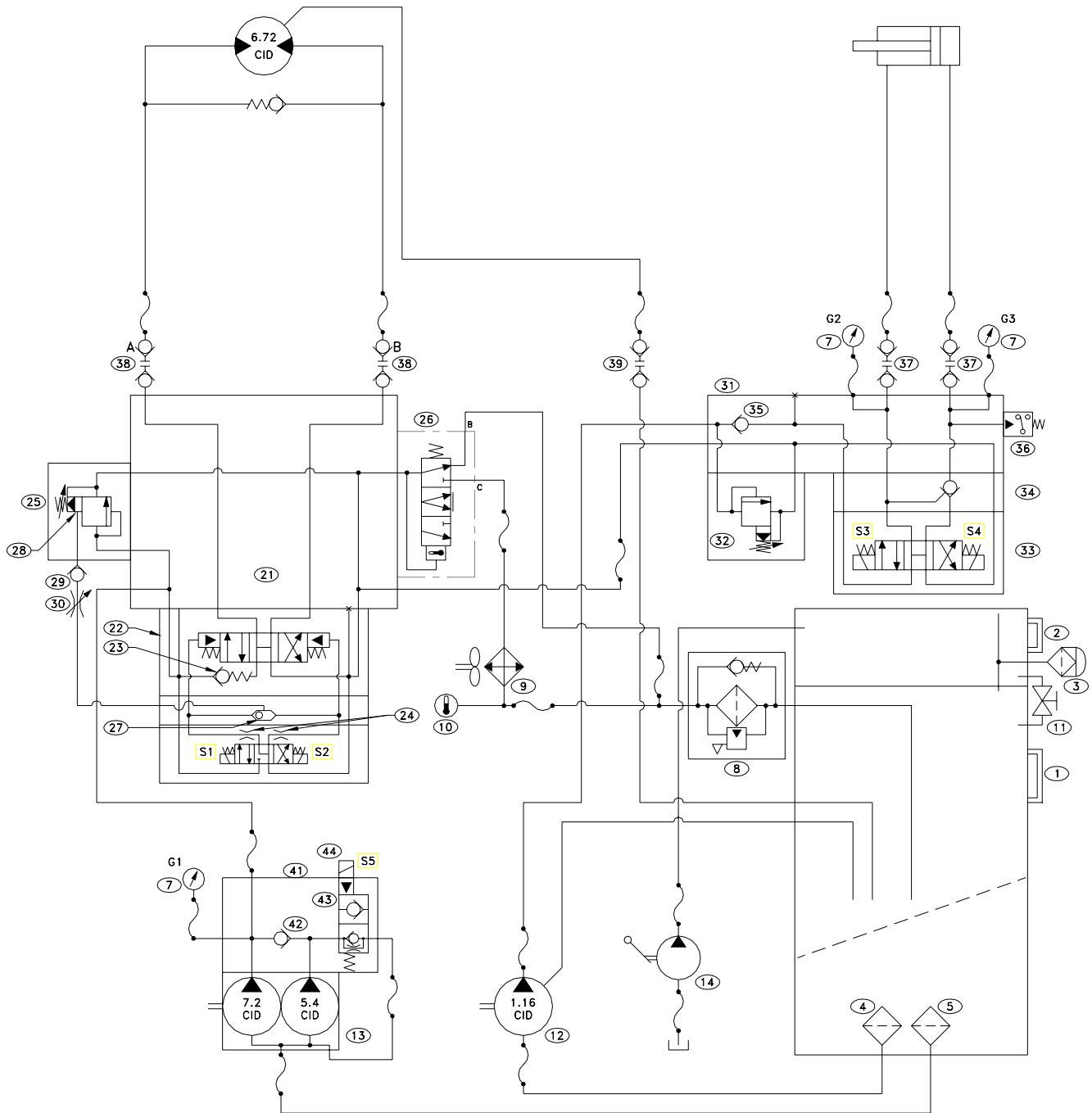

**Figure 7-A. Power Unit Hydraulic Schematic.**



# **OPERATION / MAINTENANCE MANUAL**

MODEL 50 AUGER WITH MODEL 240 POWER UNIT

7032 SOUTH 196th - KENT, WA. 98032 - (206) 872-0141 / FAX (206) 872-8710

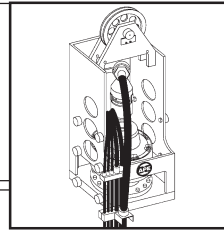

## **VII. MODEL 240 POWER UNIT (Continued...)**

### **VII-2. Electrical Circuitry.**

The following are descriptions of components that make up the Electric Circuitry of the APE Model 240 Power Unit.

#### **VII-2A. Diesel Engine.**

The HYDRAULIC POWER UNIT is powered by a 4 stroke compression ignition diesel engine. Two 12 volt (4D) batteries provide 24 volts for starting the engine and running the electrical controls.

#### **VII-2B. Controls: (Understanding How They Work).**

##### **1. Engine Control Switch "OFF/ON/START"**

The ENGINE CONTROL SWITCH is used to start and stop the diesel engine. Turning it to "ON" turns on all power to the panel. Turning to START energizes the engine starter solenoid which activates the starter motor which turns the diesel engine flywheel and causes the engine crankshaft to turn which, through various mechanical actions, acts on the fuel pump. As the engine turns, the fuel pump injects fuel into the combustion chamber of each piston cylinder at timed intervals and as the engine continues to crank, fuel and air is compressed in the combustion chamber by each piston as it comes up on the compression stroke. As the pistons compress fuel and air, the fuel and air mix into a combined gas that ignites under pressure when each piston nears the top of its stroke the gas explodes, forcing the piston downward and converts thrust into torque via a connecting rod pinned to the piston and mounted to a crankshaft. When the piston reaches the bottom of the cylinder, it begins its upward travel and an exhaust valve at the top of the cylinder opens, forcing unburned gases out. When the piston reaches the top, the exhaust valve closes and an intake valve opens as the piston travels back downward. The piston sucks new air into the combustion chamber while the fuel injector adds fuel. These four cycles of intake, compression, ignition and exhaust continue until the engine fuel delivery is cut off.

Once the engine is rotating on its own power, the switch is released. The switch returns to the "ON" position because it is spring loaded in that direction. To turn the engine off, the switch is turned to the "OFF" position, which sends a grounded signal that activates the ENGINE SAFETY SHUT DOWN SWITCH which then cuts power to the fuel solenoid and stops the engine.

##### **2. "LOCAL/REMOTE" Switch.**

The LOCAL/REMOTE SWITCH is used to allow the operator to control the power unit from either the CONTROL PANEL or the REMOTE HAND HELD PENDANT. The LOCAL / REMOTE SWITCH must be in the LOCAL position to start the engine.



# **OPERATION / MAINTENANCE MANUAL**

**MODEL 50 AUGER WITH MODEL 240 POWER UNIT**

7032 SOUTH 196th - KENT, WA. 98032 - (206) 872-0141 / FAX (206) 872-8710

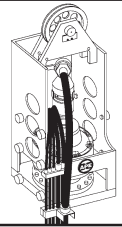

## **VII. MODEL 240 POWER UNIT (Continued...)**

### **VII-2B. Controls: (Understanding How They Work). (Continued...)**

#### **3. Clamp "OPEN/OFF/CLOSE" Switch. (For Vibratory Hammer Only).**

The CLAMP OPEN/OFF/CLOSE SWITCH is used to control the direction of the hydraulic flow coming from the clamp pump. When the engine is running and the switch is in the "OFF" position, all clamp PUMP oil is returned to the tank. Turning the CLAMP CLOSE/OFF/OPEN SWITCH to the close position energizes the clamp close solenoid, which can be observed with the lighted connector. When the close solenoid energizes, the clamp close valve closes sending hydraulic oil to the closed side of the clamp cylinder. When the pressure reaches 4000 psi, the CLAMP PRESSURE SWITCH (located on the clamp manifold) opens, de-energizing the closed solenoid and lighting a lamp in the CLAMP OPEN / OFF / CLOSE SWITCH and the green lamp on the remote HAND HELD PENDANT. If the pressure drops below 3800 psi, the CLAMP PRESSURE SWITCH closes allowing the close solenoid to recharge the clamp close hydraulic circuit. Note: If the light on the solenoid stays on and the green light on the pendant fails to come on then the pressure switch may be faulty. Do not operate the machine if you can see the clamp closed solenoid light on all the time. (Note: the clamp closed solenoid light is located on the solenoid.) It should go off as soon as the jaws close and the pressure rises above 3800 psi. When jaws are closed properly, the green light will glow on the remote pendant, or if operating from the panel, the green light is built into the switch. When the diesel engine is running, Turning the clamp switch to "OPEN" energizes the open solenoid and directs oil to the open side of the clamp cylinder and the jaws open.

#### **4. Drive "FORWARD/REVERSE" Switch. (For Auger Operation).**

The DRIVE FORWARD/REVERSE SWITCH is used to control the hydraulic motors on the vibrator or for supplying forward and reverse direction on a drill. With the engine running and the DRIVE FORWARD / REVERSE SWITCH in the forward position, the forward drive solenoid energizes, which can be observed with the lighted connector. With the forward drive solenoid energized, the forward valve opens, sending hydraulic fluid to the hydraulic motors, and the motors rotate. With the engine running and DRIVE FORWARD/REVERSE SWITCH in the reverse position, the reverse drive solenoid energizes, which can be observed with the lighted connector. With the reverse drive solenoid energized, the reverse valve sends oil to the vibrator motors but the motors do not rotate because all oil flow is directed around the motors via the ANTI-CAVITATION CHECK VALVE located on the vibro suppressor housing and plumbed into the hoses leading to and from the hydraulic motors. Therefore, the vibrator runs in the forward direction only, and this direction is used for driving or pulling all piles. The reverse direction is used when the power unit is supplying oil to a drill or other attachment or when flushing the oil during initial startup.

#### **5. "SYSTEM OK" Light.**

The "SYSTEM OK" Light is lighted when the engine is running and all systems are normal.

#### **6. "SPARE" Light.**

Some power units have a spare light on the panel. It is not used.



# **OPERATION / MAINTENANCE MANUAL**

MODEL 50 AUGER WITH MODEL 240 POWER UNIT

7032 SOUTH 196th - KENT, WA. 98032 - (206) 872-0141 / FAX (206) 872-8710



## **VII. MODEL 240 POWER UNIT (Continued...)**

### **VII-2B. Controls: (Understanding How They Work). (Continued...)**

#### **7. Throttle "RAISE/OFF/LOWER" Switch.**

This switch is used to throttle the engine up or down. This switch turns a small motor hooked to the engine throttle. APE power units with CAT engines use a system supplied by CAT. The CAT engine throttle requires two small relays mounted inside the control panel. The APE units with Cummins engines do not have relays and are wired directly to a Murphy worm drive throttle box mounted on the engine.

#### **8. "OIL PRESSURE" Gauge: (CAT Engines Only - Older Power Unit Models!)**

An electric "OIL PRESSURE" Gauge is provided to monitor engine oil pressure. The CAT oil pressure gauge is wired to an oil pressure sender that forces the gauge to read zero pressure when the power is turned on. The CAT sender is a variable resistor that is normally grounded and slowly decreases the grounded voltage as pressure is delivered to it. As the voltage decreases, the pressure gauge reading increases. To test the sender, disconnect the wire leading to it and place one OHM meter lead on the sender terminal and the other lead on the engine. It should show maximum resistance. If not, replace it. (CAT ONLY).

#### **9. "ENGINE OIL PRESSURE" Gauge: (CUMMINS Engines)**

The engine oil pressure gauge on the Cummins engine is wired to a variable resistor that goes from zero resistance when not pressurized to full resistance when at maximum pressure. When the power switch is turned on the gauge reads zero. When the engine is started the engine oil pressure increases and the variable resistor begins to ground out as engine oil pressure pushes on it. If the gauge continues to read zero, the sender may be faulty. To test the sender, disconnect the wire from the pressure gauge and place one lead of the OHM meter on the sender terminal and the other lead on the engine. OHM meter should read zero resistance. If OHM meter shows resistance then replace it.

#### **10. "ENGINE OIL PRESSURE" Switch:**

A small ENGINE OIL PRESSURE Switch mounted on the diesel engine is designed to ground out when pressure drops below 40 psi. The switch is designed to be normally open when under pressure. When pressure is lost, the switch closes sending a grounded signal that activates the safety shut down switch on the panel which cuts power to the fuel solenoid and shuts down the engine.

#### **11. "WATER TEMPERATURE" Gauge:**

An electric "WATER TEMPERATURE" Gauge is provided to monitor engine water temperature.





# **OPERATION / MAINTENANCE MANUAL**

MODEL 50 AUGER WITH MODEL 240 POWER UNIT

7032 SOUTH 196th - KENT, WA. 98032 - (206) 872-0141 / FAX (206) 872-8710

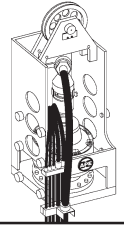

## **VII. MODEL 240 POWER UNIT (Continued...)**

### **VII-2B. Controls: (Understanding How They Work). (Continued...)**

#### **12. "WATER TEMPERATURE" Switch:**

A water temperature switch is mounted on the engine. It is a normally "open" switch. If the water temperature increases to a level that may damage the engine, the switch closes, sending a grounded signal that activates the "ENGINE SAFETY SHUTDOWN" Switch located on the panel. This switch can give a faulty signal and cause the engine to shut down even when water temperature is normal. To test the switch, disconnect the wire leading to it. Test the switch using an OHM meter by placing one OHM lead to the switch terminal and one to the grounded engine. You should not see a reading on the OHM meter (provided the water temperature is below 207 degrees F.). If the OHM meter shows resistance then replace the switch.

#### **13. "FUEL PRESSURE" Gauge:**

An electric FUEL PRESSURE Gauge is provided to monitor engine fuel pressure. An electrical variable resistor mounted on the fuel system sends a signal to the gauge. The sender is designed send a signal to the panel gauge as pressure increases which increases the gauge reading.

#### **14. "TACHOMETER"**

A "TACHOMETER" is provided to monitor the engine speed for optimum operation. The tachometer is digital and operates off a magnetic pickup that receives a signal from the flywheel of the engine. **Note:** If the tachometer seems to be reading wrong, check with a photo tach. Adjustments can be made on the back of the tachometer. Consult factory for proper setting of tach switches.

### **VII-2C. Preparing The Electrical System For Start-Up.**

To start the engine the (CIRCUIT BREAKER) should be in the "ON" position (PUSHED IN AND LOCKED) and the FORWARD/OFF/REVERSE switch both on the panel and on the pendant should be in the off position. The engine will not start if the DRIVE/OFF/FORWARD switch is in the "ON" position. This prevents the operator from accidentally starting the engine and setting the vibrator or drill into motion the moment the engine starts.

### **VII-2D. Engine Safety Shut-Down Button Switch.**

The "ENGINE SAFETY SHUT DOWN BUTTON SWITCH" turns on and off the fuel solenoid that is mounted on top of the engine. The button must be depressed in order to get power to the fuel solenoid and allow the engine to receive fuel to the fuel pump. Three safety switches: (1. Water Temperature, 2. Engine Oil Pressure and 3. Hydraulic oil level) on the power unit are wired into the "ENGINE SAFETY SHUT DOWN BUTTON SWITCH" and will shut the engine off automatically if any of these three switches is closed. (Please see "Engine Safety Shut-Down (Three Causes Of Engine Shut-Down)" in this manual for detailed instructions on how these switches work and read the TROUBLESHOOTING SAFETY SHUT DOWN SWITCHES in this manual to render repairs. It is very simple, please make the effort to read and understand these switches and how they work.)



# **OPERATION / MAINTENANCE MANUAL**

MODEL 50 AUGER WITH MODEL 240 POWER UNIT

7032 SOUTH 196th - KENT, WA. 98032 - (206) 872-0141 / FAX (206) 872-8710

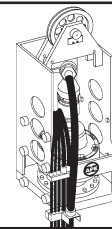

## **VII. MODEL 240 POWER UNIT (Continued...)**

### **VII-2D. Engine Safety Shut-Down Button Switch. (Continued...)**

If the button pops back out the moment you release your finger from the button, then one or more of the three shut down switches is closing and grounding the "ENGINE SAFETY SHUT DOWN SWITCH". This will happen for the described in the following section of this manual.

### **VII-2E. Engine Safety Shut-Down (Three Causes Of Engine Shut-Down).**

#### **1. No Oil Pressure:**

The engine oil pressure is used to open and hold open a small pressure switch mounted on the diesel engine. The engine oil pressure holds open the oil pressure switch as long as the engine is running and there is proper engine oil pressure. If the oil pressure drops, (NO OIL PRESSURE COULD RESULT IN A DESTROYED ENGINE) the switch closes and grounds the ENGINE SAFETY SHUT DOWN SWITCH located on the control panel which activates and cuts power to the fuel solenoid and shuts the engine down, saving the engine from possible damage due to lack of oil. Sometimes the oil pressure switch fails and sends a grounded signal to the "ENGINE SAFETY SHUT DOWN SWITCH" even when the oil pressure is fine. Please read the section titled "TROUBLESHOOTING: ENGINE OIL PRESSURE SWITCH" in this manual if you think this may have happened.

#### **2. High Engine Coolant Temperature:**

The engine coolant or engine water temperature is controlled by a temperature switch. This switch, located on the front of the engine, is normally open when the coolant temperature is normal. If the engine coolant becomes too hot the switch closes and sends a grounded signal which activates the "ENGINE SAFETY SHUT DOWN SWITCH" located on the panel. When this happens, power is cut to the fuel solenoid and the engine stops which prevents the engine from overheating and destroying itself. Sometimes this switch fails to work properly and shuts the engine down even when the water temperature is fine. Please read the section titled "TROUBLESHOOTING: ENGINE WATER TEMPERATURE SWITCH" in this manual if you think this may have happened.

#### **3. Low Hydraulic Oil Temperature:**

The hydraulic oil level in the tank is controlled by an oil level switch that is normally open when oil is in the tank at an acceptable level for operation. If the hydraulic oil level drops below the required level, the switch will close and send a grounded signal activates the "ENGINE SAFETY SHUT DOWN SWITCH" located on the panel. When this happens, power is cut to the fuel solenoid and the engine stops which prevents the hydraulic pumps from destruction due to lack of hydraulic oil. Some times this switch fails to work properly and shuts the engine down even when the oil level in the tank is normal. Please read the section titled "TROUBLESHOOTING: HYDRAULIC OIL LEVEL SWITCH" in this manual if you hink this may have happened.



# OPERATION / MAINTENANCE MANUAL

MODEL 50 AUGER WITH MODEL 240 POWER UNIT

7032 SOUTH 196th - KENT, WA. 98032 - (206) 872-0141 / FAX (206) 872-8710

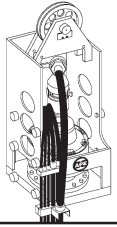

## VII. MODEL 240 POWER UNIT (Continued...)

### VII-3. Remote Control Pendant.

A "REMOTE HAND HELD CONTROL PENDANT" is provided to allow operation of the power unit at a distance of up to 50 feet (15 meters) and can be extended using 50 foot extension cables. The "REMOTE HAND HELD CONTROL PENDANT" is connected to the control panel via a multiconnector plug.

This remote can be used to check all the electrical control valves by simply disconnecting the wire to the engine oil pressure switch and pushing in the safety shut down button and then turning on the star switch to the on position. Once this is done, you can walk over to the valves while holding the pendant in your hand. As you switch the valves you can see the lighted connectors go on and off on the top of the four solenoids: clamp open, close & drive forward and reverse.

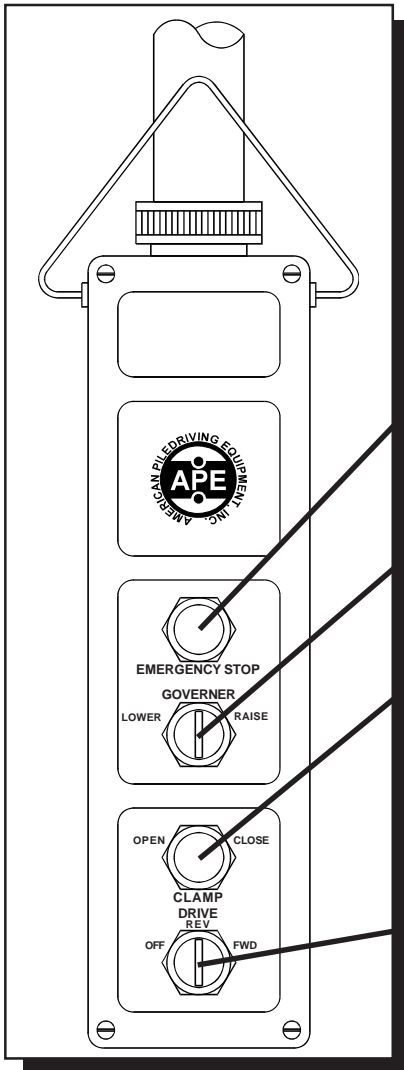

#### ENGINE EMERGENCY SHUTDOWN SWITCH:

Press and hold to shut engine off. Do not use to shut engine off at the end of shift. Shut unit off at panel at end of shift. Button is for emergency only.

#### ENGINE THROTTLE "RAISE/LOWER" RPM:

Three Position Switch. Press and hold button to raise or lower deisel engine rpm.

#### CLAMP OPEN/CLAMP CLOSE:

Lighted switch. Move to **close** to extend jaw and clamp vibro to pile. Light comes on when clamp is closed and locked. Turn to **open** to retract jaw and release vibro from pile. Switch must remain in **closed** position to hold clamp to pile. Sometimes the light will not come on. It could be burnt out or shorted. Check clamp pressure gauge and make sure it reads at least 3800 psi before vibrating any pile. Contact APE if light is not working.

#### FORWARD/OFF/REVERSE:

Three position switch. Turn to **forward** to operate vibro. Turn to **off** to stop vibro. Turn to **reverse** when using power unit to run a drill motor. Vibro is not supposed to vibrate in reverse. If it does then switch the two yellow cables labled "drive" and "reverse" located on the other side of the control panel.

**Figure 7-A. Remote Control Pendant.**

**WARNING:** Never leave vibro clamped to a pile without the crane line attached. The clamp cylinder could bleed off causing the vibro to drop. Neverhoist a pile in the air without a safety line attached to the pile. Should the clamp close line become damaged and leak, the clamp cylinder could lose pressure and drop the pile.

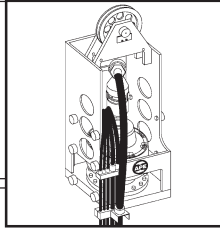

### VII. MODEL 240 POWER UNIT (Continued...)

#### VII-3A. Remote Pendant Wiring Diagram.

The following is the pin wiring configuration and the wire colors of the amphenol connectors for the remote control pendant cable.

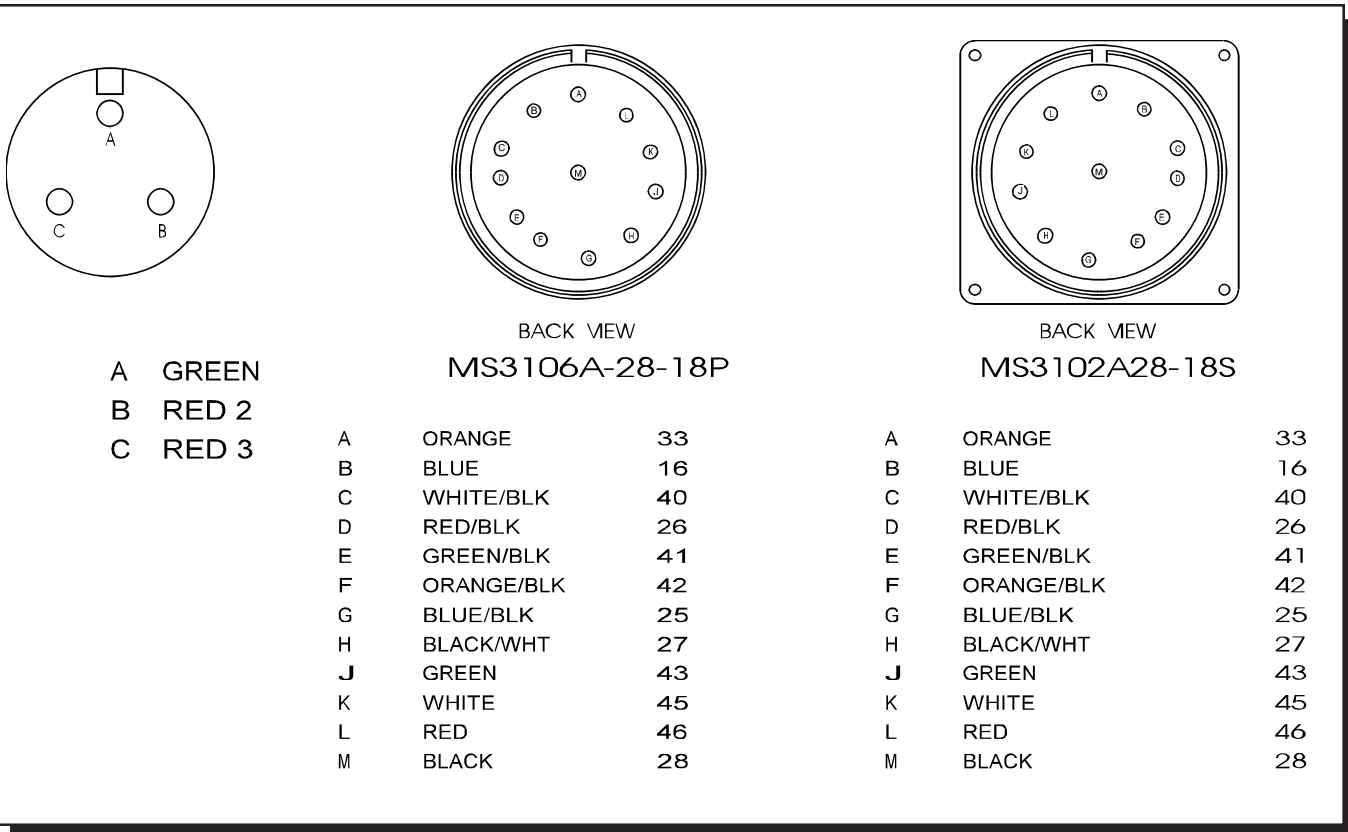

**Figure 7-D. Remote Pendant Wiring Diagram.**



# **OPERATION / MAINTENANCE MANUAL**

MODEL 50 AUGER WITH MODEL 240 POWER UNIT

7032 SOUTH 196th - KENT, WA. 98032 - (206) 872-0141 / FAX (206) 872-8710

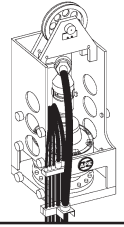

## **VII. MODEL 240 POWER UNIT (Continued...)**

### **VII-4. Troubleshooting: Power Unit Electrical.**

Use the following sections to help determine and solve problems that may arise within the power unit electrical system.

#### **VII-4A. Troubleshooting: Engine Oil Pressure Switch.**

The "ENGINE OIL PRESSURE SWITCH" is "open" when the engine is running so if this switch has shut down the engine, then it must be closing. Remove the wire from the switch and see if the engine will now run without the oil pressure switch connected. Make sure you do not have the wire that you just disconnected touching the engine or anything that could ground it. If the engine still shuts down the moment you let go of the "ENGINE SAFETY SHUT DOWN BUTTON SWITCH" then one of the other two safety switches is shutting down the engine. To test the switch, start the engine and use an OHM meter to see if the switch is open by placing one OHM meter lead on the switch terminal and the other OHM lead on the grounded engine. You should not show any resistance. If the engine is not running you should show resistance on the OHM meter because the switch will be closed. Replace switch if necessary.

#### **VII-4B. Troubleshooting: Engine Water Temperature Switch.**

The "ENGINE WATER TEMPERATURE SWITCH" is normally "open" and will only close if the water is too hot. If you think the engine has shut down because of a faulty temperature switch then remove the wire from the switch and try to start the engine again. If the engine is not running when you release your finger from the "ENGINE SAFETY SHUT DOWN SWITCH" then you have found your problem, it is the switch. To double check the switch, put one OHM meter lead on the switch and the other on a the grounded engine. OHM meter should show no reading. Replace if necessary.

#### **VII-4C. Troubleshooting: Hydraulic Oil Level Switch.**

The "HYDRAULIC OIL LEVEL SWITCH" is normally "open" when there is oil in the tank filled to the proper level. The switch is mechanically attached to a float that is submerged in the hydraulic oil tank. If the oil level drops, so does the float, and the switch will close if the oil level gets too low. It will also close if the oil level is just slightly above the float but the power unit is mounted on the back of a crane that is swinging so fast that the oil level is effected by the washing of the oil in the tank. When the switch closes, it sends a grounded signal that activates the "ENGINE SAFETY SHUT DOWN BUTTON SWITCH" located on the panel which cuts power to the fuel solenoid and shuts the engine down. The fuel solenoid must be energized to allow fuel to get to the fuel pump. If you think the "HYDRAULIC OIL LEVEL SWITCH" may be causing the engine to shut down, disconnect the wire at the float switch located on the hydraulic tank. Try to start the engine. If it runs even after you remove your finger from the "ENGINE SAFETY SHUT DOWN BUTTON SWITCH", then you have located your problem- the float switch is not working. To check, put one lead of the OHM meter on the terminal and the other lead on the ground. The meter should not show a reading. If it does, your oil is too low or the switch is bad. Replace it.



# **OPERATION / MAINTENANCE MANUAL**

MODEL 50 AUGER WITH MODEL 240 POWER UNIT

7032 SOUTH 196th - KENT, WA. 98032 - (206) 872-0141 / FAX (206) 872-8710



## **VII. MODEL 240 POWER UNIT (Continued...)**

### **VII-4. Troubleshooting: Power Unit Electrical. (Continued...)**

#### **VII-4D. Troubleshooting: Oil Pressure Sending Unit. (CAT Engines Only - Older Units)**

An electric "OIL PRESSURE GAUGE" is provided to monitor engine oil pressure. The CAT oil pressure gauge is wired to an oil pressure sender that forces the gauge to read zero pressure when the power is turned on. The CAT sender is a variable resistor that is normally grounded and slowly decreases grounded voltage as pressure is delivered to it. As the voltage decreases, the pressure gauge reading increases. To test the sender, disconnect the wire leading to it and place one OHM meter lead on the sender terminal and the other lead on the engine. It should show maximum resistance. If not, replace it. CAT ONLY.

#### **VII-4E. Troubleshooting: Oil Pressure Sending Unit. (CUMMINS Engines)**

The engine oil pressure gauge on the Cummins engine is wired to a variable resistor that goes from zero resistance when not pressurized to full resistance when at maximum pressure. When the power switch is turned on the gauge reads zero. When the engine is started the engine oil pressure increases and the variable resistor begins to ground out as engine oil pressure pushes on it. If the gauge continues to read zero, the sender may be faulty. To test the sender, disconnect the wire from the pressure gauge and place one lead of the OHM meter on the sender terminal and the other lead on the engine. OHM meter should read zero resistance. If OHM meter shows resistance then replace it.



# **OPERATION / MAINTENANCE MANUAL**

MODEL 50 AUGER WITH MODEL 240 POWER UNIT

7032 SOUTH 196th - KENT, WA. 98032 - (206) 872-0141 / FAX (206) 872-8710

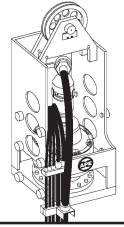

## **- APPENDIX A -** **CUMMINS 6CT8.3 ENGINE**

### **A-1. ENGINE OPERATION INSTRUCTIONS**

The following sections are basic instructions for maintenance and operation of the **APE Model 240 Power Unit Engines**. All maintenance should be performed by qualified personnel who are familiar with the equipment. (Consult the factory for additional information.)

#### **A-1A. PRE-START INSPECTION AND PROCEDURES**

1. Make a "walk-around" inspection of the engine and components for the oil, water or fuel leaks and general appearance. Correct minor adjustments before they develop into major repair jobs.
2. Check the crankcase oil level. Maintain the oil level between the ADD and FULL marks on the dipstick. See OIL SPECIFICATIONS for type of oil to use.
3. Check oil level(s) on driven equipment.

**WARNING: Check the engine coolant level when the engine is cool. If the engine is warm, steam may spray outward under high pressure and cause personal injury.**

4. Check the engine jacket coolant level. Slowly turn the pressure cap until the cap is removed. Maintain coolant level to the base of the fill pipe.
5. Check the fuel supply. Keep fuel tanks full, as partially filled tanks will collect moisture. See the FUEL SPECIFICATIONS for type of fuel.

#### **KEEP THE FUEL SUPPLY CLEAN**

6. Open the raw water valve on the engine jacket heat exchanger system (if so equipped). Prime the raw water pump if the raw water system has been drained.
7. Reset shutoff devices. See the topic, ATTACHMENTS, Emergency Shutoff Devices and Alarms. If the engine is equipped with an air safety shutoff control, and was tripped to the shutoff position, reset the latch to the run position.
8. Open the fuel supply valve. If the engine has not run for some time it may be necessary to prime the system. See the topic, PRIMING THE FUEL SYSTEM.
9. Disconnect any battery charger which is not protected against starting motor drain.
10. Disengage the clutch, or open the circuit breaker on a generator set.



# **OPERATION / MAINTENANCE MANUAL**

MODEL 50 AUGER WITH MODEL 240 POWER UNIT

7032 SOUTH 196th - KENT, WA. 98032 - (206) 872-0141 / FAX (206) 872-8710

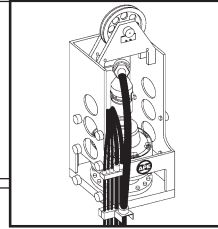

## **- APPENDIX A -** **CUMMINS 6CT8.3 ENGINE**

### **A-1B. STARTING THE ENGINE.**

**CAUTION: Do not engage the starter when the flywheel is moving.**

#### **Electric Starting**

1. Move the governor control lever to approximate half engine speed position.
2. Use starting aids if required.
3. Push the START button; or turn the HEAT START switch to the START position, depending upon the control the engine has. Release the control as soon as the engine starts.

For generator sets, place the AUTO-MAN switch in the MAN position to crank the engine. As soon as the engine starts, and the engine speed reaches 600 rpm and oil pressure is approximately 22 psi (1.5 kg /CM<sup>2</sup>), the starter motor will disconnect from the circuit. (The STOP position is used to stop the diesel engine.)

If the engine fails to start within 10 seconds, move the governor control lever to the fuel off position, then continue to crank for 10 seconds. This will clear the cylinders of unburned fuel.

If the engine fails to start after 30 seconds of cranking, allow the engine to cool for 2 minutes before repeating the starting procedure.

**CAUTION: Prolonged cranking at low oil pressure can activate the mechanical safety shut-off. If the reset lever is in the shut-off position, reset the mechanical shut-off control.**

**CAUTION: NEVER use starting aids when the engine is warm and running.**

#### **Air Starting**

1. Open and close the bleed valve on the bottom of the air tank to drain condensation and oil carryover.
2. Check the air supply pressure. The air start must have 100 PSI (7 kg/cm<sup>2</sup>) to operate properly.
3. Keep oil level, in the oiler jar, at least half full. Add oil if necessary.
4. Push the air valve control in to crank the engine. As soon as the engine starts, release the valve.





# **OPERATION / MAINTENANCE MANUAL**

MODEL 50 AUGER WITH MODEL 240 POWER UNIT

7032 SOUTH 196th - KENT, WA. 98032 - (206) 872-0141 / FAX (206) 872-8710

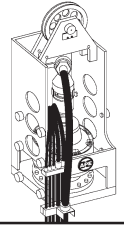

## **- APPENDIX A - CUMMINS 6CT8.3 ENGINE**

### **A-1. OPERATION INSTRUCTIONS. (Continued...)**

#### **A-1C. ENGINE OPERATION.**

After the engine starts, and at frequent intervals while the engine is operating, the gauges should be observed. Determine the normal reading for each gauge. Investigate the cause whenever there is a significant change in the reading.

#### **Tachometer**

The tachometer indicates engine RPM. The high idle RPM and the full load RPM are stamped on the engine's information plate. The engine can be operated between these two speed limits for long periods of time without shortening engine life. Prolonged operation at high idle with little or no load can cause adverse engine operation.

#### **Engine Oil Pressure**

If the gauge reading fluctuates after the load is stable:

1. Remove the load.
2. Reduce engine speed to low idle.
3. Observe the oil level. Maintain the oil level between the ADD and FULL mark on the dipstick. If the reading continues to fluctuate when the oil level is correct, stop engine and call your Caterpillar dealer.

#### **Engine Jacket Water Temperature**

The engine should operate within the NORMAL (green) range. If the engine is operating in the (red) range and steam becomes apparent:

1. Reduce the load and engine RPM.
2. Inspect for coolant leaks.
3. Determine if the engine must be shut down immediately; or if the engine can be safely cooled by reducing the load. (See COOLING SPECIFICATION INSTRUCTIONS.)

**CAUTION: Do not add cold water to a hot engine: Cracking of engine components may occur. Allow the engine to cool, then add coolant.**



# **OPERATION / MAINTENANCE MANUAL**

MODEL 50 AUGER WITH MODEL 240 POWER UNIT

7032 SOUTH 196th - KENT, WA. 98032 - (206) 872-0141 / FAX (206) 872-8710

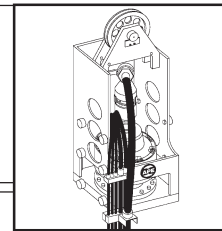

## **- APPENDIX A -** **CUMMINS 6CT8.3 ENGINE**

### **A-1C. ENGINE OPERATION (Continued...)**

#### **Water Temperature Gauge**

If the temperature gauge reading registers in or near the cold range (white) while operating under load:

1. Check the water temperature gauge for accuracy.
2. Check the temperature regulators for proper temperature range. Replace regulators if necessary.

#### **Fuel pressure**

If the fuel filter gauge registers in the OUT range, clean the primary fuel filter, if so equipped. Install new secondary or final fuel filter elements if gauge still registers OUT. See the FUEL MAINTENANCE INSTRUCTIONS and FUEL SPECIFICATIONS.

#### **Ammeter:**

The ammeter reading is normal when the indicator is at or on the (+) side of zero, when the engine is running at rated speed. If indicator is to the left (-) side of zero, investigate and correct cause.

#### **Air Cleaner Service Indicator**

When the gauge indicator locks in the red range, service the air cleaner. With the engine stopped.

#### **Calibrated Gauges**

Calibrated gauges are used on some engines to monitor the engine systems. If an abnormal engine condition develops, determine and analyze and correct the cause before a failure and downtime occurs.

If any of the gauges register at or outside the operating limits, investigate and correct any malfunction. See TROUBLESHOOTING for guidance.

**WARNING: Shut the engine down if work on or around the engine is required.  
DO NOT OPERATE THE ENGINE WITH THE GAUGES REGISTERING AT OR OUTSIDE  
THE LIMITS.**



# **OPERATION / MAINTENANCE MANUAL**

MODEL 50 AUGER WITH MODEL 240 POWER UNIT

7032 SOUTH 196th - KENT, WA. 98032 - (206) 872-0141 / FAX (206) 872-8710

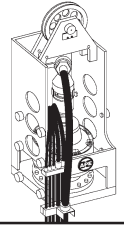

## **- APPENDIX A - CUMMINS 6CT8.3 ENGINE**

### **A-1C. ENGINE OPERATION (Continued...)**

#### **Altitude Operation**

The fuel system settings and altitude limits are stamped on the engine information plate. When an engine is moved to a higher altitude, these settings must be changed by your Caterpillar dealer in order to prevent damaging the turbocharger, and to provide maximum engine efficiency. If the engine is moved to a lower altitude than that which is stamped on the engine information plate, the engine can be operated safely; however, it will deliver less than rated horsepower, and the fuel settings should be changed by your Caterpillar dealer to obtain rated horsepower.

#### **Stopping**

1. Flywheel clutch operation: Quickly pull the clutch lever to the released position.
2. Reduce engine speed to half speed. Run for 5-10 minutes to cool engine.
3. Reduce engine speed to low idle.
4. Observe the crankcase oil level while the engine is idling. Maintain the oil level between the ADD and FULL marks on the side of the dipstick stamped, CHECK WITH ENGINE RUNNING. See the LUBRICATION AND MAINTENANCE SECTION.
5. Stop the engine.

#### **After Stopping Checks And Procedures**

1. Fill the fuel tank. See the LUBRICATION AND MAINTENANCE SECTION: Fuel Tank Maintenance.
2. Drain the raw water system if below freezing temperatures are expected; see: Draining Raw Water System.
3. If below freezing temperatures are expected, allow the engine jacket water expansion tank to cool, then check the coolant for proper antifreeze protection. Add permanent-type antifreeze, if required.
4. Repair any leaks, make major adjustments, tighten loose bolts, etc.
5. Observe the Service Meter reading. Perform the periodic maintenance as instructed in the LUBRICATION AND MAINTENANCE CHART.



# **OPERATION / MAINTENANCE MANUAL**

MODEL 50 AUGER WITH MODEL 240 POWER UNIT

7032 SOUTH 196th - KENT, WA. 98032 - (206) 872-0141 / FAX (206) 872-8710

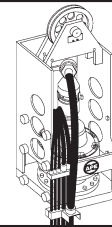

## **- APPENDIX A - CUMMINS 6CT8.3 ENGINE**

### **A-1C. ENGINE OPERATION (Continued...)**

#### **Starting The Engine**

1. Perform all prestart checks outlined previously.
2. Place the CONTROL switch in the MANUAL position to crank the engine.
3. When the engine starts and engine rpm reaches 600 rpm and the oil pressure registers 22 psi (1.5 kg/cm<sup>2</sup>) the starting motor will automatically disconnect from the start circuit.
4. Start the load.
5. Regulate the engine speed with the RAISE/LOWER switch to the required instrument panel gauge readings.

#### **Stopping The Engine**

1. Remove the load.
2. Reduce engine speed to low idle: Push down and hold the RAISE/LOWER switch until the engine low idle speed is reached.
3. While the engine is idling, check the engine oil level. Oil level must be maintained between the ADD and FULL marks on the side of the dipstick marked "CHECK WITH ENGINE RUNNING".
4. Stop the engine.

#### **(Solenoid Shutoff)**

- a. Move the control switch to the STOP or OFF positions. (Do not confuse this with the "RAISE/LOWER" switch.)

#### **(PSG Governor)**

- b. Move the shutoff lever forward, or hold the lever up, depending upon installation. Hold the lever in this position until the engine stops.

5. Fill the fuel tank. See the LUBRICATION AND MAINTENANCE section.
6. Drain the raw water system if below freezing temperatures are expected.

Observe the Service Meter reading. Perform the periodic maintenance as instructed in the LUBRICATION AND MAINTENANCE CHART.



# **OPERATION / MAINTENANCE MANUAL**

MODEL 50 AUGER WITH MODEL 240 POWER UNIT

7032 SOUTH 196th - KENT, WA. 98032 - (206) 872-0141 / FAX (206) 872-8710

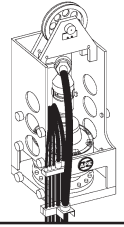

## **- APPENDIX A - CUMMINS 6CT8.3 ENGINE**

### **A-1D. Determining Cause Of Shutdown**

**CAUTION: If the engine has been shutdown by a safety device, don't start the engine and place it into service without having the cause of the shutdown investigated and corrected**

#### **Low Oil Pressure Checks**

If the low oil pressure shutoff control has stopped the engine, make the following checks:

1. Check the water temperature gauge. Determine if the engine was overheated. Check for external water leaks.

**WARNING: Beware of steam or scalding water. Do not attempt to loosen the radiator cap until the temperature gauge indicates the coolant has sufficiently cooled. Then, loosen the cap slowly.**

2. Check the oil level. Oil level must be between the ADD and FULL marks on the side of the dipstick stamped CHECK WITH ENGINE STOPPED.
3. If the oil level is below the ADD mark, check for oil spray and/or oil accumulations. If any are found, have the necessary repairs made. Before starting, add oil to the FULL mark.
4. Reset the shutoff control.
5. Remove the load and start the engine at its slowest speed. Be prepared to shut the engine down manually.
6. Be alert for unusual sounds or noises. If the engine knocks, stop the engine immediately and call your engine dealer.
7. If the engine blows excessive black exhaust or has excessive crankcase blow-by, the engine may need reconditioning. Stop the engine and call your engine dealer.
8. If the engine runs satisfactorily, observe the oil pressure gauge. If satisfactory pressure is not indicated, shut the engine down; call your engine dealer.
9. If proper oil pressure is registered, check to see if the reset knob has moved to the run position. If the knob does not move, stop the engine. Check the shutoff control, the oil line, and the oil pressure gauge. Have necessary repairs made.
10. If the oil pressure gauge registers normal oil pressure, if the knob on the shutoff control moves to the run position, and if the engine operation is otherwise satisfactory, determine if the high water temperature shutoff may have shut down the engine.



# **OPERATION / MAINTENANCE MANUAL**

MODEL 50 AUGER WITH MODEL 240 POWER UNIT

7032 SOUTH 196th - KENT, WA. 98032 - (206) 872-0141 / FAX (206) 872-8710

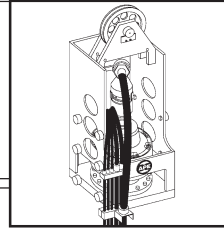

## **- APPENDIX A - CUMMINS 6CT8.3 ENGINE**

### **A-1D. Determining Cause Of Shutdown (Continued...)**

#### **High Water Temperature Checks-Engine Running**

1. Determine if the load was too great for the engine - Reduce the load and allow the engine to cool while running.
2. If pressure steam or water leaks are visible, remove the load and stop the engine. Have necessary repairs made.
3. Check for collapsing or deteriorated water hoses. Have repairs made.
4. Check for noisy water pump operation. Have necessary repairs made.
5. Refill the cooling system with a solution of water and permanent-type antifreeze if below freezing temperatures are expected; or with a solution of approved water and Corrosion Inhibitor. Follow the instructions on the container.

**WARNING: DO NOT remove the pressure cap on an overheated engine. The coolant is under pressure and relieving the pressure will cause the coolant to flash into steam.**

NOTE: If there is adequate coolant in the cooling system, gradual cooling is preferred by running the engine a half speed. This eliminates hot spots in the engine, and possible failure.

#### **High Water Temperature Checks-Engine Stopped and Cold**

1. Check coolant level. Determine if the coolant has proper antifreeze protection. A 50-50 solution of permanent-type antifreeze and approved water will give protection below -200F (-290C).
2. Check to be sure the raw water valve has been opened.
3. Check engine room vents and/or louvers. Be sure the engine is receiving sufficient air.
4. Be sure temperature regulators are operating at proper temperature range.
5. Inspect all water hoses carefully for collapsing, external and internal failures. Replace hoses as required.
6. Have the cooling system cleaned.

**CAUTION: If severe or prolonged overheating has occurred, contact your engine dealer to have your engine checked for possible damage.**



# **OPERATION / MAINTENANCE MANUAL**

MODEL 50 AUGER WITH MODEL 240 POWER UNIT

7032 SOUTH 196th - KENT, WA. 98032 - (206) 872-0141 / FAX (206) 872-8710

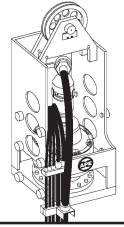

## **- APPENDIX A - CUMMINS 6CT8.3 ENGINE**

### **A-2. MAINTENANCE RECOMMENDATIONS**

**CAUTION: Never add coolant to an overheated engine; allow the engine to cool first.**

#### **Cooling**

Check specific gravity of antifreeze solution frequently in cold weather to assure adequate protection. Coolant should be drained and replaced "Every 2000 Service Meter Units." With additions of Cooling System Inhibitor or the use of Coolant Conditioner Elements as recommended, the drain period can be extended to "Every 4000 Service Meter Units."

All water is corrosive at engine operating temperature. The cooling system should be protected with inhibitor at all times, regardless of concentration of antifreeze. This can be done by maintaining a 3% concentration of liquid Cooling System Inhibitor or by using Coolant Conditioner Elements.

Never use both the liquid cooling system inhibitor and coolant elements at the same time.

Do not use Cooling System Inhibitor or Coolant Conditioner Elements with Dowtherm 209 Full-Fill Coolant.

Whenever draining and refilling cooling system, always recheck the coolant level when the engine reaches normal operating temperature.

Filling at over 5 U.S. gallons (19 liters) per minute can cause air pockets in the cooling system.

Premix antifreeze solution to provide protection to the lowest expected ambient temperature. Pure undiluted antifreeze will freeze at -100F (-23,C).

Operate with a thermostat in the cooling system all year-round. Cooling system problems can arise without a thermostat.

#### **Electrical**

**CAUTION: When using jumper cables to start the engine, be sure to connect in parallel: POSITIVE (+) to POSITIVE (+) and NEGATIVE (-) to NEGATIVE (-)**

#### **Scheduled Oil Sampling**

Use scheduled Oil sampling to monitor the engine's condition and maintenance requirements. Each oil sample should be taken when the oil is hot, and well mixed, to insure a sample which is representative of the oil in the compartment.

Consult your engine dealer for complete information and assistance in establishing a Scheduled Oil Sampling program for your equipment.



# **OPERATION / MAINTENANCE MANUAL**

MODEL 50 AUGER WITH MODEL 240 POWER UNIT

7032 SOUTH 196th - KENT, WA. 98032 - (206) 872-0141 / FAX (206) 872-8710

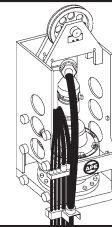

## **- APPENDIX A -** **CUMMINS 6CT8.3 ENGINE**

### **A-2. MAINTENANCE RECOMMENDATIONS (Continued...)**

#### **Fuel**

**CAUTION: Fill fuel tank at the end of each day of operation to drive out moisture laden air and to prevent condensation. Do not fill the tank to the brim. The fuel expands when it gets warm and may overflow.**

Water and sediment should be drained from the fuel tank at the start of each shift or after the fuel tank has been filled and allowed to stand for 5 to 10 minutes.

Drain fuel tank of moisture and sediment as required by prevailing conditions.

After changing fuel filters, always bleed fuel system to remove air bubbles from system.

#### **Air intake**

Service air cleaners when RED band in indicator locks in visible position.

### **A-2A. LUBRICATION SPECIFICATIONS**

#### **Crankcase Lubricating Oils**

Use oils which meet Engine Service Classification (MIL-L-2104D) or CD/TO-2. These are additive-type oils that have been approved for use in Diesel Engines.

Consult the "EMA Lubricating Oils Data Book", Form SEBU5939, for a listing of CD oil brands.

The proper SAE grade of oil to select is determined by the ambient temperature at which the engine is started and the maximum ambient temperature in which the engine will be operating. To determine if the oil in the crankcase will flow in cold weather, remove the oil dipstick before starting. If the oil will flow off, the oil is fluid enough to circulate properly.

#### **Lubricating Grease**

Use Multipurpose-type Grease (MPGM) which contains 3-5% molybdenum disulfide conforming to MIL-M-7866, and a suitable corrosion inhibitor. NLGI No.2 Grade is suitable for most temperatures. Use NLGI No. 0 or No. 1 Grade for extremely low temperatures.





# **OPERATION / MAINTENANCE MANUAL**

MODEL 50 AUGER WITH MODEL 240 POWER UNIT

7032 SOUTH 196th - KENT, WA. 98032 - (206) 872-0141 / FAX (206) 872-8710

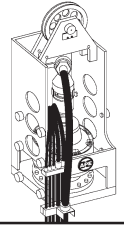

## **- APPENDIX A - CUMMINS 6CT8.3 ENGINE**

### **A-2. MAINTENANCE RECOMMENDATIONS (Continued...)**

#### **A-2B. FUEL SPECIFICATIONS**

No. 2 fuel oil and No. 2D diesel fuel are recommended for use in Diesel Engines. In extreme cold temperatures use No. 1 fuel oil or No.1 D diesel fuel.

In selecting a fuel, note that distillate fuels are especially desirable because the fuel is heated to a vaporous state and condensed, thus eliminating all sediment and residue.

#### **A-2C. COOLANT SPECIFICATIONS**

Water used in the jacket water cooling system should be clean, and as free as possible from scale forming minerals or corrosive chemicals. Artificially softened water should not be used. Treating the water with Coolant Inhibitor, or equivalent will help prevent the formation of rust and pitting. It will also retard, and in some cases completely eliminate, mineral deposits in the engine.

The most efficient and satisfactory corrosion protection for the cooling system is to maintain proper level of coolant inhibitor and antifreeze solution. The use of auxiliary water filters is not recommended.

During freezing weather use the proper permanent type antifreeze and water solution to prevent freezing.

Before placing the engine in operation, make sure a 3% concentration of Corrosion Inhibitor has been added to the cooling system. This 3% concentration must be maintained in cooling systems which are filled with water and systems protected with ethylene glycol antifreeze mixture, regardless of antifreeze concentration.

**WARNING: Inhibitors contain alkali. Avoid contact with eyes. To prevent personal injury, avoid prolonged or repeated contact with skin.**



# OPERATION / MAINTENANCE MANUAL

MODEL 50 AUGER WITH MODEL 240 POWER UNIT

7032 SOUTH 196th - KENT, WA. 98032 - (206) 872-0141 / FAX (206) 872-8710

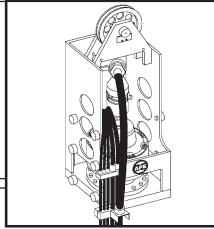

## - APPENDIX A - CUMMINS 6CT8.3 ENGINE

### A-2. MAINTENANCE RECOMMENDATIONS (Continued...)

#### A-2D. LUBRICATION AND MAINTENANCE

The LUBRICATION AND MAINTENANCE CHART lists all serviceable items commonly ordered on this engine. The maintenance tune intervals are expressed in "Operating Hours".

Daily	Weekly	250 Hours or 6 months	1500 Hours or 1 Year	6000 Hours or 2 Years	6000 Hours or 3 Years
<ul style="list-style-type: none"> <li>• Check operator's report</li> <li>• Check and bring to correct level               <ul style="list-style-type: none"> <li>- Engine Oil</li> <li>- Coolant</li> </ul> </li> <li>• Visually inspect fan.</li> <li>• Visually inspect engine for damage, leaks, loose or frayed belts and correct or record for future action.</li> <li>• Drain fuel-water separator.</li> </ul>	<p><b>Repeat Daily Check</b></p> <ul style="list-style-type: none"> <li>• Check air intake system for wear points or damage to piping, loose clamps, and leaks.</li> <li>• Check air cleaner restriction.</li> <li>• Check and clean air cleaner element.</li> <li>• Drain moisture from air tanks.</li> </ul>	<p><b>Repeat Daily and Weekly Check</b></p> <ul style="list-style-type: none"> <li>• Change Lubricating Oil.</li> <li>• Change Lubricating Oil Filters.</li> <li>• Change Fuel Filter.</li> <li>• Change Coolant Filter.</li> <li>• Clean Crankcase Breather.</li> <li>• Check engine coolant concentration level. Add make-up if required.</li> <li>• Replace final Fuel Filter/Clean primary Fuel Filter. Drain water from fuel tank.</li> <li>• Inspect/Replace Alternator, Fan and Accessory Drive</li> <li>• Belts. Inspect/Replace</li> <li>• Hoses and Clamps. Lubricate Fan Drive</li> <li>• Bearings. Clean/Check Battery electrolyte level.</li> </ul>	<p><b>Repeat Previous Intervals</b></p> <ul style="list-style-type: none"> <li>• Adjust valves and injectors.</li> <li>• Steam clean engine.</li> <li>• Check torque on turbocharger mounting nuts.</li> <li>• Check torque on engine mounting bolts.</li> <li>• Replace hoses as required.</li> <li>• Check/Adjust engine valve lash.</li> <li>• Check/Adjust low idle speed.</li> <li>• Test/Exchange fuel injection nozzles.</li> <li>• Inspect coolant pump. Clean cooling system. (Internal)</li> <li>• Inspect/Rebuild Alternator.</li> </ul>	<p><b>Repeat Previous Intervals</b></p> <ul style="list-style-type: none"> <li>• Clean cooling system and change coolant and antifreeze.</li> <li>• Inspect temperature regulator.</li> <li>• Inspect/Rebuild turbocharger.</li> <li>• Inspect/Rebuild starter.</li> <li>• Check and adjust clutch.</li> </ul>	<p><b>Repeat Previous Intervals Which Are Due</b></p> <ul style="list-style-type: none"> <li>• Clean and calibrate the following: (Rebuild or exchange if required.)               <ul style="list-style-type: none"> <li>- Injectors.</li> <li>- Fuel pump.</li> <li>- Air compressor.</li> <li>- Fan clutch.</li> <li>- Water pump.</li> <li>- Fan hub.</li> <li>- Fan idler pulley assembly.</li> <li>- Vibration damper.</li> </ul> </li> </ul>
<p>Follow the manufacturer's recommended maintenance procedures for the starter, alternator, generator, batteries, electrical components, engine brake, exhaust brake, air compressor, freon compressor, and fan clutch. At each scheduled maintenance interval, perform all previous maintenance checks which are due for scheduled maintenance.</p>					



# **OPERATION / MAINTENANCE MANUAL**

MODEL 50 AUGER WITH MODEL 240 POWER UNIT

7032 SOUTH 196th - KENT, WA. 98032 - (206) 872-0141 / FAX (206) 872-8710

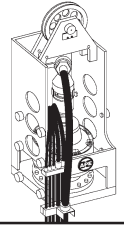

## **- APPENDIX A - CUMMINS 6CT8.3 ENGINE**

### **A-2E. ELECTRICAL SYSTEM**

The following topics describe care and maintenance of the electrical system components. These components functioning together produce the energy needed for operating the electrical equipment on the engine and each is dependent upon the others for satisfactory operation. In the event of failure or improper operation, it is essential to check the entire electrical system as a defect in one component can cause damage to another. Many electrical system problems can be traced to loose or corroded connections. Keep connections tight and make sure the wiring insulation is in satisfactory condition. Most of the electrical system testing can be performed while the components are on the engine. It should be remembered, if a malfunction is found on test, the component must be removed for further testing, repair or replacement.

#### **Battery**

Every 250 hours check the electrolyte level of each cell and the general condition of the battery. Maintain the electrolyte level to the base of each vent well. The make-up water must be one of the following (in order of preference):

1. Distilled water.
2. Odorless, tasteless drinking water.
3. Iron free water.

**WARNING: Never add acid or electrolyte.**

#### **Cleaning Battery**

Mix a weak solution of baking soda and water. Apply the solution with a soft bristle brush. Be careful not to get cleaning solution into the battery. Thoroughly rinse the battery and battery tray with clean water. Apply grease to battery cable clamps and terminals and to all threads.

#### **Installing Battery**

1. Be sure the battery tray is clean and free of foreign objects.
2. Be sure terminal posts and cable clamps are clean.
3. Place the battery in the tray. Tighten the hold down clamps evenly until the battery is snug. Do not over tighten.
4. Connect the "hot" terminal first. Be sure the top of the cable terminal is pushed down even with the top of the terminal post. Tighten the clamp firmly.

**WARNING: Always connect the "hot" terminal first to minimize arcing. Otherwise injury or damage could result.**

5. Connect the "grounded" terminal last. Be sure the top of the cable terminal is pushed down even with the top of the terminal post. Tighten the clamp firmly.
6. Apply a thin coating of grease over the cable clamps, terminals and hold down fasteners.



# OPERATION / MAINTENANCE MANUAL

MODEL 50 AUGER WITH MODEL 240 POWER UNIT

7032 SOUTH 196th - KENT, WA. 98032 - (206) 872-0141 / FAX (206) 872-8710



## - APPENDIX A - CUMMINS 6CT8.3 ENGINE

### A-2E. ELECTRICAL SYSTEM (Continued...)

#### Charging the Battery

**WARNING: Never smoke in the area where batteries are being charged. Hydrogen gas is given off at each vent cap during charging. Hydrogen mixed with air is highly explosive.**

1. Connect positive charger clamp to positive battery terminal.
2. Connect negative charger clamp to negative battery terminal.
3. Connect charger power cord to proper outlet.
4. Allow battery to charge slowly.

**CAUTION: If battery is charged too rapidly, the battery will be damaged.**

5. After the battery is charged, disconnect charger power cord from outlet; remove charger clamp from negative battery terminal; remove charger clamp from positive battery terminal.

### A-3. Engine Troubleshooting.

#### -TROUBLESHOOTING INDEX-

ITEM	PROBLEM	ITEM	PROBLEM
1.	Engine Fails to Start	15.	Valve Lash Close-up
2.	Misfiring	16.	Premature Engine Wear
3.	Erratic Engine Speed	17.	Coolant in Engine Lubricating Oil
4.	Low Power	18.	Excessive Black or Gray Smoke
5.	Excessive Vibration	19.	Excessive White or Blue Smoke
6.	Heavy Combustion Knock	20.	Low Engine Oil Pressure
7.	Valve Train Clicking Knock	21.	High Lubricating Oil Consumption
8.	Oil in Coolant	22.	Abnormal Engine Coolant Temperature
9.	Mechanical Knock	23.	Starting Motor Fails to Crank
10.	Excessive Fuel Consumption	24.	Alternator Fails to Charge
11.	Loud Valve Train Noise	25.	Alternator Charging Rate Low or Unsteady
12.	Excessive Valve Lash	26.	Alternator Charging Rate High
13.	Valve Spring Retainer Free	27.	Alternator Noisy
14.	Slobber		



# OPERATION / MAINTENANCE MANUAL

MODEL 50 AUGER WITH MODEL 240 POWER UNIT

7032 SOUTH 196th - KENT, WA. 98032 - (206) 872-0141 / FAX (206) 872-8710

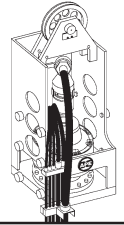

## - APPENDIX A - CUMMINS 6CT8.3 ENGINE

### A-3. Engine Troubleshooting. (Continued...)

Possible Causes	Remedy
<b>1. ENGINE FAILS TO START</b>	
No Fuel to Engine	Check for empty fuel tank, plugged fuel tank connections, obstructed or kinked fuel suction lines, fuel transfer pump failure, or plugged fuel filters.
Shutoff Solenoid Sticking*	Solenoid must be energized to shut off engine. Actuate the control that operates the shutoff solenoid and listen for a clicking sound. If clicking sound is not evident and engine will not start, remove the solenoid. Again try to start the engine. If the engine starts, the solenoid is bad. Replace the solenoid.
Fuel Transfer Pump	At cranking speed, the fuel transfer pump should supply fuel to the engine at 3 PSI (20 kPa). If fuel pressure is less than 3 PSI (20 kPa), replace the fuel filter. Check for air in fuel system, sticking, binding or defective fuel bypass valve. If pressure is still low, replace the fuel transfer pump.
Engine Improperly Timed	See your authorized dealer.
Glow Plug Failure	Check glow plugs.
Automatic and Safety Shutoff Controls	Check shutoff controls to ensure they are set properly. See Starting Procedures.
*Optional Equipment	
<b>2. MISFIRING</b>	
Defective Fuel Injection Nozzle or Fuel Pump	Run the engine at the speed where the defect is most pronounced. Momentarily loosen the fuel line nut on the injection pump to "cut out" that cylinder. Check each cylinder in this manner. If one is found where loosening makes no difference in irregular operation, the pump and nozzle for only that cylinder need be treated.
Improper Valve Lash	Set to specified clearance.
Incorrect Fuel Injection Timing	See your authorized dealer.
Low Fuel Supply Pressure	Check fuel supply line for leaks or kinks, air in fuel system, sticking, binding, or defective fuel bypass valve. Replace fuel filter. Check fuel pressure. Fuel transfer pump should supply fuel at 20 to 30 PSI (1.4 to 2.1 kg/CM <sup>2</sup> ) to the engine when the engine is fully loaded.
Broken or Leaking High Pressure Fuel Line	Replace the line.
Air in Fuel System	Find source of air entry and correct. Bleed system.
Bent or Broken Push Rod	Replace push rod.



# OPERATION / MAINTENANCE MANUAL

MODEL 50 AUGER WITH MODEL 240 POWER UNIT

7032 SOUTH 196th - KENT, WA. 98032 - (206) 872-0141 / FAX (206) 872-8710

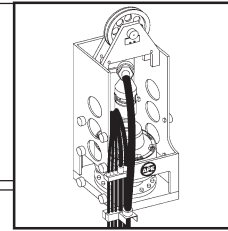

## - APPENDIX A - CUMMINS 6CT8.3 ENGINE

### A-3. Engine Troubleshooting. (Continued...)

Possible Causes	Remedy
<b>3. ERRATIC ENGINE SPEED</b>	
Governor Control Linkage	Adjust external linkage to obtain sufficient travel. Replace if damaged, bent, or linkage is too short.
Governor Failure	Look for damaged or broken springs, linkage, or other components. Determine if the rack can be moved manually. If any distress is noted in any of these components, replace as necessary.*
<b>4. LOW POWER</b>	
Fuel Nozzle Failure	Run the engine at the speed where the defect is most pronounced. Momentarily loosen the fuel line nut on the injection pump to "cut out" that cylinder. Check each cylinder in this manner. If one is found where loosening makes no difference in irregular operation, the pump and nozzle for only that cylinder need be tested.
Poor Quality Fuel	Drain, clean and bleed fuel system. Replace fuel filter. Fill fuel tank with proper grade of fuel.
Turbocharger Carboned or Otherwise Dragging	Inspect and repair or replace turbo charger as necessary.*
Leaks in Air Induction System	Check inlet manifold pressure. Check air cleaner for restriction.
Incorrect Fuel Injection Timing	See your authorized dealer.
Excessive Valve Lash	Set to specified clearance.
Low Fuel Supply Pressure	Check fuel supply line for leaks or kinks, air in fuel system, sticking, binding or defective fuel bypass valve. Replace fuel filter. Check fuel pressure. Fuel transfer pump should supply fuel to 20 to 30 PSI(1.4 to 2.1kg/CM2)to
<b>5. EXCESSIVE VIBRATION</b>	
Loose, Worn or Defective Engine Mounts as necessary.	Tighten all mounting bolts securely. Replace components as necessary.
Loose Pulley and Damper	Retighten.
Loose or Worn Coupling on Driven Equipment	Inspect, align and tighten coupling to driven equipment.
Defective Damper or Pulley	Replace damper or pulley.
Misfiring	See ITEM 2.



# **OPERATION / MAINTENANCE MANUAL**

**MODEL 50 AUGER WITH MODEL 240 POWER UNIT**

**7032 SOUTH 196th - KENT, WA. 98032 - (206) 872-0141 / FAX (206) 872-8710**

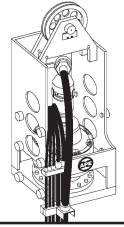

## **- APPENDIX A - CUMMINS 6CT8.3 ENGINE**

### **A-3. Engine Troubleshooting. (Continued...)**

<b>Possible Causes</b>	<b>Remedy</b>
<b>6. HEAVY COMBUSTION KNOCK</b>	
Air in Fuel System	Bleed air from system.
Defective Fuel Injection Pump Plunger and Barrel Assembly	Replace.*
Defective Fuel Injection Nozzle	Replace.
Incorrect Fuel Injection Timing	See your authorized dealer.*
<b>7. VALVE TRAIN CLICKING NOISE</b>	
Excessive Valve Lash	Set to specified clearance.
Broken Valve Spring(s)	Replace valve spring(s) and all other damaged components.*
Insufficient Lubrication	Check lubrication in valve compartment. Should be very wet at all speeds. Oil passages should be cleaned, especially those leading to the cylinder head.
<b>8. OIL IN COOLANT</b>	
Failed Oil Cooler Core	Replace oil cooler core.
Failed Head or Spacer Plate Gaskets	Replace head and spacer plate gaskets.
Cracked or Defective Cylinder Block	Replace cylinder block.*
Cracked or Defective Head	Replace cylinder head.
<b>9. MECHANICAL KNOCK</b>	
Engine Connecting Rod Bearing Failure	Replace the bearing. Check the connecting rod and crankshaft. Replace if necessary.*
Main Bearing Failure	Replace bearings.*
Damaged Timing Gear Train	Replace components as necessary.*
Broken Crankshaft	Replace crankshaft.*
Fuel Dilution of Crankcase Oil	Correct fuel leakage into crankcase oil.

\*Authorized dealers are equipped with the necessary tools and personnel familiar with disassembly procedures to perform these services.



# **OPERATION / MAINTENANCE MANUAL**

**MODEL 50 AUGER WITH MODEL 240 POWER UNIT**

**7032 SOUTH 196th - KENT, WA. 98032 - (206) 872-0141 / FAX (206) 872-8710**

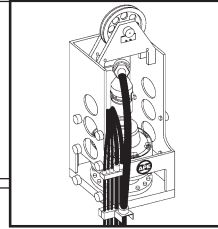

## **- APPENDIX A -** **CUMMINS 6CT8.3 ENGINE**

### **A-3. Engine Troubleshooting. (Continued...)**

#### **Possible Causes**

#### **Remedy**

#### **10. EXCESSIVE FUEL CONSUMPTION**

Fuel System Leaks	Large changes in fuel consumption may result. Internal leaks will probably be accompanied by low engine oil pressure and increased oil level in the engine oil sump. Replace leaking components.
Fuel and Combustion Knock	Small but measurable increases in fuel consumption maybe the result of defective fuel nozzles, misfiring or factors contributing to loss of power. See ITEM 2 and ITEM 5.
Incorrect Fuel Injection Timing	See your authorized dealer.

#### **11. LOUD VALVE TRAIN NOISE**

Bent or Broken Valves	Replace damaged parts.*
Broken Camshaft	Replace all damaged parts. Clean engine thoroughly.
Broken or Severely Worn Valve Lifters	Replace camshaft and valve lifters. Check for sticking valves and bent valve stems. Clean engine thoroughly. Set valve lash to specified clearance.

#### **12. EXCESSIVE VALVE LASH**

Severely Worn Cam Lobes	Check valve lash. Replace camshaft and followers. Clean engine thoroughly. Set valve lash to specified clearance.
Broken or Severely Worn Valve Lifters	Replace valve lifters. Check camshaft for wear. Check for sticking valves and bent valve stems. Clean engine thoroughly. Set valve lash to specified clearance.
Valve Tip Wear	Set valve lash to specified clearance. If wear is excessive, replace valve.
Moderate Valve Lifter Face Wear	Set valve lash to specified clearance. If wear is excessive, replace valve lifter.
Push Rod Wear	Set valve lash to specified clearance. If wear is excessive, replace push rod.
Rocker Arm Anvil Wear	Set valve lash to specified clearance. If wear is excessive, replace rocker arm.
Insufficient Lubrication	Check lubrication in valve should be very wet at high idle speeds, but only damp at low idle. Oil passages should be cleaned, especially those leading to the cylinder head.





# **OPERATION / MAINTENANCE MANUAL**

MODEL 50 AUGER WITH MODEL 240 POWER UNIT

7032 SOUTH 196th - KENT, WA. 98032 - (206) 872-0141 / FAX (206) 872-8710

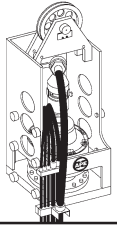

## **- APPENDIX A - CUMMINS 6CT8.3 ENGINE**

### **A-3. Engine Troubleshooting. (Continued...)**

<b>Possible Causes</b>	<b>Remedy</b>
<b>13. VALVE SPRING RETAINER FREE</b>	
Broken Keepers	Extensive engine damage may result from dropped valve. Replace all damaged parts.*
Broken Valve Spring	Replace valve spring.*
Broken Valve	Replace valve and any other damaged parts.*
<b>14. SLOBBER</b>	
Excessive Valve Guide Wear	Recondition cylinder head assembly.*
Excessive Lubricating Oil in Valve compartment.	Check rocker arm shaft and plugs to assure that they are in place.
Worn Piston Rings and/or Liners	Inspect and replace components as necessary.*
<b>15. VALVE LASH CLOSE-UP</b>	
Valve Face and/or Seat Wear	Adjust valves to specified clearance. Recondition cylinder head.
<b>16. PREMATURE ENGINE WEAR</b>	
Intake Piping Failure (Air Cleaner)	Inspect all gaskets and piping for leaks. Repair all leaks.
Excessive Fuel Dilution of Lubricating Oil	Replace leaking components. This will probably be accompanied by high fuel consumption and low engine oil pressure. Tighten fuel injection line fittings under valve cover.
Dirt in Lubricating Oil	Locate and correct source of dirt entry, Change lubricating oil. Change oil filter.
<b>17. COOLANT IN ENGINE LUBRICATING OIL</b>	
Oil Cooler Failure	Replace oil cooler core.
Cylinder Head Gasket Failure	Replace gasket. Maintain proper torque on cylinder head bolts.
Cracked or Defective Cylinder Head	Replace cylinder head.*
Cracked or Defective Cylinder Block	Replace cylinder block.*

\*Authorized dealers are equipped with the necessary tools and personnel familiar with disassembly and assembly procedures to perform these serviced.



# OPERATION / MAINTENANCE MANUAL

MODEL 50 AUGER WITH MODEL 240 POWER UNIT

7032 SOUTH 196th - KENT, WA. 98032 - (206) 872-0141 / FAX (206) 872-8710

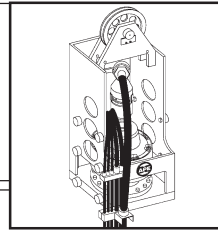

## - APPENDIX A - CUMMINS 6CT8.3 ENGINE

### A-3. Engine Troubleshooting. (Continued...)

#### Possible Causes

#### Remedy

#### 17. COOLANT IN ENGINE LUBRICATING OIL (Cont'd)

Cylinder Liner Seal Leaking	Replace seals.*
Cracked or Defective Cylinder Liners	Replace cylinder liners.'

#### 18. EXCESSIVE BLACK OR GRAY SMOKE

Insufficient Combustion Air	Check air cleaner for restriction. Check inlet manifold pressure. Inspect turbocharger for proper operation.
Fuel Nozzle Plugged or Leaking	Replace nozzle.
Incorrect Fuel Injection Timing	See your authorized dealer.
Fuel Ratio Control Improperly Adjusted	Adjust fuel ratio control.*

#### 19. EXCESSIVE WHITE OR BLUE SMOKE

Valve Guides Worn	Recondition cylinder head assembly.*
Piston Rings Worn, Stuck or Broken	Replace.*
High Crankcase Oil Level	Avoid overfilling. Determine cause and drain excess oil.
Misfiring	See ITEM 2.
Fuel Injection Pump Timing Wrong	See your authorized dealer.
Air in Fuel System	Bleed fuel system.

#### 20. LOW ENGINE OIL PRESSURE

Engine Oil Diluted with Fuel Oil	Check lip-type seal on fuel transfer pump drive shaft. Drain crankcase and refill with clean lubricant.
Excessive Crankshaft Bearing Clearance	Replace bearings and/or crankshaft.* Check oil filter operation.
Excessive Timing Gear Bearing Clearances	Inspect bearings and replace components as necessary.
Excessive Rocker Arm Bore or Rocker Arm Shaft Wear	Check lubrication. Replace components as necessary.
Defective Oil Pump	Repair or replace.*
Defective Suction Bell	Replace.



# **OPERATION / MAINTENANCE MANUAL**

**MODEL 50 AUGER WITH MODEL 240 POWER UNIT**

7032 SOUTH 196th - KENT, WA. 98032 - (206) 872-0141 / FAX (206) 872-8710

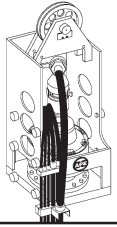

## **- APPENDIX A - CUMMINS 6CT8.3 ENGINE**

### **A-3. Engine Troubleshooting. (Continued...)**

<b>Possible Causes</b>	<b>Remedy</b>
<b>20. LOW ENGINE OIL PRESSURE (Cont'd)</b>	
Clogged Oil Filter or Cooler	Repair or replace as necessary.
Oil Pump Relief Valve Stuck	Clean valve and housing. Replace if necessary.
<b>21. HIGH LUBRICATING OIL CONSUMPTION</b>	
Oil Leaks	Replace gaskets or seals and tighten all connections.
Excessive Oil to Intake	See ITEM 15. Valve Guides.
Excessive Valve Guide Wear	See ITEM 15.
Crankcase Oil Level Too High	Avoid overfilling. Determine cause and drain excess oil.
High Oil Temperature	Check oil cooler bypass valve. Replace if defective. Clean oil cooler core.
Worn Piston Rings and/or Liner	Replace components as necessary.*
<b>22. ABNORMAL ENGINE COOLANT TEMPERATURE</b>	
Combustion Gases in Coolant	Determine point at which gases enter the system. Repair or replace components as necessary.
Defective Water Temperature Regulator or Temperature Gauge	Check temperature regulator for proper opening temperature and correct installation. Check temperature gauge. Replace if necessary.
Coolant Level Low	Determine cause-replace leaking gaskets and hoses. Tighten connections. Add coolant.
Air Flow Through Radiator Restricted	Remove all debris from outer surface of radiator.
Defective Water Pump	Check water pump impeller. Repair water pump as necessary.
Radiator Small for Engine Application	Install correct size radiator.
Fan Improperly Positioned in Shroud or Not Shrouded	Position fan correctly.*

\*Authorized dealers are equipped with the necessary tools and personnel familiar with disassembly and assembly procedures to perform these serviced.



# **OPERATION / MAINTENANCE MANUAL**

MODEL 50 AUGER WITH MODEL 240 POWER UNIT

7032 SOUTH 196th - KENT, WA. 98032 - (206) 872-0141 / FAX (206) 872-8710

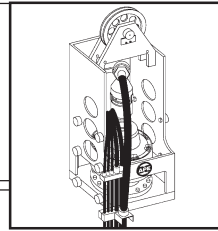

## **- APPENDIX A - CUMMINS 6CT8.3 ENGINE**

### **A-3. Engine Troubleshooting. (Continued...)**

#### **Possible Causes**

#### **Remedy**

#### **22. ABNORMAL ENGINE COOLANT TEMPERATURE**

Incorrect Fuel Injection Timing

See your authorized dealer.

Incorrect Water Piping Connections  
from Engine to Radiator

Check shunt line (if equipped) and  
vent line for correct installation.

#### **23. STARTING MOTOR FAILS TO CRANK**

Low Output from Battery

Check battery and charge or replace.

Defective Wiring or Switch

Repair or replace.

Defective Solenoid

Replace.

Defective Starting Motor

Repair.

#### **24. ALTERNATOR FAILS TO CHARGE**

Drive Belt Loose

Adjust belt.

Open or High Resistance in  
Charging or Ground Return  
Circuits or Battery Connections

Inspect all cables and connectors.  
Clean, re tighten or replace defective  
parts.

Excessively Worn, Open or  
Defective Brushes

Replace brush assembly.\*

Open Rotor Field Coil

Replace rotor assembly.\*

#### **25. ALTERNATOR CHARGING RATE LOW OR UNSTEADY**

Drive Belt Loose

Adjust belt.

Intermittent or High Resistance in  
Charging or Ground Return Circuits  
or Battery Connections

Inspect all cables and connectors.  
Clean, re tighten or replace defective  
parts.

Excessively Worn, Sticky, or  
Defective Brushes

Replace brush assembly.\*

Faulty Regulator

Replace regulator.\*

Shorted or Open Rectifier Diodes

Replace defective rectifier diode  
assembly in alternator.\*

Grounded or Shorted Rotor

Replace rotor assembly.\*



# **OPERATION / MAINTENANCE MANUAL**

**MODEL 50 AUGER WITH MODEL 240 POWER UNIT**

**7032 SOUTH 196th - KENT, WA. 98032 - (206) 872-0141 / FAX (206) 872-8710**

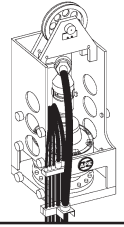

## **- APPENDIX A -** **CUMMINS 6CT8.3 ENGINE**

### **A-3. Engine Troubleshooting. (Continued...)**

<b>Possible Causes</b>	<b>Remedy</b>
<b>26. ALTERNATOR CHARGING RATE HIGH</b>	
Loose Connections	Tighten connections to alternator and regulator.
Defective Regulator	Replace regulator.
<b>27. ALTERNATOR NOISY</b>	
Defective Drive Belt	Replace belt.
Misaligned Belt or Pulley	Align drive pulley, alternator pulley and belt.
Loose Pulley	Tighten pulley nut. If keyway is worn, install a new pulley.
Worn Bearings	Replace bearings.
Shorted Rectifiers in Alternator	Replace diode assembly.*
Armature or Rotor Shaft Bent	Replace component.*

\*Authorized dealers are equipped with the necessary tools and personnel familiar with disassembly and assembly procedures to perform these serviced.



# OPERATION / MAINTENANCE MANUAL

MODEL 50 AUGER WITH MODEL 240 POWER UNIT

7032 SOUTH 196th - KENT, WA. 98032 - (206) 872-0141 / FAX (206) 872-8710

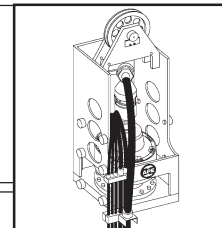

This drive hub fits on the bottom of the drill.  
Call (206) 624-7066 and ask for Wes Schultz for auger flighting or measurements.

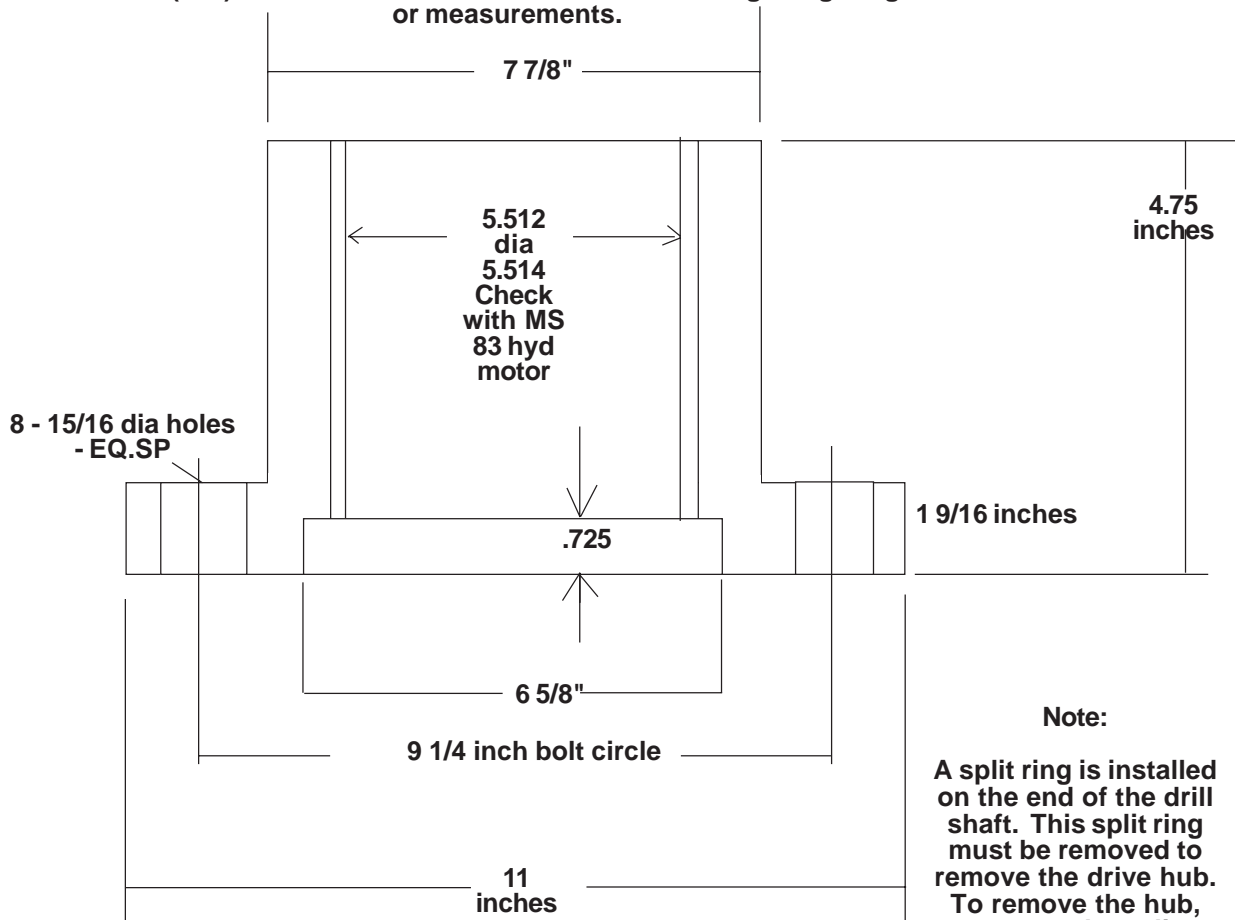

**Note:**

A split ring is installed on the end of the drill shaft. This split ring must be removed to remove the drive hub. To remove the hub, remove the split retainer mounted on top of the hub, then push the hub further onto the drive shaft to expose the bottom split ring. Remove the split ring and then slide the hub off the shaft. Reverse for installation.

Internal Spline data:	No. Teeth	28
Module		5 mm
P.D.		140.0 mm
P.A.		30 degrees
Pin Diameter		9 mm (.3543)
Between Pins		5.162 - 5.165
Material		H.R. 4340
machining surfaces		125 F.A.O.

Note: Int. Spline to fit Poclain MS 83

APE DRIVE HUB FOR MODEL 50 AND MODEL 75 DRILL DRAWING B0996-00



# OPERATION / MAINTENANCE MANUAL

MODEL 50 AUGER WITH MODEL 240 POWER UNIT

7032 SOUTH 196th - KENT, WA. 98032 - (206) 872-0141 / FAX (206) 872-8710

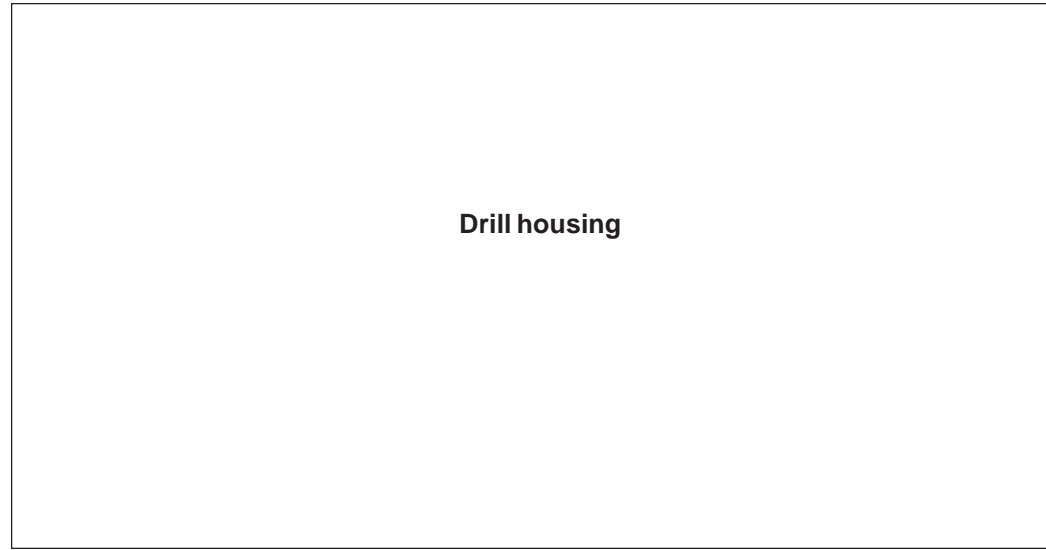
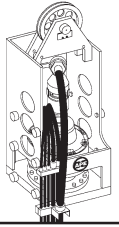

Drill housing



Base of drill motor housing

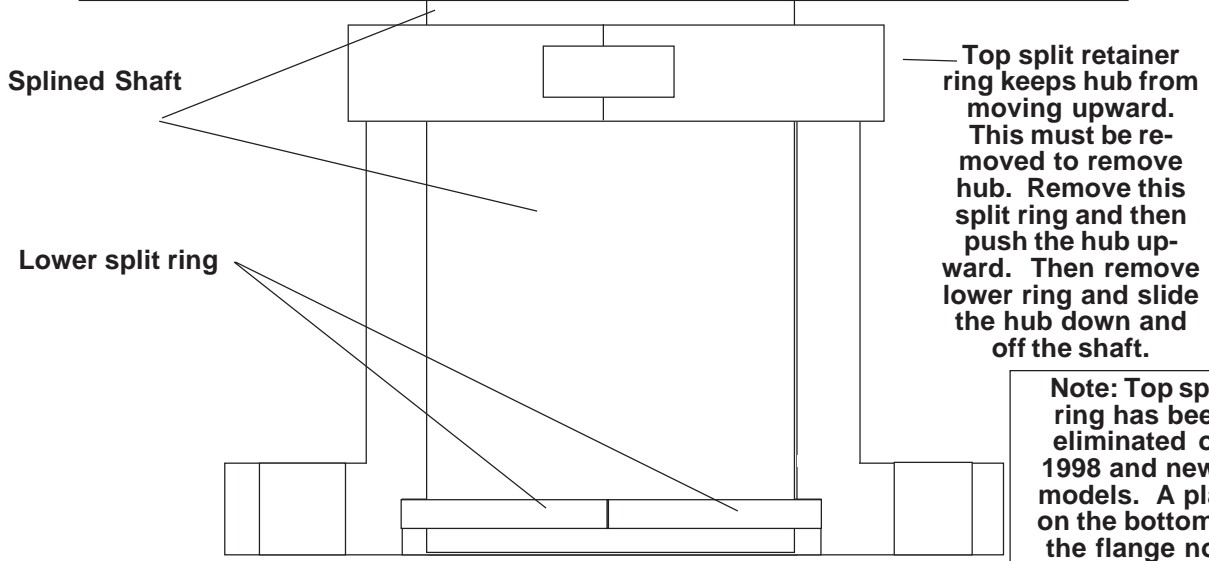

Splined Shaft

Lower split ring

Top split ring keeps hub from moving upward. This must be removed to remove hub. Remove this split ring and then push the hub upward. Then remove lower ring and slide the hub down and off the shaft.

Note: Top split ring has been eliminated on 1998 and newer models. A plate on the bottom of the flange now serves the same purpose.

Shaft should be slightly recessed.

Split ring keeps drive hub from slipping off the shaft. You must remove the split ring retainer above and then push the drive hub further onto the shaft to expose the split ring for removal. Once the lower split ring is removed, then you can remove the drive hub.